

DISSERTATION FOR DOCTORAL (PHD) DEGREE

Le Duong Hung Anh

University of Sopron
Faculty of Wood Engineering and Creative Industries
Sopron
2023

DISSERTATION FOR DOCTORAL (PhD) DEGREE

University of Sopron

Faculty of Wood Engineering and Creative Industries,
József Cziráki Doctoral School of Wood Sciences and Technologies



**Development of new insulation material from sugarcane bagasse and examination
of the insulation effect depending on temperature and humidity**

in

Material Science and Technology

PhD Program: Wood Sciences and Technologies

Author: Le Duong Hung Anh

Supervisor: Dr. Zoltán Pásztory, Assoc. Professor

Sopron, Hungary

2023

**DEVELOPMENT OF NEW INSULATION MATERIAL FROM SUGARCANE
BAGASSE AND EXAMINATION OF THE INSULATION EFFECT DEPENDING ON
TEMPERATURE AND HUMIDITY**

Dissertation for doctoral (PhD) degree
University of Sopron
József Cziráki Doctoral School of Wood Sciences and Technologies

“Wood Sciences and Technologies” programme

Written by:

Le Duong Hung Anh

Made in the framework of

..... programme

of the József Cziráki Doctoral School, University of Sopron

Supervisor: Dr. Zoltán Pásztory, Assoc. Professor

I recommend for acceptance (yes / no)

(signature)

The candidate reached % at the complex exam,

Sopron, 21.06.2021

.....
Chairman of the Examination Board

As assessor I recommend the dissertation for acceptance (yes/no)

First assessor (Dr.) yes/no

(signature)

Second assessor (Dr.) yes/no

(signature)

(Possible third assessor (Dr.) yes/no

(signature)

The candidate reached% in the public debate of the dissertation

Sopron,2023

.....
Chairman of the Assessor Committee

Qualification of the doctoral (PhD) degree

.....
Chairman of the University Doctoral
and Habilitation Council (UDHC)

DECLARATION

I, the undersigned Le Duong Hung Anh by signing this declaration certifying that my PhD thesis entitled “Development of new insulation material from sugarcane bagasse and examination of the insulation effect depending on temperature and humidity” was my own work; during the dissertation, I complied with the regulations of Act LXXVI of 1999 on Copyright and the rules of the doctoral dissertation prescribed by the Cziráki József Doctoral School, especially regarding references and citations.¹

Furthermore, I declare that during the preparation of the dissertation, I did not mislead my supervisor(s) or the program leader with regard to the independent research work.

By signing this declaration, I acknowledge that, if it can be proved that the dissertation is not self-made or the author of a copyright infringement is related to the dissertation, the University of Sopron is entitled to refuse the acceptance of the dissertation.

Refusing to accept a dissertation does not affect any other legal (civil law, misdemeanor law, criminal law) consequences of copyright infringement.

Sopron,2023

.....
Le Duong Hung Anh

¹ **Act LXXVI of 1999** Article 34 (1) Anyone is entitled to quote details of the work, to the extent justified by the nature and purpose of the recipient work, by designating the source and the author specified therein.

Article 36 (1) Details of publicly lectures and other similar works, as well as political speeches, may be freely used for the purpose of information to the extent justified by the purpose. For such use, the source, along with the name of the author, shall be indicated, unless this is impossible.

Acknowledgements

A dissertation is an important accomplishment and achievements of life. It might not be possible to complete the necessary research works reported in this thesis without the continuous assistance, advice, encouragement and cooperations of my supervisor Assoc. Dr. Zoltán Pásztor during my entire PhD study. I have received tremendous supports for technological knowledge sharing, materials sourcing, guidance from my colleagues.

Furthermore, the reported works in this could not be conducted without the cordial cooperations from the professors, teachers, and instructors from different laboratories of University of Sopron. I am very grateful to get supported from Dr. Zoltán Börcsök, Prof. Dr. Zsolt Kovács, Zsófia Kóczán, Dr. K. M. Faridul Hassan for their continuous help and supports. Moreover, I am also grateful and conveying special thanks to the administrative bodies of University of Sopron for their kind supports during different official functioning of my Ph.D. study in Sopron, Hungary.

Moreover, I would like to express my sincere gratitude to the “Tempus Public Foundation” for providing me financial assistance through awarding “Stipendium Hungaricum Scholarship” in 2019. I am also highly grateful acknowledging the supports from project, TKP2021-NKTA-43 which has been implemented with the support provided by the Ministry of Innovation and Technology of Hungary (successor: Ministry of Culture and Innovation of Hungary) from the National Research, Development and Innovation Fund, financed under the TKP2021-NKTA funding scheme.

Last but not least, I wish to express sincere thanks to my family and my precious friends (Doan Thi Hai Yen, Le Van Tuoi) for their great support, enthusiasm, and motivation during my difficult situations, which helped me enormously to keep patience during my Ph.D. study.

Finally, I am also grateful to the almighty creators of the Universe for providing me a beautiful life with adequate strengths, capabilities, and knowledge.

Table of Contents

DECLARATION	I
Acknowledgements.....	II
Table of Contents.....	III
List of Figures	VI
List of Tables	IX
List of Abbreviations	X
List of Notations	XII
Abstract.....	1
CHAPTER I: INTRODUCTION	3
1.1. Problem statement, Potentiality, Gaps.....	3
1.2. Energy consumption in the building sector	3
1.3. The use of thermal insulation materials.....	4
1.4. Natural fibrous insulation materials.....	8
1.5. Thermal conductivity coefficient.....	9
1.6. Factors influencing thermal conductivity of insulation materials	11
1.6.1. Temperature	11
1.6.2. Moisture content	17
1.6.3. Density	22
1.6.4. Thickness	26
1.7. Research rationale and objectives.....	28
1.8. Dissertation outline.....	28
1.9. Summary.....	29
CHAPTER II: MATERIALS AND METHODS.....	30
2.1. Materials	30
2.1.1. Coir fiber.....	30
2.1.2. Sugarcane bagasse fiber.....	31

2.2. Sample preparation	32
2.2.1. Binderless coir fiber insulation boards.....	32
2.2.2. Binderless bagasse fiber insulation boards	32
2.2.3. Biocomposites and other samples.....	33
2.3. Methods	34
2.3.1. Determination of thermal conductivity coefficient.....	34
2.3.2. Examination of temperature-dependent thermal conductivity coefficient...	35
2.3.3. Investigation of water absorption of natural fiber based insulation material	35
2.3.4. Determination of moisture-dependent thermal conductivity coefficient	37
2.3.5. Surface morphology and morphological analysis of binderless bagasse fiber insulation boards.....	38
2.3.6. Fourier transform infrared spectroscopy.....	39
2.3.7. Thermogravimetric analysis and the first derivative thermogravimetric.....	40
2.3.8. Numerical simulations of heat and moisture transfer in the multi-layered insulation materials.....	40
2.4. Summary.....	45
CHAPTER III: RESULTS AND DISCUSSION.....	47
3.1. Determination of thermal conductivity coefficient of insulation materials.....	47
3.1.1. Thermal conductivity of natural fiber reinforced polymer biocomposites ..	47
3.1.2. Thermal conductivity of cross-laminated coconut wood insulation panels.	48
3.1.3. Thermal conductivity of binderless natural fiber-based insulation boards ..	49
3.2. Examination of temperature-dependent thermal conductivity coefficient	51
3.2.1. Temperature-dependent thermal conductivity of cross-laminated coconut wood panels	51
3.2.2. Temperature-dependent thermal conductivity of binderless coir fiber insulation boards.....	53
3.2.3. Temperature-dependent thermal conductivity of binderless bagasse fiber insulation boards.....	55
3.3. Investigation of water absorption of natural fiber insulation boards.....	57

3.3.1. Water absorption of binderless coir fiber insulation boards	57
3.3.2. Water absorption of binderless bagasse fiber insulation boards	58
3.4. Examination of relative humidity dependence of thermal conductivity	60
3.4.1. Relative humidity dependence of thermal conductivity of binderless coir fiber insulation boards	60
3.4.2. Relative humidity dependence of thermal conductivity of binderless bagasse fiber insulation boards	62
3.5. Surface morphology and morphological analysis of binderless bagasse fiber insulation boards	64
3.6. Fourier transform infrared spectroscopic study	66
3.7. Thermogravimetric analysis (TGA)	67
3.8. Numerical simulations	69
3.8.1. Heat and moisture transfer through the multi-layered building insulation materials in stationary boundary conditions	70
3.8.2. Heat and moisture transfer through the multi-layered insulation materials in dynamic boundary conditions	77
3.9. Summary	82
CHAPTER IV: CONCLUSIONS AND FUTURE WORKS	84
CHAPTER V: NOVEL FINDINGS OF THE RESEARCH	86
List of publications	89
References	91

List of Figures

Figure 1.1 Classification of common insulation materials used in buildings	5
Figure 1.2 Common natural fibers used in reinforcement polymer composites.....	9
Figure 1.3 Effect of mean temperature on thermal conductivity of various building insulation materials: (a) inorganic materials; (b) organic materials; (c) advanced materials; (d) combined materials.....	16
Figure 1.4 Effect of moisture content on thermal conductivity of various building insulation materials: (a) fiberglass; (b) rockwool; (c) natural materials; (d) aerogel.....	21
Figure 1.5 Comparison of thermal conductivity regarding the density of common insulating materials.....	22
Figure 1.6 Effect of density on thermal conductivity of various building insulation materials: (a) conventional insulation materials; (b) natural fibrous insulation materials	25
Figure 2.1 Coir fiber extracted from coconut husk resources.....	30
Figure 2.2 Bagasse fiber extracted from sugarcane waste resources.....	31
Figure 2.3 (a) Tested sample; (b) Schematic of polystyrene specimen holder.....	32
Figure 2.4 Fabrication of binderless bagasse insulation materials: (a) hydrodynamically treated fiber; (b) disc shape wet mats; (c) and dry sample	33
Figure 2.5 (a) Rice straw/reed fiber reinforced PF biocomposites; (b) Coir fiber reinforced PF biocomposites; (c) Cross-laminated made with coconut wood insulation panels.	33-34
Figure 2.6 Transversal cut of a typical single heat flow meter apparatus.....	35
Figure 2.7 Photograph of water absorption process using a desiccator	37
Figure 2.8 Photograph of testing the moisture content percentage of CTCP specimen .	37
Figure 2.9 Photograph of digital microscope Targano FHD equipment	38
Figure 2.10 Photograph of SEM Hitachi S-3400N equipment	39
Figure 2.11 Photograph of FT/IR-6300 equipment	40
Figure 2.12 Photograph of TGA equipment	40
Figure 2.13 Modelled image of multi-layered insulation materials with three layers (Oriented strand board-Cellulose fiber board-Oriented strand board)	41
Figure 2.14 Ambient data for temperature and relative humidity used on the exterior side of the wall: (a) summertime; (b) wintertime	45
Figure 3.1 Thermal conductivity values of CTCP regarding the increase of mean temperature.....	51

Figure 3.2 Thermal conductivity values of CTCP regarding the increase of density at different mean temperatures	52
Figure 3.3 Thermal conductivity values of BCIB regarding the increase of mean temperatures	53
Figure 3.4 Thermal conductivity values of BCIB regarding the increase of density at different mean temperatures	55
Figure 3.5 Thermal conductivity values of BBIB regarding the increase of mean temperatures	56
Figure 3.6 Moisture content of BCIB regarding the increased relative humidity levels	58
Figure 3.7 Water absorption percentages of bagasse fiberboard regarding the absorbent time	59
Figure 3.8 Moisture content of BBIB regarding the increased relative humidity levels	60
Figure 3.9 Thermal conductivity values of BCIB regarding the increased relative humidity levels	62
Figure 3.10 Thermal conductivity values of BBIB regarding the increased relative humidity levels	63
Figure 3.11 Surface morphology of binderless bagasse insulation boards	64
Figure 3.12 SEM micrographs of bagasse particles: (a) 100 \times ; (b) 450 \times (magnification bars with scale in μm are given on the photographs)	65
Figure 3.13 SEM micrographs of binderless bagasse fiber insulation boards: (a) 450 \times , (b) 100 \times (magnification bars with scale in μm are given on the photographs)	65
Figure 3.14 FTIR spectra of binderless bagasse fiber insulation board	66
Figure 3.15 (a) Thermogravimetric analysis (TGA) curve, (b) The first derivative (DTG) of raw bagasse, bagasse particle, and long bagasse fiber	67
Figure 3.16 Thermogravimetric analysis curve and the first derivative of the TGA curve of bagasse fiber insulation board	68
Figure 3.17 Influence of mean temperature and relative humidity in the effective thermal conductivity values of the multi-layered wall structure at different thicknesses.	70
Figure 3.18 Changes in the values of the effective thermal resistance regarding the variations of mean temperature and thickness at different relative humidity levels: (a) 33%RH; (b) 57%RH; (c) 75%RH	73
Figure 3.19 Changes in the values of the effective thermal resistance regarding the variations of relative humidity and temperature at different thicknesses: (a) 50 mm; (b) 120 mm; (c) 150 mm; (d) 200 mm	74

Figure 3.20 Changes in the thermal transmittance coefficient regarding the increase in thickness of insulation layer and variations of temperature and relative humidity	75
Figure 3.21 Changes in moisture content and moisture storage capacity regarding the variations of temperature, relative humidity at the 50 mm thickness of cellulose fiberboard .	76
Figure 3.22 The effective thermal conductivity variations regarding the ambient temperature and relative humidity for 2 days in summertime and wintertime and their fitting by LSM.....	77
Figure 3.23 Variations of heat and moisture flux through: (a) internal; (b) external surfaces (b) in summertime	79
Figure 3.24 Variations of heat and moisture flux through: (a) internal; (b) external surfaces (b) in wintertime.....	79
Figure 3.25 Changes in moisture content regarding the ambient relative humidity: (a) summertime; (b) wintertime.....	81

List of Tables

Table 1.1 Classification of the commonly used insulation materials and uncertainty about their thermal conductivity	6
Table 1.2 Linear relationship between thermal conductivity and mean temperature of some commonly used insulation materials.....	14
Table 1.3 Linear relationship between thermal conductivity and moisture content of some traditional, alternative, and advanced materials	20
Table 1.4 Linear relationship between thermal conductivity and density of some natural fibrous insulation materials	24
Table 1.5 Material cost, energy saving, and energy consumption regarding insulation thickness of various thermal insulation materials	27
Table 2.1 Chemical compositions, physical properties of coir fiber	30
Table 2.2 Chemical compositions, physical properties of bagasse fiber	31
Table 2.3 Experimental design for rice straw/reed fiber reinforced PF biocomposites..	34
Table 2.4 Experimental design for long/short coir fiber reinforced PF biocomposites..	34
Table 2.5 Temperature variation between cold and hot sides.....	35
Table 2.6 Solutions used for water absorption test and respective relative humidity.....	36
Table 2.7 Boundary conditions for stationary study of the influence of temperature, relative humidity in thermal characterization of multi-layered insulators at different thicknesses of insulation layer.....	42-43
Table 3.1 Thermal conductivity and thermal resistance values of coir fiber reinforced phenolic resin biocomposites (CFPC) and rice straw/reed fiber reinforced phenolic resin biocomposites (REPC)	48
Table 3.2 Thermal conductivity and thermal resistance values of cross-laminated coconut wood insulation panel (CTCP).....	49
Table 3.3 Thermal conductivity and thermal resistance values of binderless coir fiber insulation boards (BCIB) and binderless bagasse insulation boards (BBIB).....	49
Table 3.4 TG and DTA results for raw bagasse, long bagasse chip, bagasse particle, and binderless bagasse insulation board	69
Table 3.5 Relationship between the λ_{eff} and mean temperature at different relative humidity levels as a linear function.....	72
Table 3.6 Relationship between the λ_{eff} and relative humidity at different mean temperatures as a linear function.....	72

List of Abbreviations

ASTM	American Society for Testing and Materials
BBIB	Binderless bagasse fiber insulation boards
BCIB	Binderless coir fiber insulation boards
CFPC	Coir fiber reinforced phenol formaldehyde biocomposites
CTCP	Cross-laminated coconut wood panels
DTG	Derivative thermogravimetric
ENR	Expanded nitrile rubber
EPS	Expanded polystyrene
ETCs	Effective Thermal Conductivities
EVA	Ethylene vinyl acetate
FTIR	Fourier transform infrared spectroscopy
GFPs	Gas filled panels
LWAC	Lightweight aggregate concrete
MC	Moisture content
MSC	Moisture storage capacity
OIT	Optimum insulation thickness
PCM	Phase change materials
PE	Polyethylene
PF	Phenol formaldehyde
PIR	Polyisocyanurate
PS	Polystyrene
PUR	Polyurethane
REPC	Rice straw and reed fiber reinforced phenol formaldehyde biocomposites
RH	Relative humidity
TGA	Thermogravimetric analysis
TIM	Thermal insulation material

XPS	Extruded polystyrene
VIPs	Vacuum insulation panels
WA	Water absorption

List of Notations

λ	Thermal conductivity coefficient (W/(m·K))
d	Thickness (mm)
ρ	Density (kg/m ³)
R	Thermal resistance ((m ² ·K)/W)
R ²	Coefficient of determination
U	Thermal transmittance coefficient (W/(m ² ·K))
w	Moisture content (%)

Abstract

The development of thermal insulation materials derived from natural fiber resources used in buildings and constructions has been currently solving the global energy consumption and preservation. The Ph.D. research works mainly focus on the following problems: the main factors influencing the thermal conductivity coefficient of building insulation materials; the fabrication of binderless insulation materials made of natural fiber and their thermal conductivity under the effect of temperature and relative humidity; the water absorption of natural fiber-based insulation materials regarding the variations of relative humidity; the relationship between thermal conductivity value and their influencing factors; numerical simulations of the heat and moisture transfer in multi-layered insulation materials used as an exterior wall for building envelopes.

The findings from the Ph.D. research works can be figured out as follows: firstly, the novel thermal insulation material made from sugarcane bagasse fiber produced without any binders or additives showing a potentiality for building insulation applications due to their low thermal conductivity coefficients which were found of 0.04–0.055 W/(m·K). Secondly, the thermal conductivity values of natural fiber-based insulation materials were measured at different operating temperatures range from -10 to 50 °C using the heat flow meter method. Accordingly, the thermal conductivity values of binderless coir fiber insulation boards were recorded from 0.037 to 0.066 W/(m·K) while the values found for binderless bagasse fiber insulation boards were in the range of 0.041–0.057 W/(m·K). In addition, the percentage rate of changes in the thermal conductivity values of binderless bagasse fiberboards was recorded from 16 to 20% demonstrating that these boards had a lower heat consumption according to the European-certified reference materials for thermal conductivity measurement. Thirdly, the practical examination of relative humidity dependence of thermal conductivity demonstrated the great influence of this factor on thermal performance. The thermal conductivity values of three samples of binderless coir fiber insulation boards were recorded in the range of 0.049–0.066 W/(m·K), 0.058–0.094 W/(m·K), and 0.069–0.107 W/(m·K) regarding the humidity range of 16.5–90%, whereas the values of thermal conductivity of three specimens of binderless bagasse fiber insulation boards were found of 0.044–0.049 W/(m·K), 0.046–0.052 W/(m·K), 0.058–0.069 W/(m·K) when the relative humidity increased from 33 to 96%. As a result, the obtained thermal conductivity values provided a better thermal insulated quality than that of other bio-based products and composites. On the other hand, the water absorption of natural fiber insulation materials related to relative humidity was also investigated using the

climatic chamber and the desiccator method. Results showed a similar sorption behaviour for all tested specimens in that they exhibited a typical behaviour of natural fibrous materials with a high increase of water absorption above 75% relative humidity. The water uptake of binderless bagasse insulation boards in regards to the saturated level of 75% relative humidity was carried out to examine the minimum time for the equilibrium state to be obtained. These results have contributed to the investigation of improving the hygrothermal and durability performance of natural fibrous insulation materials over time. Last but not least, numerical simulations of the effect of heat and moisture on the effective thermal conductivity of the multi-layered insulation materials and the moisture storage capacity related to the variations of ambient relative humidity also contribute to further experimental investigation in the thermal efficacy of the next generation of building insulation materials.

CHAPTER I: INTRODUCTION

1.1 Problem statement, Potentiality, Gaps

Solving the matter of traditional energy consumption and searching the proper alternative resources are vital keys to a sustainable development policy. In recent years, many different thermal insulation materials have been developed for better energy efficiency and less environment damage. These products have proved their efficiency in buildings due to their benefits such as low density, high thermal resistance, biodegradability, and low-cost effectiveness. Many previous studies have been carried out to study the thermal performance of building insulation materials from open-cell foam and inorganic fibrous materials. On the other hand, the practical investigation on polymer composites made of natural fibers derived from plant-based resources used in buildings has also shown a better thermal properties than that of those from conventional resources. Most of the experimental works notably figured out the mechanical properties, thermal conductivity coefficient and thermophysical analysis, however, the influence of some factors such as the ambient temperature effect, the variations of moisture absorption related to the relative humidity levels, or the effect of airflow velocity on the heat convective conductance has not been experimentally considered.

Some research gaps can be identified from existing literature and published studies. Firstly, there has been no detailed overview of the main factors influencing in the thermal properties of building insulation materials. Secondly, almost empirical data evaluates the coefficient of thermal conductivity of insulation materials and lessen attention to the thermal effect depending on relative humidity. Besides, most natural fibrous insulating materials are produced as polymer composites reinforced with fiber and synthetic adhesive resin. The advantages of these products are high strength, high durability, and contributing significantly to sustainable industrial applications. However, there may be safety risks when recycling composites containing formaldehyde-based adhesives that emit volatile organic compounds. Thus, binderless thermal insulation materials show more interested and being considered as one of the research objectives in the Ph.D. works.

1.2 Energy consumption in the building sector

The global energy expenditure in industrial and residential construction has become one of the most important concerns in the third decade of the 21st century. Building construction, raw material processing, and product manufacturing are the largest sources of greenhouse gas emissions. Carbon dioxide compounds are the main by-products of fossil fuel consumption, and

since buildings are among the biggest consumers of energy, they are also major contributors to global warming which is accelerating climate change and threatening the survival of millions of people, plants, and animals. According to Directive 2010/31/EU of the European Parliament and of the Council of 19 May 2010, on the energy performance of buildings, new construction will have to consume nearly zero energy and that energy will be to a very large extent from renewable resources, because the construction sector has been identified as the largest energy consumer, generating up to 1/3 of global annual greenhouse gas emissions (GHG), contributing up to 40% of global energy, and consuming of 25% of global water worldwide [1]. Global energy consumption is predicted to grow by 64% until the year 2040 from the considerable increase in residential, industrial, commercial, and urban construction due to the industrial development and growth of population, according to the Energy Information Association in 2018 [2]. As a result, environmental disasters and climate change are becoming more apparent. For instance, global warming from the greenhouse effect (45% carbon dioxide emissions in which buildings and construction industry are major contributors, [3]) is predicted to raise the Earth's average surface temperature from 1.1 °C to 6.4 °C by the end of 2100 [4,5]. The increased consumption of natural resources for lighting, refrigeration, ventilation, recycling, heating, and cooling system in commercial buildings due to the acceleration of urbanization, causes an enormous expenditure for energy. Therefore, it is necessary to use renewable resources for the purpose of energy conservation and to enhance sustainable energy strategies in the construction sector at the building level.

1.3 The use of thermal insulation materials

As the energy becomes more precious, the use of insulation materials is being enforced in buildings. Thermal insulation is a material or combination of materials that retard the rate of heat flow by conduction, convection, and radiation when properly applied [6]. Using thermal insulation products helps in reducing the dependence on heating, ventilation, and air conditioning (HVAC) systems to manage buildings comfortably. Therefore, it conserves energy and decreases the dependence on traditional resources (coal, natural gas, petroleum, and other liquids). Other advantages are profits, environmentally friendly materials, extending the periods of indoor thermal comfort, reducing noise levels, fire protection, and so on [7]. These materials will enable systems to achieve energy efficiency. They also have many applications in food cold storage, refrigeration, petroleum and liquefied natural gas pipelines [8]. Sustainable insulation products with lower embodied energy and reduced environmental emissions are also increasing in popularity and a large number of innovative types of insulation are constantly

entering the market [9]. Most of the available thermal insulation materials can be classified in four general groups including inorganic, organic, combined, and advanced materials as shown in Fig. 1.1. They are created in several forms including porous, blanket or batt form, rigid, natural form, and a reflective structure [10]. Inorganic materials (glass wool and rock wool) account for 60% of the market, whereas organic insulation materials are 27%. Conventional materials such as polyurethane (PUR), polyisocyanurate (PIR), extruded polystyrene (XPS), expanded polystyrene (EPS) are preferred in many buildings and thermal energy storage applications due to their low thermal conductivity and low cost [11].

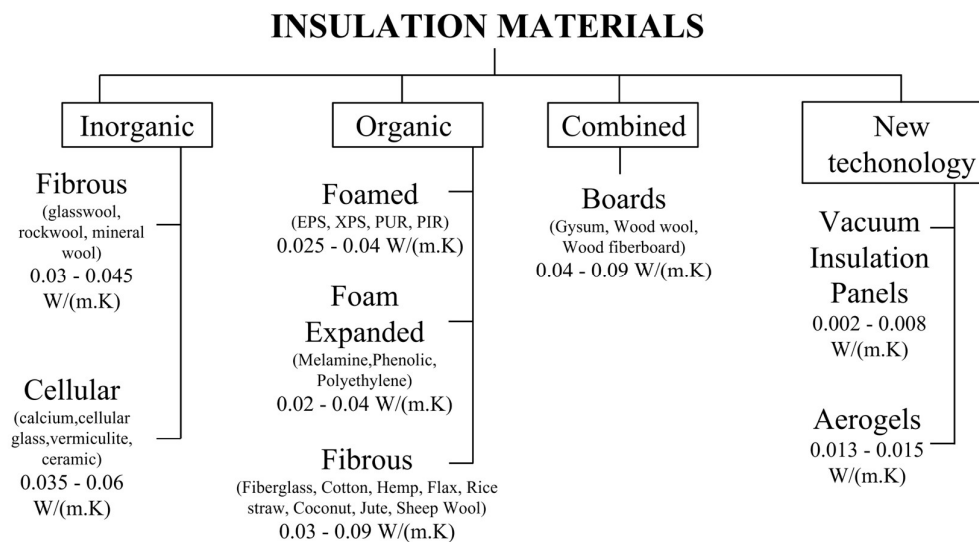

Figure 1.1 Classification of common insulation materials used in buildings.

Mineral wool includes a variety of inorganic insulation materials such as rock wool, glass wool, and slag wool. The average range of thermal conductivity for mineral wool is between 0.03 and 0.04 W/(m·K) and the typical λ -values of glass wool and rock wool are 0.03–0.046 W/(m·K) and 0.033–0.046 W/(m·K), respectively. These materials have the low thermal conductivity value, are non-flammable, and highly resistant to moisture damage. However, it can affect health problems, for example, skin and lung irritation [12]. Organic insulation materials are derived from natural resources which are currently used in buildings due to their attractiveness, renewable, high thermal resistance, environmentally friendly and required energy to manufacture is less than that of traditional materials [10]. New advanced materials such as vacuum insulation panels (VIPs), gas-filled panels (GFPs), aerogels, or phase changed material (PCM) also showed their outstanding benefits in heat retardant capacity. Among them, VIPs exhibit one of the lowest thermal conductivity values, from 0.002–0.004 W/(m·K) at the pressure of 20–300 Pa or reaching approximately 0.008–0.014 W/(m·K) because the vacuum

cannot be fully maintained permanently. This super-insulated material is created inside the panel which decreases the thickness of the thermal insulation materials, but the thermal conductivity will increase irreversible over time due to diffusion of water vapor and air through the envelope [12]. Aerogels are also considered as one of the state-of-the-art thermal insulators with the range of thermal conductivity values from 0.013 to 0.014 W/(m·K) and the density for buildings is usually 70–150 kg/m³ [13]. However, its commercial availability is very limited due to the high-cost production [14]. GFPs and PCM are the thermal insulation materials of tomorrow due to their low thermal conductivity values, 0.013 W/(m·K) and 0.004 W/(m·K), respectively. While GFPs are made of a reflective structure containing a gas insulated from the external environment by an envelope impermeable as possible, PCM stores and releases heat as the surrounding change by transforming from a solid state to liquid when heated and turning into a solid state when the ambient temperature drops [10,13,14]. Table 1.1 shows the detailed thermal properties of some common insulation materials, the data are collected and synthesized according to the literature and practical experiments.

Table 1.1 Classification of the commonly used insulation materials and uncertainty about their thermal conductivity.

Main group	Subgroup	Insulation Material	Maximum Temperature Long-term (°C)	Density (kg/m³)	Thermal conductivity (W/(m·K))	Ref.
Inorganic	Fibrous	Glass wool	500	13–100	0.03–0.045	[12,13,15]
		Rock wool	750	30–180	0.033–0.045	[7,12,13,15,16]
	Cellular	Calcium silicate	300	115–300	0.045–0.065	[16]
		Cellular glass	430	115–220	0.04–0.06	[16]
		Vermiculite	1600	70–160	0.046–0.07	[7,16,17]
		Ceramic	N.A.	120–560	0.03–0.07	[16]

Organic	Foamed	EPS	80	15–35	0.035–0.04	[7,13-16]
		XPS	75	25–45	0.03–0.04	[7,11,13-16,18]
		PUR	120	30–100	0.024–0.03	[13-16,19]
		PIR	100	30–45	0.018–0.028	[13,20]
	Foamed, expanded	Cork	110–120	110–170	0.037–0.050	[13,14,16]
		Melamine foam	N.A.	8–11	0.035	[16]
		Phenolic foam	150	40–160	0.022–0.04	[13,16]
		Polyethylene foam	105	25–45	0.033	[16]
		Fibrous	Fiberglass	350	24–112	0.033–0.04
	Sheep wool		130 – 150	25–30	0.04–0.045	[16]
	Cotton		100	20–60	0.035–0.06	[16]
	Cellulose fibers		60	30–80	0.04–0.045	[7,13,14,16]
	Jute		N.A.	35–100	0.038–0.055	[13]
	Rice straw		24	154–168	0.046–0.056	[13]
	Hemp		120	20–68	0.04–0.05	[16]
	Bagasse		200	70–350	0.046–0.055	[13,21]
Coconut	220		70–125	0.04–0.05	[13,16,21]	
Flax	N.A.	20–80	0.03–0.045	[16]		
Combined	Boards	Gypsum foam	N.A.	N.A.	0.045	[16]

	Wood wool	180	350–600	0.09	[16]
	Wood fibers	110	30–270	0.04–0.09	[16]
Advanced materials	VIPs	N.A.	150–300	0.002–0.008	[13,16]
	Aerogel	N.A.	60–80	0.013–0.014	[13,14,16,22]

There is uncertainty about the thermal conductivity values for inorganic, organic, and advanced materials which are 0.03–0.07 W/(m.K), 0.02–0.055 W/(m.K), and lower than 0.01 W/(m.K), respectively. Generally, the nominal thermal conductivity of porous materials range from 0.02 to 0.08 W/(m.K), while the thermal conductivity values of alternative insulation materials made from natural fibers vary from 0.04 to 0.06 W/(mK) according to the Table 1.1. Conventional materials such as mineral wool, foamed polystyrene are mainly used in thermal energy storage systems due to long term usage, and low cost. Natural fibers-based insulation materials derived from agricultural waste such as coconut, rice straw, bagasse, etc., currently applied in some building applications due to the environmentally friendly properties [23,24]. However, the main disadvantage is their relatively high-water absorption, resulting in high thermal conductivity. Another new development material is aerogel and VIPs with a low thermal conductivity of approximately 0.017–0.021 W/(m.K) and 0.002–0.008 W/(m.K), respectively, which exhibits excellent thermal insulation properties. In fibrous insulating materials, the fineness of the fibers and their orientation play a main role. In foam insulating materials, the thermal conductivity is determined by the fineness and distribution of the cells and particularly by the gases in those cells. Insulating materials made from wood fibers or wood wool, the density factor is critical for the insulating capacity. The range of temperature shows the minimum and maximum service temperatures based on manufacturers information. Insulating materials can react very differently to hot and cold environment and there is no uniform test method that enables a direct comparison between insulating materials [16].

1.4 Natural fibrous insulation materials

In recent days, researchers, engineers and scientists are attracted towards the use of natural fibrous materials in the manufacturing of composites because of their eco-friendly features, low cost, lightweight, abundant, renewable, better formability. Fig. 1.2 shows some

natural fibrous materials from plant-based resources commonly used in reinforcement polymer biocomposites. Natural fibers have good mechanical strength; lesser weight leads to demand for applications in engineering field. Based on the sustainability benefits, natural fibers are now being rapidly replacing synthetic fibers in composites and also finds wide applications ranging from automotive applications to textile manufacturers who are focusing utilizing natural fibers as raw materials to improve their arts and skills in their industries [25]. The growing interest in employing natural fibres as reinforcement in polymer-based composites is mostly because of the availability of natural fibers from natural resources, meeting high specific strength and modulus. However, some drawbacks were found since the natural fibers used to fabricate the composites, such as the mechanical properties were reduced because the low interfacial bonding between the natural fiber and matrix or the void has turned into a stress concentration [26]. Another disadvantage is the hydrophilicity of natural fibers resulting in the incompatible with hydrophobic polymers, thus, leading to a drop in mechanical, thermophysical properties of the composites due to the fiber swelling at the fiber matrix interphase [27].

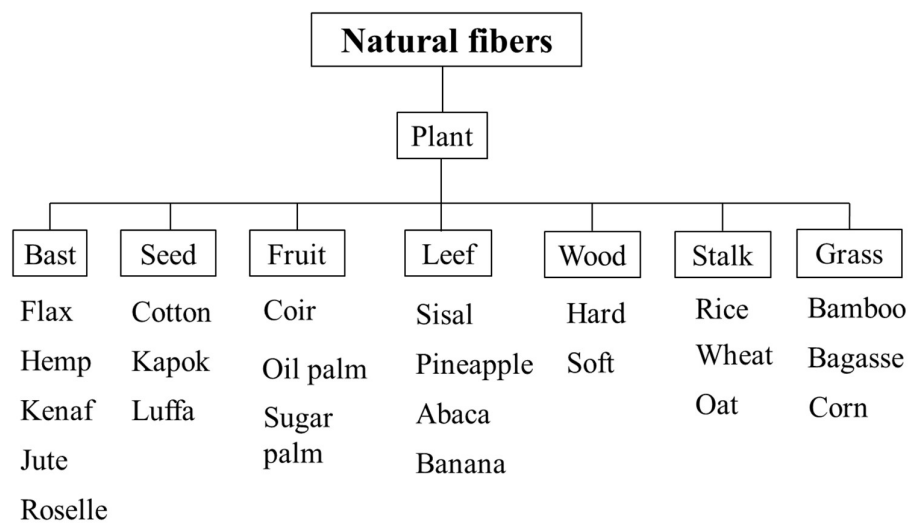

Figure 1.2 Common natural fibers used in reinforcement polymer composites.

1.5 Thermal conductivity coefficient

Insulation materials are supposed to conduct heat badly in order to prevent large heat losses. The lower the heat conduction in a material, the less heat flows through it. The thermal performance of a building envelope depends to a great extent on the thermal effectiveness of the insulation layer which is mainly determined by its thermal conductivity value (λ -value). Thermal conductivity is the time rate of steady-state heat flow through a unit area of a

homogeneous material in a direction perpendicular to its isothermal planes, induced by a unit temperature difference across the sample [28]. At the microscopic level, the apparent thermal conductivity depends on numerous factors such as cell size, diameter and arrangement of fibers or particles, transparency to thermal radiation, type and pressure of the gas, bonding materials, etc. A specific combination of these factors produces the minimum thermal conductivity. At the macroscopic level, the apparent thermal conductivity largely depends on various factors, namely mean temperature, moisture content, density, and aging. Therefore, thermal conductivity coefficient is always a primary parameter measuring in every thermal calculation.

Thermal conductivity values are usually tested which covered by standards such as EN 12664:2001 (low thermal resistance) [29], EN 12667:2001 (high thermal resistance) [30], EN 12939:2000 (thick materials) [31], ASTM C518 (heat flow meter apparatus) [32], and ASTM C177 (guarded hot plate apparatus) [33]. Nevertheless, as a result of the wide range of thermal properties of insulation materials, there is no single measurement method for all thermal conductivity measurements [34]. A good thermal insulating material can reduce the energy losses as well as minimize the emissions of the greenhouse gases from buildings. The choice of insulation material can have a great effect on energy efficiency in both cooling and heating, and on health problems. Heat transfer in thermal insulation materials is generally divided into heat conduction through the solid material, conduction through its gas molecules and radiation through its pores. Convection is mostly insignificant because of the small size of the air bubbles. To develop insulation materials in an environmentally friendly manner, it is important to know their apparent thermal conductivity [35]. According to the DIN 4108, “Thermal insulation and energy economy in buildings”, materials with a λ -value lower 0.1 W/(m·K) are generally named as thermal insulating materials. Materials with thermal conductivity values lower 0.03 W/(m·K) can be regarded as very good, whereas values from 0.03 to 0.05 W/(m·K) are only moderate, innovative nanotechnology materials have a λ -value between 0.01 and 0.015 W/(m·K) , and higher than 0.07 W/(m·K) are less effective [14,16,36,37]. The published thermal conductivity of insulation materials are usually specified by manufactures and normally investigated under standard laboratory conditions [38-41], for example, a standardized mean temperature around 23.8 °C and relative humidity of 50±10% [42]. Published thermal conductivity values evaluated at standard laboratory conditions allow a comparative evaluation of the thermal performance of different materials. However, when placed in the building envelope of each specific building, thermal insulating materials are exposed to temperature and humidity levels and their actual thermal performance differs from that predicted under standard laboratory conditions. This may result in major deviations when predicting the thermal performance of the building. Therefore,

the dependence of thermal conductivity values on the operating temperature and moisture content regarding the changes of actual ambient conditions is numerically and experimentally investigated in this study.

1.6 Factors influencing thermal conductivity of insulation materials

It is essential to examine the thermal properties of any insulation materials due to its important role affecting the heat transfer in building envelopes. Thermal properties are mainly defined by thermal conductivity, specific heat, thermal diffusivity, thermal expansion, and mass loss [43]. Among them, the thermal conductivity coefficient is the main key to measure the ability of a material to transfer or restrain heat flows through building insulation materials. At the macroscopic level, thermal conductivity largely depends on three main factors including operating temperature, moisture content, and density [23,36,41].

1.6.1. Temperature

1.6.1.1. Inorganic materials

Abdou and Budaiwi elucidated the dependence of thermal conductivity of inorganic materials under mean temperatures ranging from 4 °C to 43 °C. Their first study was conducted for rock wool and fiberglass with different densities [44]. Their results showed an increase in thermal conductivity values as a linear relation with mean temperatures. The variation was clearer with less density materials. A respective analysis of rock wool, mineral wool, and fiberglass in their next study indicated that higher operating temperatures are associated with higher λ -value, and the relationship is presented by a linear regression with temperature for most insulation materials [41]. Experiments with fiberglass and rock wool were observed in their third article in accordance with the impact of moisture content [45]. They assessed the changes in thermal conductivity with different densities not only the variation of operating temperatures ranging from 14 °C to 34 °C but also the effect of moisture content. Examination of their results continues to confirm that a higher operating temperature is always associated with higher thermal conductivity. The effective thermal conductivity of some conventional materials such as mineral wool and foam glass as a linearly increasing function at mean temperatures varying from 0 °C to 100 °C was studied with a protected heating plate device [46]. The λ -value of these insulation materials were 0.04 W/(m·K), 0.045 W/(m·K), and 0.05 W/(m·K) at a mean temperature of 10 °C. Occasionally, inorganic open-cell materials, such as fiberglass or rock wool, have been proposed the linear temperature-dependent law that displays a decreased thermal conductivity at low temperatures [47].

1.6.1.2. *Organic materials*

The change of thermal conductivity of polystyrene (PS) and polyethylene (PE) regarding mean temperatures was evaluated [41,44]. The rate of heat exchanges of PE was the most sensitive to temperature, while PS insulation was the least affected, approximately of $0.000384 \text{ (W/(m}\cdot\text{C)/}^\circ\text{C)}$ and $0.0001 \text{ (W/(m}\cdot\text{C)/}^\circ\text{C)}$, respectively. According to the statistical data of expanded polystyrene (EPS) material in determining the impact of the temperature on thermal conductivity, Gnip et al. [48] calculated the λ -value at any point in a range temperature from 0°C to 50°C by using a calculated value of thermal conductivity at 10°C . The relationships presented a slight increase with a rise of temperature demonstrating that the changes in temperature have always been ascribed to the variation of thermal conductivity. Khoukhi et al. [49] showed that higher temperatures increase thermal conductivity for three types of polystyrene materials. Their next study demonstrated a linear rise in thermal conductivity with increasing temperatures in four PE insulation specimens with densities from low to super high [50]. Testing the effect of temperature on thermal conductivity on EPS and polyurethane (PUR) materials by using the hot wire method, Song et al. [56] revealed that at the same density, the thermal conductivity coefficient increases with increasing ambient temperature.

A series of empirical observations of EPS, extruded polystyrene (XPS), PUR have shown the influence of temperature on their effective thermal conductivity [46]. The data shows the relationship between λ -value and temperatures is a linear function. An evaluation of alternative insulation materials based on sheep wool has also shown the linear increase with increasing temperature from 10°C to 40°C [51]. Koru studied the effects of temperature on thermal conductivity closed-cell thermal insulation materials using a heat flow meter according to the standards EN 12664, 12667, and ASTM C518 [36]. The results revealed that thermal conductivity increases with the rise of the range temperature between -10°C and 50°C . Based on the empirical data, the author expressed the relationships among the λ -value and the temperature as linear equation. A similar assertion also comes from the experimental investigation of Berardi et al. [18]. Zhang et al. [8] investigated the change of thermal conductivity of five PUR foams occurs at temperatures varying from -40°C to 70°C . Resembling the previous publication, Khoukhi also affirmed the incremental increases of thermal conductivity of polystyrene expanded insulation materials as the operating temperature increases when studying the combined impact of heat and moisture transfer on building energy performance [38]. Next, he continued to investigate the dynamic thermal effect of thermal conductivity at different temperatures of the same insulation materials. The experimental data showed that thermal conductivity increases linearly with temperature [52].

Besides the studies on temperature-dependent thermal conductivity of various traditional materials, there is an interesting in manufacturing natural fiber-based insulation materials with high thermal resistance. These insulators are derived from natural materials such as hemp, cotton, rice straw, or wood waste products. Manohar et al. [53] tested the apparent thermal conductivity of coconut and sugarcane fiber at a mean temperature of 24 °C with different densities, and found that the λ -value of the biodegradable materials increased with an increase in temperature. The minimum thermal conductivity of coconut and sugarcane ranged from 0.048 to 0.049 W/(m·K) and 0.046 to 0.049 W/(m·K) showing low values when compared to some conventional insulation materials. Wood-based fiberboards are also used as thermal insulation materials due to their low density, and high thermal resistance, etc. However, they are sensitive to changes in environmental conditions because of their porous internal structures. Hence, the thermal conductivity will increase by approximately 50% as the temperature goes up from -10 °C to 60 °C [54].

1.6.1.3. Combined materials

Bio-based materials can be used as an effective alternative product in buildings which reduce energy consumption and optimize the utilization of fossil fuels for the sake of sustainable development. The thermal conductivity of bio-based materials rose slightly with increasing temperature from 10 °C to 40 °C and the relationship is a linear function according to the study of Rahim et al. [55]. The same trend was demonstrated in the work of Srivaro et al. [56], with empirical tests of some rubberwood specimens which had a linear change between their thermal conductivity and the varying temperatures. The thermal conductivity of three different samples sheep wool, goat wool, and horse mane increases significantly by approximately 55% with an increase in temperature [57].

1.6.1.4. New technology materials

The combination of technical development and advanced materials produced state-of-the-art thermal building insulation including vacuum insulation panels (VIPs), aerogels, gas-filled panels (GFPs), phase changed material (PCM), and closed-cell foam [10]. Among them, VIPs exhibit the lowest thermal conductivity, approximately 2–4 mW/(m·K) with the pressure of 20–300 Pa. Its main benefit is the reduction of the required thickness of the insulation layers compared to conventional materials in buildings [58]. Fantucci et. al. [59] investigated the temperature dependence of thermal conductivity in fumed silica-based VIPs. Experimental analyses showed an increase up to 45% when the temperature increases from 2 °C to 50 °C. The next study revealed that a 53% increase in thermal conductivity of the raw VIPs from

0.0049 to 0.0075 W/(m·K), and from 0.0021 to 0.0028 W/(m·K) in fumed silica over the range of temperatures between -7.5 °C and 55 °C [60].

Aerogel is one of the potential thermal insulation materials for the future building applications due to its low density, high porosity, small average pore size, and very low thermal conductivity. They have found potential practical applications for thermal insulation systems including energy storage, construction and building [61]. Several studies have investigated the effect of temperature on thermal models of aerogel composite insulation materials [62-64]. The data of Liu et. al. [65] showed a low effective thermal conductivity of silica aerogels from 0.014 to 0.044 W/(m·K) and a nonlinear increasing correlation with increasing temperature from 280 to 1080 °K. There was the same result of three samples of silica aerogel but different densities with temperature ranges from 300 to 700 °K [64]. Thermal conductivity of aerogel blankets increased from 0.0135 to 0.0175 W/(m·K) at mean temperatures varying from -20 °C to 80 °C and the relationship was almost linear [22]. Same conclusions with increasing slightly were also shown in the study of Nosrati et. al. [66].

1.6.1.5. Influence of mean temperature in thermal conductivity values

Table 1.2 shows practical equations to illustrate the temperature-dependent thermal conductivity of different insulation materials according to data collected from published articles.

Table 1.2 Linear relationship between thermal conductivity and mean temperature of some commonly used insulation materials.

Main group	Insulation Materials	λ -T relationship	Mean temperature (°C)	Ref.
Inorganic materials	Rock wool	$1.91 \times 10^{-4}T + 0.034$	4-43	[41]
	Fiberglass	$3.01 \times 10^{-4}T + 0.028$	14-39	[51]
		$3.37 \times 10^{-4}T + 0.041$	4-43	[41]
Organic materials	EPS	$1.48 \times 10^{-4}T + 0.0356$	0-50	[48]
		$5 \times 10^{-4}T + 0.035$	10-43	[52]
		$6 \times 10^{-4}T + 0.033$	10-43	[38]
	XPS	$1.04 \times 10^{-4}T + 0.028$	10-43	[41]
	EVA	$8.46 \times 10^{-4}T + 0.038$	-10-50	[36]
	PE	$3.19 \times 10^{-4}T + 0.046$	-10-50	[36]
	PIR	$2 \times 10^{-4}T - 0.027$	7-27	[67]

	PUR	$1.71 \times 10^{-4}T + 0.027$	0–100	[68]
	Hemp	$2 \times 10^{-4}T + 0.047$	10–40	[55]
	Sheep wool	$2 \times 10^{-4}T + 0.035$	10–40	[51]
	Coconut	$2.84 \times 10^{-4}T + 0.049$	10–40	[53]
	Bagasse	$2.38 \times 10^{-4}T + 0.046$	10–40	[53]
	Rubberwood	$4 \times 10^{-4}T + 0.125$	-10–40	[56]
Combined materials	Wood wool	$3.06 \times 10^{-4}T + 0.0607$	4–43	[41]
New materials	VIPs	$4 \times 10^{-4}T + 0.0049$	-15–63	[60]
	Aerogel blanket	$5 \times 10^{-4}T + 0.0166$	-10–50	[66]

Figure 1.3 shows the relationship between thermal conductivity values of four groups of insulation materials and mean temperature increases from -10 °C to 50 °C as a linear increase [18,36,41,51,53,55,60,66]. Fibrous insulation materials such as fiberglass, hemp fibers, flax fibers, cellulose fibers, sheep wool are more affected by temperature than other insulation materials. Besides, thermal conductivity of samples having lower densities increased faster in relation to the increase in temperature. In other words, low density implies large pore volume and much more air content which causes a greater effect of operating temperature on λ -value. Additionally, the starting thermal conductivity of the open cell materials (fiberglass, rockwool) is much higher than that of the closed-cell materials (XPS, EPS, PUR) because of the high initial moisture content caused by the water penetration. Also, the thermal conductivity of aerogel and VIPs may be up to ten times lower than that of conventional insulating materials. The increase in the thermal conductivity of new advanced materials is subjected to high levels of temperature, moisture content, and aging effect. Combined insulation materials (wood wool, wood fibers) also exhibit temperature-dependence due to the high density and water absorption from surroundings.

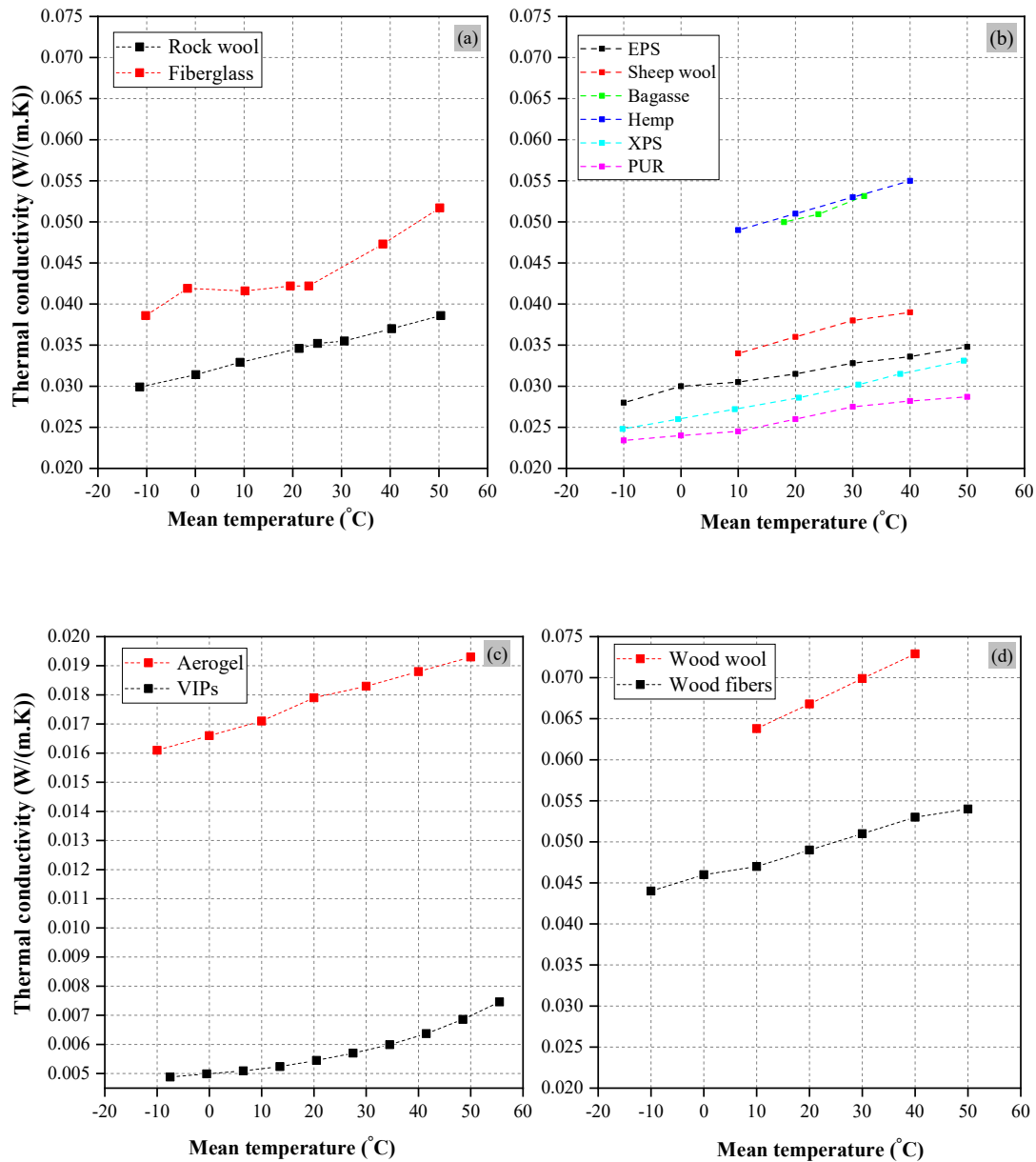

Figure 1.3 Effect of mean temperature on thermal conductivity of various building insulation materials: **(a)** inorganic materials; **(b)** organic materials; **(c)** advanced materials; **(d)** combined materials.

In general, a higher operating temperature is always associated with higher thermal conductivity for most insulation materials. As the temperature rises, the rate of heat conduction increases, then increasing the λ -value but within the limited temperature range, usually from $-10\text{ }^{\circ}\text{C}$ to $50\text{ }^{\circ}\text{C}$ and typically up to 20–30 %. This is the case with inorganic fiber insulation and some petrochemical insulating materials which show lower thermal conductivity at lower

temperatures [47]. Additionally, the relationship between thermal conductivity and temperature is almost linear due to the measurements are focused separately on the effect of these influencing factors and the experimental conditions are set up in a steady-state condition. According to the American Society for Testing and Materials (ASTM) C518 standard, thermal conductivity is only given for standardized conditions and most of the published thermal conductivity values from experimental investigations as well as from manufacturers from laboratory work [36]. However, weather conditions, exterior temperature, and moisture values vary over the course of a day. Therefore, it is important to determine the thermal conductivity of insulation materials and their dependence on temperature.

1.6.2. Moisture content

In the normal environmental conditions around buildings, all these three stages of moisture (solid, liquid, gas) can be detrimental for building materials. Excessive moisture causes the following five problems: deteriorated habitation quality, reduced thermal resistance, additional mechanical stresses, salt transport, and material decay. This phenomenon is due to both obvious as well as more inconspicuous causes: moisture intrusion into building interior due to contact with liquid water, moisture deposition on the building surface due to contact with water vapor, moisture intrusion into the building due to contact with water vapor and built-in moisture [69]. For building envelopes, insulated walls, and roofs, moisture can diminish their effective thermal properties. Additionally, moisture migrating through building envelopes can also lead to poor interior air quality as high ambient moisture levels cause microbial growth, which may seriously affect human health and be a cause of allergies and respiratory symptoms [70]. As the thermal conductivity of water is about 20 times greater than that of stationary air, water absorption is always connected with an increase in thermal conductivity [16].

1.6.2.1. Conventional materials

Some experimental investigations in building insulation materials including mineral wool, fiberglass, and polystyrene have found that an increase of thermal conductivity is always associated with rising moisture content [54,71-73]. Lakatos observed a slight increase of up to 0.2 W/(m·K) for mineral wool and fiberglass samples with varying of moisture content from 0 to 100% [73]. His previous study with extruded polystyrene (XPS) confirmed the influence of moisture content on thermal conductivity [74]. Jerman et al. [72] concluded that thermal conductivity of mineral wool rises quickly from 0.041 W/(m·K) to approximately 0.9 W/(m·K) with rising moisture content. Another investigation was concluded, in which the thermal conductivity of mineral wool increased from 0.037 to 0.055 W/(m·K) with increasing moisture

content from 0% to 10% by volume [14]. Conversely, expanded polystyrene (EPS) was only slightly affected by an increase of moisture content. Its value was $0.037 \text{ W}/(\text{m}\cdot\text{K})$ in a dry state and $0.051 \text{ W}/(\text{m}\cdot\text{K})$ in saturated conditions. Another study investigated thermal performance by cooling polystyrene (PE) insulation materials documented the rise of thermal conductivity due to the increases in moisture content [38]. An increase of thermal conductivity of mineral wool can reach a maximum of 446% with increasing moisture content of 15% [45], compared to the thermal conductivity of rock wool which can increase 312.8% with an increase in moisture content of 13.6% in the latest study of Gusyachkin et al. [71]. It can be explained by the initial moisture content. Samples with higher initial moisture content always show higher percentage change of thermal conductivity.

Most of building insulation materials are normally porous and the coefficient of thermal conductivity usually ranges from 0.02 to $0.08 \text{ W}/(\text{m}\cdot\text{K})$ [75]. Due to the high porosity, porous materials can absorb large amounts of moisture under high humidity conditions resulting in an increase in the thermal conductivity coefficient [76]. A study of Liu et al. [77] showed that thermal conductivity of foam concrete rose rapidly in the low volumetric fraction of moisture content and slowly increased with increased moisture. The authors later measured the influence of water content on the thermo-acoustic performance of building insulation materials [78]. Samples of high porosity insulation materials were treated by heat treatment through some steps before measuring with the transient plane method to assess how thermal conductivity was influenced by water content. This showed a linear increase for four types of specimens including mineral wool, melamine foam, polyurethane, and cork. When the building materials are moistened, wet insulation can increase to the maximum ratio of thermal conductivity between the dry and wet samples by 3.51 times with a maximum moisture content of 15.1% in the ambient temperature ranged from $24.9 \text{ }^\circ\text{C}$ to $38.6 \text{ }^\circ\text{C}$ after 55 days [79]. Thermal conductivity increases by approximately 200% when the moisture content reaches 10% in foam concrete. In contrast to the above conclusions, another study with wood frame insulation walls made of spruce-pine-fir concluded that there was no obvious effect on thermal conductivity since moisture content was less than 19% [80]. A study carried out by Gawin et al. [81] measured the impact of the initial moisture content on the thermal conductivity of wood-concrete and EPS-concrete materials using a heat flow meter. The results showed an increase of thermal conductivity with increasing the water content in the range of 70–85% of relative humidity. Using the same lightweight specimens but with different densities, Taoukil et al. [82] also confirmed the influence of relative humidity on thermal properties. Thermal conductivity rose rapidly with water content and was presented as an exponential equation.

1.6.2.2. *Alternative materials*

The natural insulators have shown a low value of thermal conductivity and better thermal characteristics than other conventional materials. However, a major drawback is their high wettability and absorbability due to an open structure of natural fiber, which can negatively affect the mechanical and thermal properties, therefore, it is necessary to evaluate their thermal performance regarding the changes in humidity. The moisture dependence of thermal conductivity values of different insulating materials made from hemp, jute, and flax was investigated [83]. Results showed a high increase of thermal conductivity with increasing moisture content. Data for the effect of water content in thermal conductivity of three bio-based concretes derived from hemp, jute, flax noted that there is a linear increase in λ -value as the moisture content increases and its effect is more crucial due to the increase of thermal conductivity of air and water at high temperature [55]. An experimental study on the effect of humidity on thermal conductivity of binderless board made from date palm fibers was investigated in a study of Boukhattem et al. [84]. It showed a significant increase with volumetric water content ranges from 0% to 40% and the relationship was expressed as a polynomial function. As a result, date palm fiberboard can be used as insulation materials in buildings due to its low thermal conductivity of 0.033 W/(m·K) at a dry state. The effect of moisture content due to the changes of relative humidity on thermal performance of wood-based fiberboards was evaluated. Thermal conductivity increased almost linearly with increasing moisture content [54]. The tests carried out on twenty-four soft fiberboards made from wood fibers also showed that thermal conductivity increases linearly with increasing moisture content [85]. Abdou and Budaiwi [45] investigated the thermal performance of eleven different fibrous materials at different percentages of moisture content. The results showed that higher moisture content is always associated with higher thermal conductivity for different densities. The data fit a linear relationship for almost all the specimens except for mineral wool which was expressed by a non-linear function.

1.6.2.3. *Influence of moisture content in thermal conductivity values*

The most beneficial conclusion from numerous studies mentioned above, is to elucidate the crucial impact of moisture content on thermal conductivity. As a result, thermal conductivity increases with increasing moisture content due to the presence of liquid phase. Moisture content is related to thermal conductivity in accordance with a linear law for most insulation materials. However, some experimental investigations of mineral wool and foamed insulation materials showed non-linear equations [51,57]. It could be caused by an increase in the quantity of air from the increasing the number and size of cells. Another reason could be the accuracy of

experimental measurements and variable laboratory conditions or the imperfections of the materials. Supposing that higher moisture content increases thermal conductivity, table 1.3 presents the increased linear between the λ -value and the moisture content of building insulation materials.

Table 1.3 Linear relationship between thermal conductivity and moisture content of some traditional, alternative, and advanced materials.

Main group	Insulation Materials	λ-w relationship	Moisture range (%)	Ref.
Conventional materials	Fiberglass	$4.6 \times 10^{-5}w + 0.037$	0–50	[45]
		$1.02 \times 10^{-3}w + 0.032$	0–35	[86]
	Rock wool	$10^{-5}w + 0.039$	0–50	[45]
	EPS	$7 \times 10^{-4}w + 0.035$	0–80	[74]
		$0.017w + 0.039$	0–40	[52]
	PUR	$0.0018w + 0.039$	0–80	[87]
Alternative materials	Fiberboard	$2.31 \times 10^{-4}w + 0.038$	0–14	[85]
	Bagasse	$7.2 \times 10^{-4}w + 0.088$	5–30	[88]
	Hemp	$0.298w + 0.118$	0–80	[55]
	Flax	$0.365w + 0.157$	0–80	[55]
Advanced materials	Straw	$0.239w + 0.088$	0–80	[55]
	Aerogel	$0.2w + 0.002$	0–6	[89]

Changes in thermal conductivity due to moisture variations can be explained by a shift in the division of the thermal and humidity distribution in the structure, which alters the sorption properties of the material. Fig. 1.4 illustrates the changes in thermal conductivity as the moisture content increases [45,51,66,88,90]. The thermal conductivity of natural fibrous insulating materials rises more sharply than that of foam materials for the same increased moisture content at the same temperature of 24 °C. Since the fibrous materials are naturally hygroscopic and have a porous structure, they can accumulate moisture by adsorption from the air. The ability of moisture to penetrate the internal open pore system at increased relative humidity significantly affects the temperature distribution as well as the thermal conductivity. Examination of results revealed that higher moisture content is always related to higher thermal conductivity for all densities. In addition, samples with higher density generally exhibit larger changes in λ -value at the same moisture content. Materials having similar density but

conditioned at different initial moisture content exhibit different relationships between the thermal conductivity and moisture content. The rate of change in thermal conductivity with moisture content is higher at higher initial moisture content. The lower the density of open-cell insulation materials, the higher the effect of moisture content on the thermal conductivity.

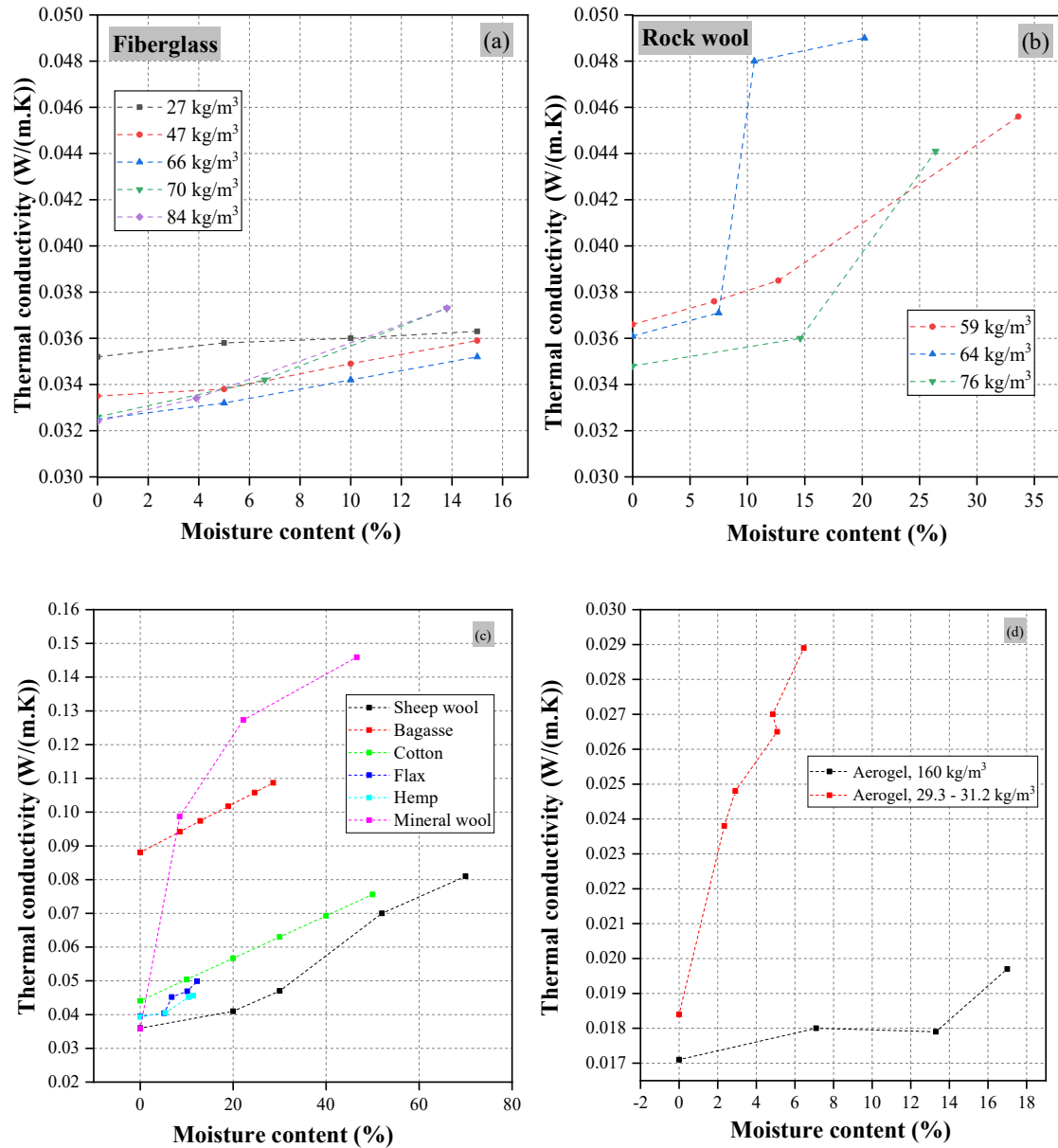

Figure 1.4 Effect of moisture content on thermal conductivity of various building insulation materials: **(a)** fiberglass; **(b)** rockwool; **(c)** natural fibrous materials; **(d)** aerogel.

1.6.3. Density

A comparison of minimum and maximum values of thermal conductivity regarding the respective minimum and maximum density of common building insulating materials collected from published studies is shown in Fig. 1.5. Materials having low thermal conductivity (below $0.05 \text{ W}/(\text{m}\cdot\text{K})$) and low density (below $100 \text{ kg}/\text{m}^3$) are placed in the first group. These are the most commonly used insulation materials in buildings today. The second group (aerogel and vacuum insulation panels (VIPs)) also has low thermal conductivity (lower than $0.015 \text{ W}/(\text{m}\cdot\text{K})$), but higher density (in the range $100\text{--}300 \text{ kg}/\text{m}^3$) than that those in the first group while the third group shows a moderate range of λ -value (between $0.04 \text{ W}/(\text{m}\cdot\text{K})$ and $0.05 \text{ W}/(\text{m}\cdot\text{K})$) at low density as the first group. The last group shows materials with the highest λ -value ($0.04\text{--}0.09 \text{ W}/(\text{m}\cdot\text{K})$) and the highest density (they are mostly polymer composites reinforced with cellulose fiber materials or wood-based products, for instance, wood wool or wood fiber).

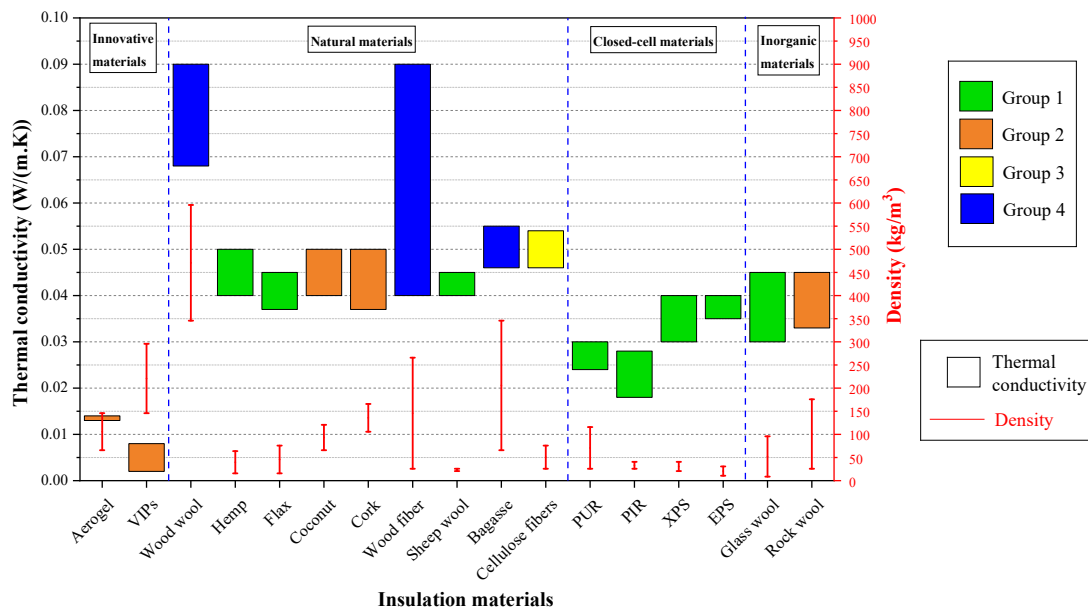

Figure 1.5 Comparison of thermal conductivity regarding the density of common insulating materials ([8,12,18,22,36,41,45,46,48,49,51,57,60,67,71,86,91-98]).

The density dependence of thermal conductivity of polystyrene, fiberglass, and mineral wool was investigated at various mean temperatures [41]. The thermal conductivity of expanded polystyrene (EPS) decreased from $0.043 \text{ W}/(\text{m}\cdot\text{K})$ and reached the minimum value of $0.032 \text{ W}/(\text{m}\cdot\text{K})$ with rising density from $14 \text{ kg}/\text{m}^3$ to $38 \text{ kg}/\text{m}^3$ at a mean temperature of $10 \text{ }^\circ\text{C}$ [48]. There was no discussion for this behavior in the article, however, it may be explained by the air

bubble sizes of porous materials in case of low density which are bigger than in the higher density foam materials. The larger bubbles provide more intense heat transfer through the material. As the density increases the air bubbles will be smaller and the frame structure become more complex. In the smaller bubble the heat transfer is lower, and additionally the more complex solid matrix system has a higher thermal resistance. By increasing the density, the solid content of the system will be higher consequently the thermal conductivity of solid parts become more dominant. These three phenomena (bubble size, complexity of the frame, amount of solid content) result an effective thermal conductivity which can reach a minimum value. Another study also found that the thermal conductivity of EPS decreases with increasing density in the range of 10 kg/m^3 and 25 kg/m^3 and the relationship was expressed by a linear function [99]. It is known that increasing density of the foam materials led to decreasing air content and size of the air inclusions. In this case, the convection of air and gas conduction are insignificant, and the heat flow is directed by the conduction of the solid particles resulting the decreased thermal conductivity. The experimental data of Khoukhi and Tahat contributed to the assumption that higher density produces lower thermal conductivity. In their first study [49], they measured thermal conductivity of three polystyrene samples with different densities at four different temperatures varying from $10 \text{ }^\circ\text{C}$ to $43 \text{ }^\circ\text{C}$ using the guarded hot plate method. The result showed that lower material density leads to higher thermal conductivity values. A respective experiment was conducted to support this hypothesis in their next studies [50,100]. When testing four heat-insulated EPS and polyurethane (PU) samples at the same temperature, the thermal conductivity first went down and then increased with an increase in density and reached its minimum value at $0.029 \text{ W/(m}\cdot\text{K)}$ and $0.026 \text{ W/(m}\cdot\text{K)}$ in the range of 17 kg/m^3 to 18 kg/m^3 and 30 kg/m^3 to 45 kg/m^3 , respectively [101]. Experimental studies of 17 different inorganic samples were investigated with changing densities from 8.9 kg/m^3 to 60 kg/m^3 [36]. It is seen that the thermal conductivity decreased with increasing density for the same types of materials. Furthermore, the thermal conductivity of specimens having lower densities increased faster than the others.

Although conventional materials are mainly used in buildings, alternative materials derived from natural sources also show the same performance requirements in heating. A study with open-cell insulation materials which are made from hemp fibers found that a reduction of thermal conductivity with an increase of density due to the condensation inside the sample [102]. Whereas the thermal conductivity of concrete-based hemp fibers increased by about 54% when the density increased by $2/3$ [103]. The test of sheep wool showed the thermal conductivity decreased by up to 21% at $40 \text{ }^\circ\text{C}$ when the bulk density increased from 20 kg/m^3

to 40 kg/m³ [51]. However, Sekino concluded the opposite trend in his experiment with cellulose fibers [104]. The λ -value increase slightly by approximately 5% with increasing density from 20 kg/m³ to 110 kg/m³. To explain this conclusion, a parameter named “the apparent thermal conductivity” was created to elucidate how density affects λ -value. The number of heat bridges formed by cellulose fibers increases with rising material density which causes increased thermal conductivity. The same result in investigating the effect of moisture on thermal conductivity at various of densities was obtained experimentally with three bio-based materials: hemp concrete, flax concrete, and rape straw concrete. It is showed that dry thermal conductivity was expressed as a linearly increasing function of the dry density [55]. Another study of G. Balčiūnas et al. [105] demonstrated that the thermal conductivity of hemp shives composites depends on 97% of density and the relationship shown as a multiple regression equation. Also, this specimen had low thermal conductivity from 0.055 W/(m·K) to 0.076 W/(m·K) within the range of 210 kg/m³ to 410 kg/m³ due to the low density of the spropel binder additive. Among the different types of natural fibers, coconut fiber has been used as the potential lightweight material when using as reinforcement in a composite. A study of three types of coconut samples exhibited that thermal conductivity decreased from 0.052 W/(m·K) to 0.024 W/(m·K) with an increase in density from 30 kg/m³ to 120 kg/m³ [106]. Table 1.4 shows the increased linear of some fibrous insulation materials.

Table 1.4 Linear relationship between thermal conductivity and density of some natural fibrous insulation materials.

Insulation materials	λ-ρ relationship	Density (kg/m ³)	Ref.
Cellulose fiber	$1.73 \times 10^{-4} \rho + 0.0262$	20–110	[104]
Hemp concrete	$2.37 \times 10^{-4} \rho + 0.0196$	200–600	[55]
Flax concrete	$2.48 \times 10^{-4} \rho + 0.0192$	200–600	[55]
Straw concrete	$1.61 \times 10^{-4} \rho + 0.0221$	200–600	[55]
Straw bale	$1.90 \times 10^{-4} \rho + 0.0450$	50–130	[107]

A model consisting of aerogel, calcium silicate and xonotlite-aerogel composite insulation materials was built to determine the effect of their densities on their thermal conductivity [64]. In the range of optimal density from 110 kg/m³ to 160 kg/m³, the thermal conductivity of aerogel reached the minimum value of approximately 0.016 W/(m·K) and the density of calcium silicate was the key factor to affect the λ -value of the aerogel composite.

Moreover, with an increase of the density of the silicate up to 250 kg/m^3 , the thermal conductivity of the aerogel composite increased by 200%. The relation between thermal conductivity and density is nonlinear, the limiting low value of thermal conductivity is $0.012 \text{ W/(m}\cdot\text{K)}$ which is denoted for density as 150 kg/m^3 [108]. Investigation of vacuum insulation panels (VIPs) with wood fiber core materials noted that their thermal conductivity increases slowly with increasing density less than 240 kg/m^3 and rapidly increases since the density reaches 260 kg/m^3 [109].

Influence of density in thermal conductivity values

Fig. 1.6 illustrates the variation in thermal conductivity at mean temperature of $24 \text{ }^\circ\text{C}$ with density of conventional insulation materials (Figure 1.6a) and natural fibrous insulating materials (Figure 1.6b). Generally, the most favourable densities range for practical investigation falls between 20 kg/m^3 and 140 kg/m^3 .

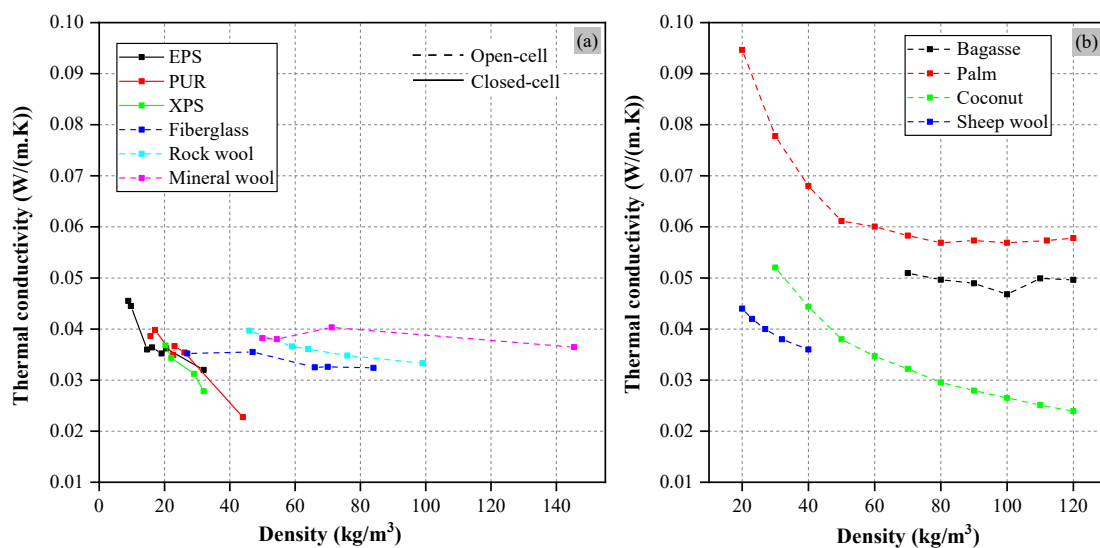

Figure 1.6 Effect of density on thermal conductivity of various building insulation materials: **(a)** conventional insulation materials; **(b)** natural fibrous insulation materials.

For closed-cell materials, it can be stated that high density shows low thermal conductivity. At densities range from 20 kg/m^3 to 40 kg/m^3 , the thermal conductivity of expanded polystyrene (EPS), extruded polystyrene (XPS), and polyurethane (PUR) showed the trend that decreased as density increased as shown in Fig. 1.6a [36,41,45]. It is because higher density means smaller pores and less air volume, resulting in the heat flow through the materials is mainly governed by the thermal conduction of the solid particles, while the effect of the heat transfer by convection and radiation becomes insignificant. This causes a decrease in λ -value.

Besides, the variation in thermal conductivity values of EPS and PUR can be explained by the difference of microstructure, porosity, and pore dimensions of the foam insulation materials. The thermal conductivity of open-cell materials also shows the linear decrease as the density increases in the range of 40 kg/m^3 and 140 kg/m^3 and the changes in thermal conductivity values of mineral wool and fiberglass can be explained by the air bubbles present in the porous structures. Besides, the effect of density on thermal conductivity of open-cell materials is generally lesser than that of closed-cell materials. It is because the diffusion of gas in the foam materials; the higher the apparent density the lower the proportional of gas filling up the cells, and thus the lower the impact of other influencing factors like mean temperature, moisture content, or aging. On the other hand, fibrous materials such as bagasse, palm, coconut fibers showed the variation in which the thermal conductivity decreased to a minimum and then increased as density increased from the minimum possible value upwards [51,96,106]. This behavior shows the same reaction with the result in article [48], therefore, it can be explained by three phenomenon include bubble size, complexity of the frame, and the amount of solid particles. Besides, the non-linear decrease may come from the reduction of wettability and absorbability due to a reduction of the voids in open structure of the natural fiber since increased density. The decreased thermal conductivity may be explained by the heat conduction mechanism, if fibrous materials are high density, thermal conductance through the solid particles is more important than both radiation and convection. In this conduction, the thermal conductivity is decreased while the density increases. Additionally, it is also shown that an increase in solid fiber density reflected an increase in thermal conductivity values of the fibrous batt after reaching the minimum value and it is consistent with loose fill materials having higher thermal conductivity than closed-cell insulation materials.

1.6.4. Thickness

It is a common understanding that the thicker the insulation, the lower the heat transfer through it [110]. However, thermal conductivity is not dependent on the thickness of insulation, which instead affects its thermal resistance value (R-value) [111]. Lakatos et al. investigated the dependence of the thermal conductivity on the thickness of the expanded materials [99]. They proved that thermal conductivity does not depend on the thickness of the specimens, contrary to the R-value. The thermal resistance increased regarding to the calculated data from the measurement. In another study with sheep wool, the thermal resistance showed an increase with increasing thickness of samples from 40–80 mm at varying of mean temperature [51]. Mahlia et. al. evaluated the correlation between the thickness and the thermal resistance of fiberglass, urethane, expanded polystyrene (EPS) through the thermal conductivity values

[112]. The main objective of the research was to point out the optimum thickness to reduce the heat flow rate through building wall. The impact of thickness on the thermal transmittance of EPS, glass wool, and wood cement board for the external wall structure has been investigated [113]. For construction, the thermal transmittance and its thermal resistance have a reciprocal relationship; the lower the thermal transmittance, the higher the thermal resistance; and consequently, the higher thermal insulation of wall structure. The results indicated that the thermal resistance increased for all three types of insulation material as the thickness increased up to 0.2 m. In addition, there is a critical thickness for the thermal insulation of the external wall. One of the popular ways to improve thermal performance is to use an enclosed air layer in exterior building envelopes since the air has low thermal conductivity. Zhang et al. found that the thermal resistance increased by 14.77% when the thickness of the air layer increased from 10 to 20 mm, but the effect was limited when the thickness exceeded 20 mm [114]. Insulation thickness with material costs, energy saving, and energy consumption was investigated in some studies whose data is shown in Table 1.5.

Table 1.5 Material cost, energy saving, and energy consumption regarding insulation thickness of various thermal insulation materials.

Insulation Materials	Thermal conductivity (W/(m·K))	Thickness (mm)	Material cost (\$/m³)	Energy Saving (\$/m)	Energy Consumption (MJ/f.u. kg)	Ref.
Rock wool	0.04	50	95	6.2	53.09	[111,115, 116]
Glass wool	0.038	50	155	5.6	229.02	[11,116]
Fiberglass	0.05	50	350	25.6	-	[116,117]
XPS	0.035	50	224	27.2	127.31	[36,111,1 16]
EPS	0.035	50	155	28.4	80.8–127	[11,20,36 ,116]
PUR	0.022	50	156	-	99.63	[11,116,1 17]
PIR	0.025	25	152	-	69.8	[11,116]
VIPs	0.008	5	247	-	149–226	[11,116]
Aerogels	0.015	20	547	-	53.9	[11,116]

1.7 Research rationale and objectives

The advent of natural fibrous insulation materials derived from plant-based resources has proved a potentiality for the new thermal insulation materials used in buildings, in order to meet the demands of energy preservation worldwide. The comprehensive review has been conducted to figure out the factors influencing the thermal conductivity of insulation materials and their possible relationships. Understanding the quantitative relationship between the effective thermal conductivity and actual influencing factors is essential in determining the thermal performance and energy consumption in buildings. On the other hand, lignocellulose insulation materials can be manufactured without using synthetic resin resulting in a reduction in cost, the hazardous effects on human health, and the environmental burden imposed by disposal or recycling of the bio-based fiberboards [118].

In the light of the comprehensive review, the following research objectives were proposed:

- Development of binderless thermal insulation materials from natural fiber resources.
- Determination of the thermal conductivity coefficient of natural fiber insulation materials and their values regarding the variations of temperature and relative humidity.
- Experimental examination of the water absorption regarding the variations of relative humidity.
- Experimental examination of the influence of temperature and humidity in the thermal conductivity of binderless insulation materials.
- Characterization of natural fiber insulation materials using advanced analytic techniques (SEM, FTIR, TGA).
- Numerical simulation of the heat and moisture transfer in the multi-layered insulation materials used as an exterior wall for building envelope.

1.8 Dissertation outline

This dissertation has been structured into four chapters as follows:

Chapter I – outlines the problem statement and the research outcomes. It presents the comprehensive review on the factors influencing the coefficient of thermal conductivity of insulation materials. It also discusses the relationship between the thermal conductivity values and mean temperature, moisture content, density. Overall, the chapter provides the following insights for current and future research to examine the dependence of thermodynamic parameters on unavoidable influencing factors.

Chapter II – works with the materials, sample preparation, instrumentation and empirical methods employed for thermal conductivity measurement, the water absorption test, and the changes in thermal conductivity values under influence of temperature and relative humidity have been discussed. Other practical analyses are also presented.

Chapter III – presents and discusses the thermal conductivity of samples made from natural fiber including coconut fiber, rice straw fiber, energy reed fiber, and sugarcane bagasse fiber. The empirical results can be used for comparison or reference with other commonly used insulation materials in buildings and constructions. This chapter also examines the dependence of thermal conductivity of insulation fiberboard on temperature and humidity. Their relationship is also explored using the linear regression technique. The numerical simulations of the heat and moisture transfer in the multi-layered insulation materials have been investigated to evaluate the potentiality of the next generation thermal insulation materials used in building envelopes.

Chapter IV – presents the conclusions of the research work and recommendations for future research.

1.9 Summary

This chapter presents a comprehensive review for a better fundamental understanding of different building insulation materials and their thermal conductivity coefficient. The main research questions are: the factors influencing thermal conductivity coefficient of insulation materials used in building envelopes; the possible relationship between mean temperature, moisture content, density and thermal conductivity. This chapter also reports the λ -value of some common traditional and new technology insulating materials used in building and construction.

Lignocellulose is an attractive material owing to its huge abundance, easy availability, low-cost, biocompatibility, non-toxicity, while cellulose-based insulation materials are promising for sustainable building applications due to their eco-friendliness, lightweight, durability, high strength, and good heat retardant capacity. The development of natural fiber-based insulation materials, their thermal characteristics, and the relationship between thermal conductivity coefficient of insulation materials and temperature, humidity have stated general research for the Ph.D. works.

The research objectives have been formulated bearing in mind the needs of the current use of natural resources in the context of reducing the energy consumption from traditional sources and enhancing the energy efficiency in construction sector at a building level.

CHAPTER II: MATERIALS AND METHODS

2.1 Materials

2.1.1. Coir fiber

Coir fiber were extracted from raw coconut husk (*Cocos nucifera* L.) which were collected in Vietnam. The fibers were washed with water in order to eliminate the pollutant particles until the water is clean, they are then dried: firstly, being sun dried for two days and then further oven dried at 70 °C in 24 hours (Fig. 2.1). Chemical compositions of coir fiber are shown in Table 2.1.



Figure 2.1 Coir fiber extracted from coconut husk resources.

Table 2.1 Chemical compositions, physical properties of coir fiber.

Compositions and Properties	Unit	Value	Ref.
Cellulose	%	36–43	
Hemicellulose	%	20	
Lignin	%	41–45	[106,119-
Density	g/cm ³	1.25–1.5	121]
Tensile strength	MPa	105–175	
Young's modulus	GPa	4–6	
Moisture content	%	13.68	[122]

2.1.2. *Sugarcane bagasse fiber*



Figure 2.2 Bagasse fiber extracted from sugarcane waste resources.

Bagasse fiber is bioproduct of sugar cane plant (*Saccharum officinarum* L.) which is basically the residual cane stalk left after crushing and squeezing to extract their juice. The sugarcane waste was oven-dried for 24 hours at 70 °C to remove the leftover juice, then were defibrated using a grinding machine to extract the bagasse fiber. The collected materials were notably long stems and particles as seen in Fig. 2.2. To achieve the homogeneous finest fiber, all the defibrated materials were sieved using a Sieve analyzer having different dimensions from 0.1 to 2 mm. Chemical compositions, physical properties are presented in Table 2.2.

Table 2.2 Chemical compositions, physical properties of bagasse fiber.

Compositions and Properties	Unit	Value	Ref.
Cellulose	%	40–50	
Hemicellulose	%	25–30	[123,124]
Lignin	%	20–25	
Ash	%	2.4	[123]
Density	g/cm ³	1.25	[125]
Tensile strength	MPa	20–50	[126]
Young's modulus	GPa	2.7	
Moisture content	%	6.95	[127]

2.2 Sample preparation

2.2.1 Binderless coir fiber insulation boards

The binderless coir fiber insulation boards (BCIB) were produced in a Laboratory of Department of Timber Architecture at the University of Sopron. They were manufactured by placing the same number of mats in the forming box size of 250 mm × 250 mm and hand-formed into homogeneous single layer. After forming, the mats were pressed to compact the materials into the expected thicknesses of 30, 40, and 50 mm. The tested samples were surrounded by the polystyrene specimen holder to ensure the one-dimensional heat flow over the metered area (see Fig. 2.3).

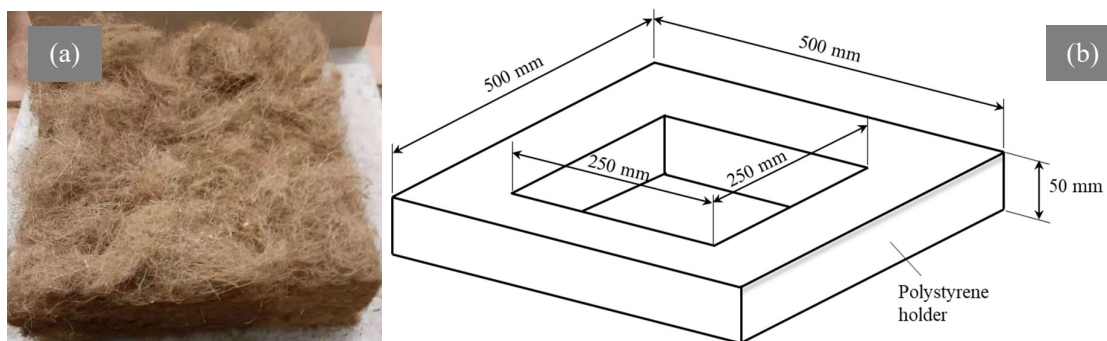

Figure 2.3 (a) Tested sample; (b) Schematic of polystyrene specimen holder.

2.2.2 Binderless bagasse fiber insulation boards

For binderless bagasse insulation fiberboard, the wet-forming process was applied for the low-density fiberboard without using binders. It is because the lignocellulose boards can be manufactured by the activation of the element's self-bonding feature due to the hydrogen bond formation and adhesive behaviour of lignin and cellulose which occur during heating and drying process [128]. After the extraction process, the bagasse fibers were soaked in tap water and defibrated again by adjusting the grain and grinders distance. The distance of the discs was changed from 5 to 0.1 mm to achieve a consistency of 3-9%. The mixture was then poured into a round-shaped mold with diameter of 50 cm and the dewatering was done by gravitational force for overnight, then the disc shape mats (Fig. 2.4b) was placed into the oven to dry at 70 °C until reaching a constant weight. All the dry specimens (Fig. 2.4c) were sanded flatly and left in the ambient laboratory condition until further processing. The tested specimens for thermal conductivity measurement were cut from the dry samples into the dimension of 250×250×20 mm³, 250×250×25 mm³, and 250×250×30 mm³ for the thermal conductivity measurement.

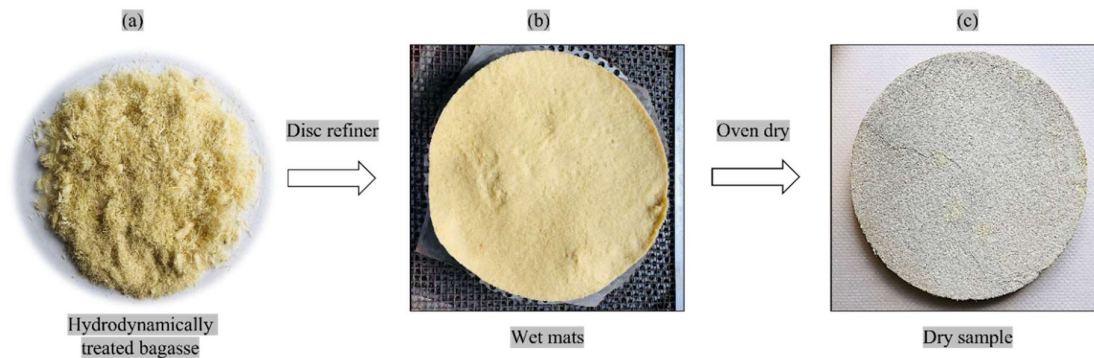

Figure 2.4 Fabrication of binderless bagasse insulation materials: **(a)** hydrodynamically treated fiber; **(b)** disc shape wet mats; **(c)** dry sample.

2.2.3 Biocomposites and other samples

Some natural fiber-based polymer biocomposites used for thermal conductivity measurement were fabricated from the colleagues at Faculty of Wood Engineering and Creative Industry (University of Sopron) including three samples of rice straw and reed fiber reinforced phenol formaldehyde (PF) biocomposites (REPC) with the dimension of $400 \times 400 \times 12 \text{ mm}^3$ (Fig. 2.5a), three samples of coir fiber reinforced phenol formaldehyde polymeric biocomposites (CFPC) with the dimension of $400 \times 400 \times 8 \text{ mm}^3$ (Fig. 2.5b). These biocomposites were produced using the hot-pressing technology and the experimental design for each biocomposites are shown in Table 2.3 and Table 2.4. Besides, four specimens of cross-laminated made with coconut wood panels (CTCP) with the dimension of $200 \times 200 \times 60 \text{ mm}^3$ were supported from Center of Excellence in Wood and Biomaterials, Walailak University, Thailand (Fig. 2.5c). Each specimen was formed by binding three panels with the dimensions of $200 \times 200 \times 20 \text{ mm}^3$ using the glue melamine formaldehyde spreading on the surface to layup a CTCP specimen.

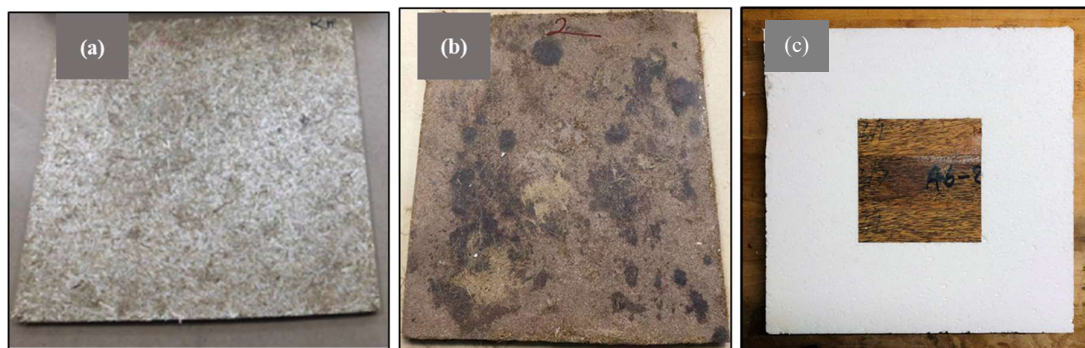

Figure 2.5 (a) Rice straw and energy reed fiber reinforced PF biocomposites (REPC) ([129]); **(b)** Coir fiber reinforced PF biocomposites (CFPC) ([130]); **(c)** Cross-laminated made with coconut wood insulation panels (CTCP) ([131]).

Table 2.3 Experimental design for rice straw and reed fiber reinforced PF biocomposites, [129].

Composite	Rice straw (%)	Energy reed (%)	PF (%)	Density (kg/m³)
REPC-a	54	36	10	725.00
REPC-b	36	54	10	742.79
REPC-c	0	90	10	764.49

Table 2.4 Experimental design for long and short coir fiber reinforced PF biocomposites, [130].

Composite	Short coir fiber (%)	Long coir fiber (%)	PF (%)	Density (kg/m³)
CFPC-a	80	10	10	453.30
CFPC-b	80	10	10	648.03
CFPC-c	80	10	10	894.48

2.3 Methods

2.3.1 Determination of thermal conductivity coefficient

The coefficient of thermal conductivity was measured in accordance with standard test for steady-state heat transfer using heat flow meter (HFM) method according to standards EN 12667:2002 – Thermal performance of building materials and product [132] and ISO 8301:1991/Amd 1:2002 Thermal insulation – Determination of steady-state thermal resistance and related properties — Heat flow meter apparatus — Amendment 1 [40]. Heat flux was determined with sensors (size = 120 mm × 120 mm, an accuracy of 0.1 W/m²) which were inserted at the middle of the heating plate. For any mean temperature tested, the temperature difference between the cold and hot sides of the specimen was set to be constant at 10 °C. Thermal conductivity (noted as λ) was calculated using Eq. (2.1)

$$\text{Thermal conductivity (W/(m}\cdot\text{K)), } \lambda = -\frac{q}{dT/dx} \quad (2.1)$$

where q is the heat flow rate (W/m) and dT/dx is temperature gradient (K/m).

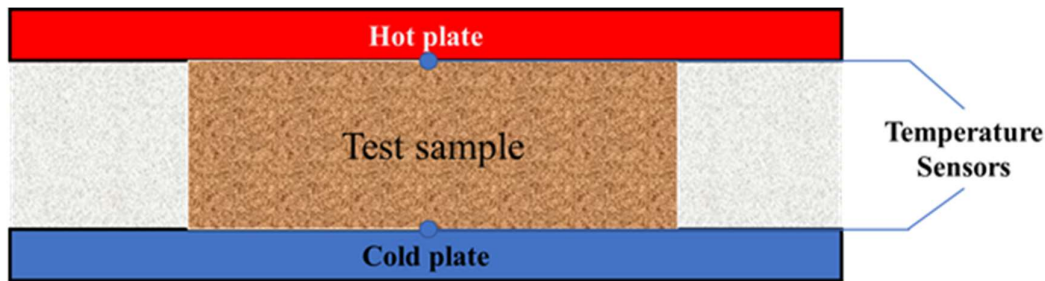

Figure 2.6 Transversal cut of a typical single heat flow meter apparatus.

2.3.2 Examination of temperature-dependent thermal conductivity coefficient

Based on the actual ambient temperature varies at different regions and throughout the days and seasons, the influence of temperature in thermal conductivity was examined by measuring λ -value at 11 different mean temperatures incremented by 5 °C from -10 °C to 50 °C according to European certified reference materials for lambda measurement with the temperature difference was remained at 10 °C, as shown in Table 2.5. The thermal conductivity values were conducted using the heat flow meter method.

Table 2.5 Temperature variation between cold and hot sides.

Mean temperature (°C)	-5	0	5	10	15	20	25	30	35	40	45
Cold plate (°C)	-10	-5	0	5	10	15	20	25	30	35	40
Hot plate (°C)	0	5	10	15	20	25	30	35	40	45	50
Temperature difference (°C)	10 in all cases										

2.3.3 Investigation of water absorption of natural fiber based insulation material

The water absorption of binderless fiberboard was conducted by measuring the total mass change of a sample that is exposed to a specified environment using the climatic chamber and the desiccator according to according to the ISO 12574:2021(en) standard – Hygrothermal performance of building materials and products – Determination of hygroscopic sorption properties.

Water absorption of binderless coir fiberboard

The binderless coir fiberboard specimens were first dried to record the dry weight and then put in the climatic chamber to expose to humid air with the relative humidity (RH) was set at five levels (15%, 40%, 60%, 80%, 95%). The weight of the samples was constantly measured

until reaching the constant value in the equilibrium state and the moisture content was calculated by using the following equation:

$$\text{Water absorption (\%), } WA = \frac{m(t) - m_d}{m_d} \times 100\% \quad (2.2)$$

where $m(t)$ is the weight as a function of time (g), m_d is the dry weight (g).

Water absorption of binderless bagasse fiberboard

The binderless bagasse fiberboard samples were conditioned in different humidity levels in a sealed desiccator containing saturated salt solutions. Table 2.6 presents the relative humidity levels selected for measuring the absorption at room temperature and the respectively used salt solutions. The sorption test was implemented with the saturated solutions prepared by mixing salt and distilled water. The solution was poured into a glass plate, then this plate was put to the bottom of desiccator to maintain the expected relative humidity. A ceramic mesh was placed at 5cm above the plate to hold the samples (see Fig. 2.7). Before placing the samples in the desiccator, they were constantly dried in an oven at 70 °C to record the initial weight (m_d). The vacuum oil was used for sealing to prevent the air leakage. Finally, the entire installation was stored in a room condition. The weight of samples was periodically measured until they reached the equilibrium state (the state that the change of mass between three consecutive weighing became less than 0.1% of the total weight). The water absorption was calculated using following Eq. (2.2).

Table 2.6 Solutions used for water absorption test and respective relative humidity.

Salt	Chemical formula	Density (g/ml)	Saturated RH (%)	Solubility at 20 °C (g/g)
Magnesium chloride	MgCl ₂ .6H ₂ O	1.569	33	54.57
Magnesium nitrate	Mg(NO ₃) ₂ .6H ₂ O	1.464	53	70.07
Sodium chloride	NaCl	2.165	75	36.00
Potassium nitrate	KNO ₃	2.11	96	38.30



Figure 2.7 Photograph of water absorption test using a desiccator.

The moisture percentages present in the cross-laminated panels made of coconut wood (CTCP) was measured using the Hydromette M4050 device as shown in Fig. 2.8. It is a multifunctional measuring meter with data storage for wood moisture, structural moisture, humidity and temperature.



Figure 2.8 Photograph of testing the moisture content percentage of CTCP specimen.

2.3.4 Determination of moisture-dependent thermal conductivity coefficient

As natural fibrous materials are naturally hygroscopic and have a porous structure, they can accumulate moisture by adsorption from the air. The capabilities of penetrating moisture into the internal open pore system at increased relative humidity significantly affect the temperature distribution and thermal conductivity as well.

For the moisture-dependent thermal conductivity of binderless coir fiber insulation boards, three samples with the dimension of $250 \times 250 \times 30 \text{ mm}^3$, $250 \times 250 \times 40 \text{ mm}^3$, and $250 \times 250 \times 50 \text{ mm}^3$ were placed into the climatic chamber to expose to five different humidity levels (15%, 40%, 60%, 80%, and 90%) until reaching the equilibrium state. Their thermal conductivity values were measured at a mean temperature of $20 \text{ }^\circ\text{C}$ using the heat flow method.

For the moisture-dependent thermal conductivity of binderless bagasse fiber insulation boards, three samples with the dimension of $200 \times 200 \times 20 \text{ mm}^3$, $200 \times 200 \times 25 \text{ mm}^3$, and $200 \times 200 \times 30 \text{ mm}^3$ were tested. The samples were put in the desiccator which was pre-prepared with the respective solutions (four solutions were used to generate the humidity levels of 33%, 57%, 75%, and 96%). The thermal conductivity values regarding the different humidity levels were conducted at a mean temperature of $20 \text{ }^\circ\text{C}$ after reaching the saturated state in the desiccator using the heat flow meter method.

2.3.5 *Surface morphology and morphological analysis of binderless bagasse fiber insulation boards*

The surface morphology of binderless bagasse fiber insulation boards was analyzed using the digital microscope model Targano FHD Prestige (Fig. 2.9) and the morphological examination was conducted through the scanning electron microscopy (SEM) equipment (Hitachi S-3400N, Tokyo, Japan) at two times of magnifications (100 and 450) and at 20kV for the bagasse particles, and the tested binderless bagasse samples (Fig. 2.10). These techniques provide finer details on the surface morphology, composition, crystallography, and topography of the samples.

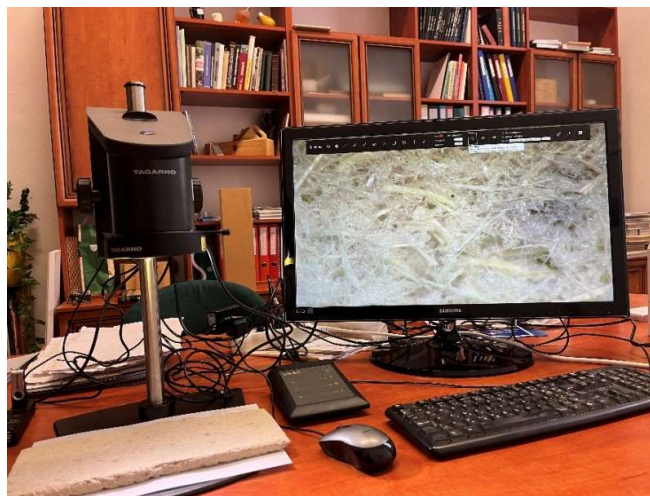

Figure 2.9 Photograph of digital microscope Targano FHD equipment.



Figure 2.10 Photograph of SEM Hitachi S-3400N equipment.

2.3.6 *Fourier transform infrared spectroscopy*

Fourier transform infrared spectroscopy (FTIR) is a spectroscopic technique based on the absorption of infrared radiations by molecules to detect the functional groups and bonding patterns in the specimen. A change in the dipole moment of IR active molecules leads to stretching or bending molecular vibrations [133]. In this research work, FTIR was used for investigating the structural composition of the binderless bagasse fiberboard through the transmission mode. The FTIR spectra were collected using a Jasco FT/IR-6300 (Fig. 2.11). Full scan spectra were recorded in the mid-IR region of $4000\text{--}400\text{ cm}^{-1}$ at ambient conditions. The spectra were then analyzed using OriginPro 2018 software.



Figure 2.11 Photograph of FT/IR-6300 equipment.

2.3.7 *Thermogravimetric analysis and the first derivative thermogravimetric*

The thermogravimetric analysis (TGA) and the first derivative thermogravimetric (DTG) were obtained by using Labsys evo STA 1150 (Setaram, France) according to standard ASTM D3850 (Fig. 2.12). About 17–21 mg of fibers and specimens was heated from ambient temperature to 800 °C at 20 °C/min under nitrogen atmosphere (50 mL/min flowrate).



Figure 2.12 Photograph of TGA equipment.

2.3.8 *Numerical simulations of heat and moisture transfer in the multi-layered insulation materials*

Study I – Heat and moisture transfer in the multi-layered insulation materials in the static boundary conditions

Fig. 2.13 shows the geometrical model of a multi-layered insulated wall using for building envelopes. The wall consists of three layers in order oriented-strand board, cellulose fiber board, and oriented-strand board (OSB-CFB-OSB). As cellulose fiber-based board is used as an insulation layer, it is essential to investigate their thermal performance due to the sensitivity of natural fibrous insulation materials to temperature and humidity when the wall is exposed to the actual environmental conditions.

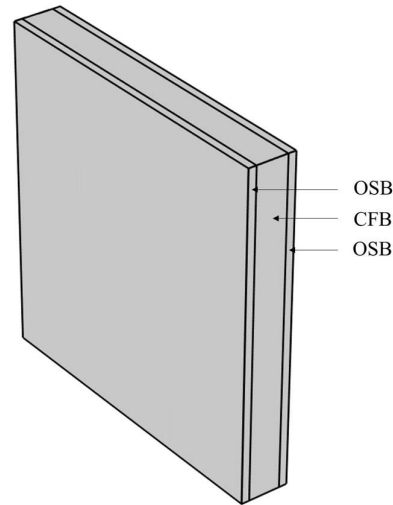

Figure 2.13 Modelled image of multi-layered insulation materials with three layers (Oriented strand board-Cellulose fiber board-Oriented strand board).

The heat and moisture transfer in the multi-layered insulation materials used as an exterior wall for building envelopes are coupled to each other. The conduction of heat causes evaporation or condensation of water, and similarly, the moisture also causes changes by latent heat when the phase change occurs. Some assumptions are made in order to eliminate some unnecessary factors and make the simulation more specific:

- The wall is a continuous and homogeneous medium, and isotropic. The wall will not undergo compression deformation during heat and moisture transfer, thus, the porosity of the wall does not change.
- The effect of radiation and capillary hysteresis during moisture absorption and desorption on heat transfer is not considered.
- The thermal properties of the wall matrix such as density and heat capacity do not change when temperature and moisture content change.
- There is no dissolution of chemical substances during the process of moisture transfer.
- Since the thickness of the wall is smaller than the height and weight of the wall (50–200 mm thickness compared to 500×500 mm), the model of the heat and moisture transfer is simplified to the one-dimensional problem.

Based on the above assumptions, the governing equations of the dynamic modeling of heat transfer and moisture transport of the wall are defined in the Norm EN 15026:2007 [134]:

$$(\rho C_p)_{eff} \frac{\partial T}{\partial t} - \nabla \cdot (\lambda_{eff} \nabla T + L_v \delta_p \nabla (\phi P_{sat})) = Q \quad (2.3)$$

$$\zeta \frac{\partial \phi}{\partial t} + \nabla \cdot (\xi D_w \nabla \phi + \delta_p \nabla (\phi p_{sat})) = G \quad (2.4)$$

where:

Q is the heat source ($\text{W}/\text{m}^3 \cdot \text{s}$)

G is the moisture source (kg/m^3)

$(\rho C_p)_{eff}$ is the effective volumetric heat capacity at constant pressure (J/K)

T is the thermodynamic temperature (K)

λ_{eff} is the effective thermal conductivity ($\text{W}/(\text{m} \cdot \text{K})$)

L_v is the latent heat for evaporation (J/kg)

δ_p is the vapor permeability coefficient of material (s)

ϕ is the relative humidity

p_{sat} is the partial pressure of saturated vaporation (Pa)

The stationary problem investigates the influence of thickness of insulation layer in the effective thermal conductivity of the wall, the heat flux, the moisture content at different operating temperature and relative humidity as shown in Table 2.7. Convective heat and moisture flux condition are applied on both sides to model the outdoor and indoor air flows surrounding the wall. The exterior and interior heat transfer coefficients are set as $h_e = 25 \text{ W}/\text{m}^2 \cdot \text{K}$ and $h_i = 8 \text{ W}/\text{m}^2 \cdot \text{K}$. The outer and inner moisture transfer coefficient are set to $\beta_e = 25 \times 10^{-8} \text{ s}/\text{m}$ and $\beta_i = 8 \times 10^{-8} \text{ s}/\text{m}$, according to the heat and mass transfer boundary layers analogy.

The thermal transmittance value (noted as U-value), also called the overall heat transfer coefficient refers to how well an element conducts heat from one side to another side. For a multilayer wall due to layers of different materials with different physical and thermal properties (thickness and thermal conductivity), it is often used the overall heat transfer coefficient, given as Eq. (2.5)

$$\text{The overall heat transfer coefficient } (W/m^2 \cdot K), U = \frac{1}{R_{total}} = \frac{1}{R_{conv,i} + R_{ins} + R_{conv,o}} \quad (2.5)$$

where $R_{conv,i}/R_{conv,e}$ is the thermal resistance of internal heat convection/external heat convection on the surface of wall, and R_{ins} is the thermal resistance of insulation materials.

Table 2.7 Boundary conditions for stationary study of the influence of temperature, relative humidity in thermal characterization of multi-layered insulators at different thicknesses of insulation layer.

Thickness	Temperature ($^{\circ}\text{C}$)	Relative humidity (%)
-----------	------------------------------------	-----------------------

(mm)	External	Internal	Inside	Outside
50	0	10	50	33
	0	10	50	57
	0	10	50	75
120	0	10	50	33
	0	10	50	57
	0	10	50	75
150	0	10	50	33
	0	10	50	57
	0	10	50	75
200	0	10	50	33
	0	10	50	57
	0	10	50	75
50	5	15	50	33
	5	15	50	57
	5	15	50	75
120	5	15	50	33
	5	15	50	57
	5	15	50	75
150	5	15	50	33
	5	15	50	57
	5	15	50	75
200	5	15	50	33
	5	15	50	57
	5	15	50	75
50	10	20	50	33
	10	20	50	57
	10	20	50	75
120	10	20	50	33
	10	20	50	57
	10	20	50	75
150	10	20	50	33
	10	20	50	57
	10	20	50	75

200	10	20	50	33
	10	20	50	57
	10	20	50	75

Study II – Heat and moisture transfer in the multi-layered insulation materials in the dynamic boundary conditions

This study investigates the moisture content, the changes of the effective thermal conductivity, and the heat flux under the effect of the diurnal variation of outside temperature and relative humidity in Sopron from 1st to 3rd of June and 1st to 3rd of December. The simulation is run over two days with the temperature and relative humidity conditions shown on the graphs of Fig. 2.14 (data from the ASHARE 2017 database).

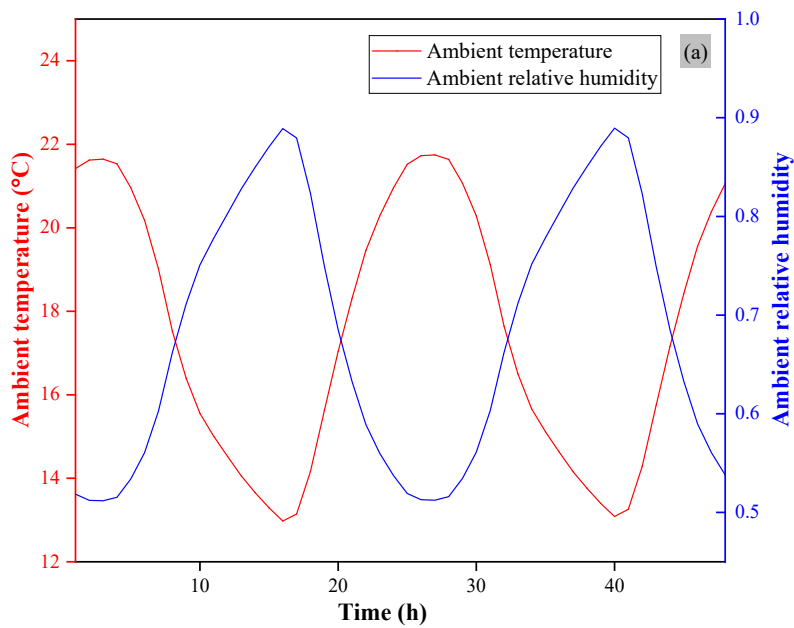

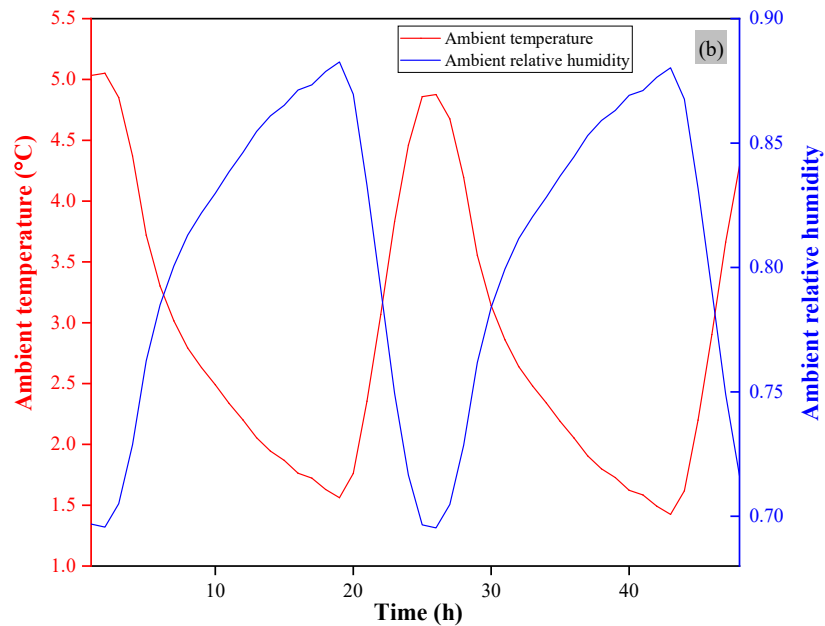

Figure 2.14 Ambient data for temperature and relative humidity used on the exterior side of the wall: **(a)** summertime; **(b)** wintertime.

2.4 Summary

This chapter presents the details on the extraction of fiber from raw plant material resources. The fabrication of binderless fiberboard insulation materials and bio-based polymer composites derived from natural plant-based resources is briefly introduced. The methods for experimental investigation on thermal conductivity test, temperature and moisture content dependence of thermal conductivity coefficient, water absorption, moisture content percentage related to humidity level, thermogravimetric analysis, morphological analysis are also discussed.

Insulation materials derived from plant-based resources or biocomposites reinforced with natural fiber are currently being used in building and construction as a potential solution to significantly reduce thermal load and energy consumption. For binderless insulation materials, they have proved a good heat retardant capacity due to their low thermal conductivity and low effect on human health. When natural fiber insulating materials are used as an additional layer in multi-layered installation, they have also exhibited better thermal performance and have met the requirements of the low-energy building. As expected, natural fibrous materials have shown an effective resource used as raw materials in reinforcement polymeric biocomposites and has been valued as an effective replacement for traditional resources in the future.

The numerical simulation of the heat and moisture transfer of the multi-layered insulation materials used for building envelopes has been investigated to evaluate the thermal performance regarding the variations of temperature and humidity levels, and the risk of condensation inside the natural fibrous insulation materials regarding the diurnal variation of outdoor environmental conditions.

CHAPTER III: RESULTS AND DISCUSSION

3.1 Determination of thermal conductivity coefficient of insulation materials

The thermal conductivity plays an important role in determining the thermal performance and energy efficiency of insulation materials, especially when they are used for building and construction. The lower the λ -value, the more effective the thermal insulator, or the higher the thermal resistance, the high heat-retardant capacity. As insulation materials are exposed to surroundings, under the influence of actual temperatures and humidity levels change over the days and seasons, the thermal performance can be greatly reduced. According to existing knowledge, the thermal conductivity of cellulose fiber-based insulation materials generally measured in the dry state at room temperature according to ASTM standards ranging from 0.03 to 0.06 W/(m·K) [16], and may reach to 0.2 W/(m·K) [135,136].

3.1.1. Thermal conductivity of natural fiber reinforced polymer biocomposites

The thermal conductivity values of coir fiber reinforced phenol formaldehyde (PF) biocomposites (CFPC) and rice straw/reed fiber reinforced PF biocomposites (REPC) measured at a mean temperature of 20 °C in the steady state using the heat flow meter method are shown in Table 3.1. As is seen on the table, the thermal conductivity values of CFPC showed a superior insulation quality than the REPC as their values were recorded at around 0.06 W/(m·K) while the λ -value of REPC were recorded at around 0.1 W/(m·K). However, the obtained thermal conductivity values are found to indicate the high-insulated property and demonstrate the produced biocomposite panels could perform as prominent building insulation material.

Generally, the thermal conductivity of natural fiber reinforced polymer composites was normally governed by the thermal conductivity of raw fibrous materials which usually ranged from 0.03 to 0.06 W/(m·K) [137], and the thermal conductivity of the resin is often insulated according to Bavan and Kumar [138]. As the heat conduction of an insulating material is heavily influenced by the raw materials used, the temperature and moisture content, the density, the nature and microstructure of solid component, and the cell gases. Therefore, the low value of thermal conductivity of CFPC and REPC possibly came from the low thermal conductivity of coir fiber which is 0.04–0.05 W/(m·K) while the thermal conductivity of rice straw and reed fiber are 0.038–0.072 W/(m·K) and 0.055–0.09 W/(m·K) [16]. On the other hand, the rice straw has a higher thermal capacity as it is reported at 1600 J/(kg·K) [97] when compared to coir fiber which is 1300 J/(kg·K) [16]. Besides, the phenolic resin also contributed on the heat conductivity due to its thermal conductivity coefficient is from 0.29 to 0.32 W/(m·K) and its moisture content was nearly 34% [139]. Moreover, the high λ -value of REPC also might

come from the initial moisture content of the mats which was found at approximately 12%, while the moisture content of the CFPC was about 3.08–3.18%.

Table 3.1 Thermal conductivity and thermal resistance values of coir fiber reinforced phenolic resin biocomposites (CFPC) and rice straw/reed fiber reinforced phenolic resin biocomposites (REPC).

Samples	Apparent Density (kg/m ³)	λ-value W/(m·K)	R-value (m ² ·K)/W
CFPC-a	894.48	0.0615 (\pm 0.0050)	0.130
CFPC-b	648.03	0.0620 (\pm 0.0067)	0.129
CFPC-c	453.30	0.0624 (\pm 0.0011)	0.128
REPC-a	725.00	0.1038 (\pm 0.0061)	0.116
REPC-b	742.79	0.1045 (\pm 0.0069)	0.115
REPC-c	764.49	0.1048 (\pm 0.0057)	0.115

The thermal resistance of these polymer biocomposites was calculated from the respective thickness and their measured thermal conductivity. It is found that the values were quite low and less than 0.15 (m²·K)/W possibly due to the relative thinness of the tested specimens. As the heat flow is indirectly proportional to the thickness of material, therefore, the lower thickness means more heat flow and so does a higher conductivity. However, the CFPC samples demonstrated superior heat resistant capacity because of their low thermal conductivity varied from 0.0615 to 0.0624 W/(m·K) which were considered as a good building insulation material. While their R-value was low, it could improve the heat insulated quality when they were employed as an additional insulation layer in the multi-layered installation used as building exterior structure. For example, Yuan investigated the impact on insulation type and thickness on the thermal performance of a multi-layered wall structure. The total R-value was calculated as 1.26 (m²·K)/W in case of non-insulated layer [113]. Supposing that the CFPC and REPC were used as an additional insulation layer, the total thermal resistance showed a slight increase, specifically, 1.4 (m²·K)/W and 1.395 (m²·K)/W, respectively. As a result, the heat-retardant capacity of the wall was improved.

3.1.2. Thermal conductivity of cross-laminated coconut wood insulation panels

The thermal conductivity values of four cross-laminated coconut wood insulation panels (CTCP) measured at a mean temperature of 20 °C are shown in Table 3.2. It is found that CTCP-a displayed lowest value of thermal conductivity, whereas the highest value found for CTCP-d.

The high conductivity possibly came from the contribution of the high conductance of wood at higher densities and the relatively high thermal conductivity of the used adhesive (the thermal conductivity of melamine formaldehyde was reported as 0.27–0.42 W/(m·K), [140]). In addition, the difference between these values might come from the different densities due to the interaction with the wood laminations during hot pressing. Generally, thermal conductivity of wood was within the range of 0.1–0.2 W/(m·K) perpendicular to the grain, for instance, the λ -value of kiri wood was found to be 0.117 W/(m·K) for the density of 357 kg/m³ [141] However, thermal conductivity of CTCP was relatively low compared with that of structural concrete (i.e., foamed concrete) used in building construction (~ 0.40–0.57 W/(m·K), [142]). Although the thermal resistance values of CTCP were lower than 0.5 (m²·K)/W, however, they showed a higher value than the result of cross-laminated timber made with pinus oocarpa and coffea arabica waste at the same density (0.115 (m²·K)/W) [143]. In general, the obtained thermal conductivity values showed that these coconut wood panels have a potentiality to be used in an exterior wall system from the energy and structural perspectives.

Table 3.2 Thermal conductivity and thermal resistance values of cross-laminated coconut wood insulation panels (CTCP).

Samples	Apparent Density (kg/m ³)	λ-value W/(m·K)	R-value (m ² ·K)/W
CTCP-a	624.87	0.1644 (\pm 0.00013)	0.365
CTCP-b	752.07	0.1928 (\pm 0.00023)	0.311
CTCP-c	828.69	0.2195 (\pm 0.00035)	0.273
CTCP-d	989.41	0.2468 (\pm 0.00029)	0.243

3.1.3. Thermal conductivity of binderless natural fiber-based insulation boards

Table 3.3 Thermal conductivity and thermal resistance values of binderless coir fiber insulation boards (BCIB) and binderless bagasse fiber insulation boards (BBIB).

Samples	Apparent Density (kg/m ³)	λ-value W/(m·K)	R-value (m ² ·K)/W
BCIB-a	56.0	0.0405 (\pm 0.00101)	0.740
BCIB-b	42.0	0.0490 (\pm 0.00015)	0.810
BCIB-c	33.6	0.0545 (\pm 0.00125)	0.920
BBIB-a	85.7	0.0429 (\pm 0.0004)	0.466
BBIB-b	101.8	0.0435 (\pm 0.0005)	0.575

BBIB-c	131.4	0.0530 (± 0.0008)	0.566
--------	-------	-------------------------	-------

The thermal conductivity values of three binderless coir fiber insulation boards (BCIB) and three binderless bagasse fiber insulation boards (BBIB) measured at mean temperature of 20 °C using heat flow meter method were found in the range of 0.04–0.055 W/(m·K) as shown in Table 3.3. It is seen that BCIB-a and BBIB-a displayed lowest values of thermal conductivity (0.0405 W/(m·K) and 0.0429 W/(m·K), respectively), while the highest values found for BCIB-c (0.0545 W/(m·K)) and BBIB-c (0.053 W/(m·K)). For binderless fiber-based insulation materials, the heat transfer mainly comprises of heat through the solid fiber and void components present in the matrix structure. While the thermal conductivity value of coir and bagasse fiber usually varies from 0.04 W/(m·K) to 0.05 W/(m·K) or lower than 0.04 W/(m·K) (i.e., the thermal conductivity values of bagasse solid fiber were found ranging from 0.0322 to 0.0348 [146]), and the air presents in the void or open pores of the matrix has low heat conductance, therefore, resulting in the low value of thermal conductivity of the tested specimens. Some published articles were reported the similar values of thermal insulation made of coir and bagasse fiber without the addition of any synthetic binders, for instance, the thermal conductivity of binderless coir insulation boards in the density range of 250–350 kg/m³ increased from 0.046 to 0.068 W/(m·K) measuring according to ISO 8301 [21] or from 0.048 to 0.056 W/(m·K) in the density range of 40–90 kg/m³ measuring according to ASTM C518 [53]. Another article also found that the binderless board made from cotton stalk fibers had the thermal conductivity ranging from 0.0585 to 0.0815 W/(m·K) at a density of 150–450 kg/m³ [144]. Interestingly, the λ -value of BBIB showed a similar result with the λ -value of binderless wood waste fiberboard which were found ranging from 0.048 to 0.055 W/(m·K) [91]. Other bagasse fiber-based composites were also found having the low range of the λ -value such as bagasse fiber reinforced with polyvinyl composites ranged between 0.034 and 0.042 W/(m·K) in the density range of 100–200 kg/m³ [145]. For the reinforcement composites, their λ -value normally recorded at a higher value due to the large heat conductance of the mixture and the adhesive resin, for example, thermal conductivity value of hybrid composites made of bagasse and bamboo charcoal were found in the range of 0.12–0.13 W/(m·K) [147], or the thermal conductivity of REPC and CFPC was found in the present research. As a result, the obtained thermal conductivity values of the binderless fiber insulation boards manufactured in this study showed a better thermal performance than other bio-based polymeric composites measured in this research demonstrating that these produced binderless fiber based insulation boards could be performed as a prominent insulation material.

3.2 Examination of temperature-dependent thermal conductivity coefficient

3.2.1. Temperature-dependent thermal conductivity of cross-laminated coconut wood panels

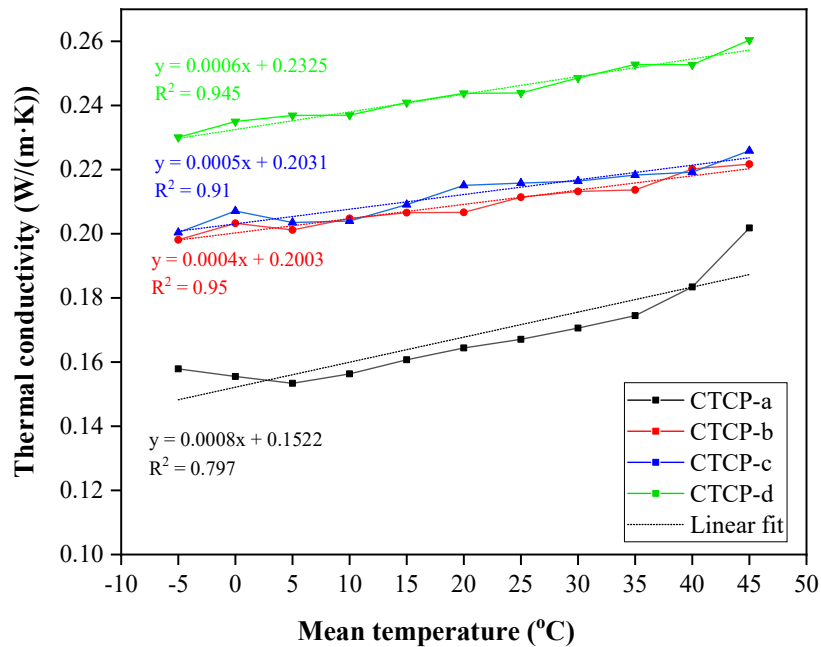

Figure 3.1 Thermal conductivity values of CTCP regarding the increase of mean temperatures.

The thermal conductivity values of four produced cross-laminated coconut wood insulation panels (CTCP) regarding the temperatures incremented by 5 °C from -10 to 50 °C with the temperature difference was remained at 10 °C is shown in Fig. 3.1. It is noticed that thermal conductivity showing an increasing trends with the increased mean temperatures due to the basic heat transfer law, as the temperature increases, the heat molecules vibrate faster, allowing for larger heat movements through conductance. Accordingly, the CTCP-d displayed highest values of thermal conductivity (increased from 0.23 W/(m·K) to 0.26 W/(m·K)) while the lowest values found for CTCP-a (from 0.16 W/(m·K) to 0.2 W/(m·K)). The values of CTCP-b and CTCP-c increased at approximately from 0.2 W/(m·K) to 0.22 W/(m·K)). This result was similar with the values of thermal conductivity of coconut palm trunk in the study [149]. As is also seen in the figure, the λ -value tended to increase from 5 °C and being remained this trend at a higher temperature level. Notably, the changes in thermal conductivity of the CTCP-a over the mean temperature ranges were relatively high, especially after 35 °C at a rate of 0.0008 W/m·K/°C, while the others ranged from 0.0004 to 0.0006 W/m·K/°C. This might be because its initial moisture content at the measuring time was high (~15.1%) since compared with other

samples (about 10.5–14.8%). In addition, the high λ -value also caused by the specific heat capacity of the coconut wood since it increased from 1360 J/(kg·K) to 1900 J/(kg·K) from the dry state to the moisture level of 15% [150]. As the thermal conductivity was measured in the steady-state condition and solely considered the heat conductance, the positive linear relationships were found between the λ -value and the mean temperature which were similar to that of oven-dry solid softwoods and hardwoods [56].

Thermal conductivity values of CTCP regarding the increase of density

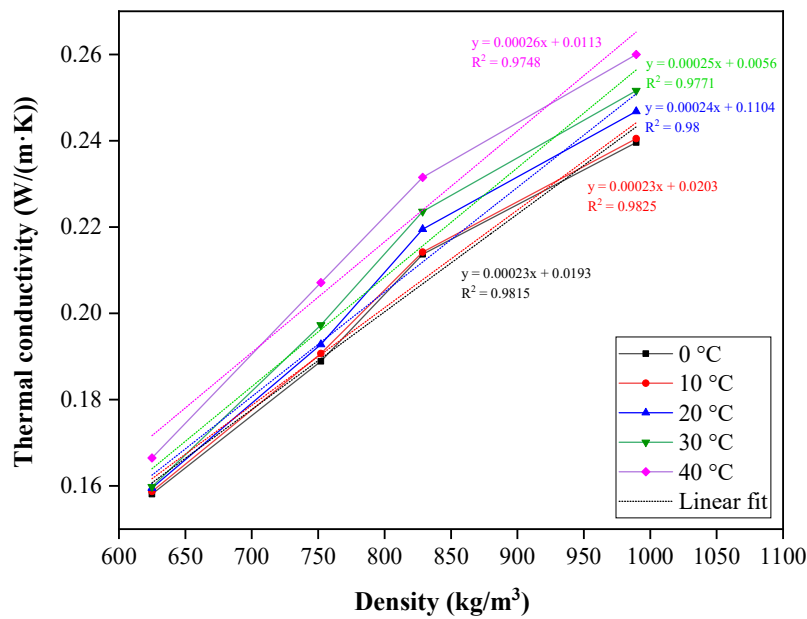

Figure 3.2 Thermal conductivity values of CTCP regarding the increase of density at different mean temperatures.

The λ -value of CTCP regarding the increase of density at five different mean temperatures is shown in Fig. 3.2. It is seen that the thermal conductivity of the produced CTCP appeared to increase with the increase of the panel's density at five mean temperatures. This is because the high-density wood conducts more heat than low-density wood due to the high heat conduction at a higher solid substance [151], and the decrease of porosity at high densities [23]. The lowest values were recorded at the density of 624.87 kg/m³ while the highest values found for the density of 989.41 kg/m³. However, it is also shown that the λ -value is always higher at a higher mean temperature for the same density. The linear functions could effectively describe the relationship between λ -value and bulk density of CTCP at any mean temperature with a high

coefficient of determination (see in the figure). Interestingly, the increasing rate of thermal conductivity (the slope) resulting from the increased density seemed to be similar and steadily increased regarding the increase of mean temperature, possibly due to the amount of coconut wood and the adhesive type used in the panels. Moreover, the values of thermal conductivity of CTCP (0.1581–0.26 W/(m·K)) and the increasing rate resulting from the increased density (624.87–989.41 kg/m³) were lower than that of engineered bamboo products of similar density ranges (626–960 kg/m³) which were reported of 0.2 to 0.35 W/(m·K) [152], showing that the produced cross-laminated coconut wood insulation panels had a superior heat insulated quality.

3.2.2. Temperature-dependent thermal conductivity of binderless coir fiber insulation boards

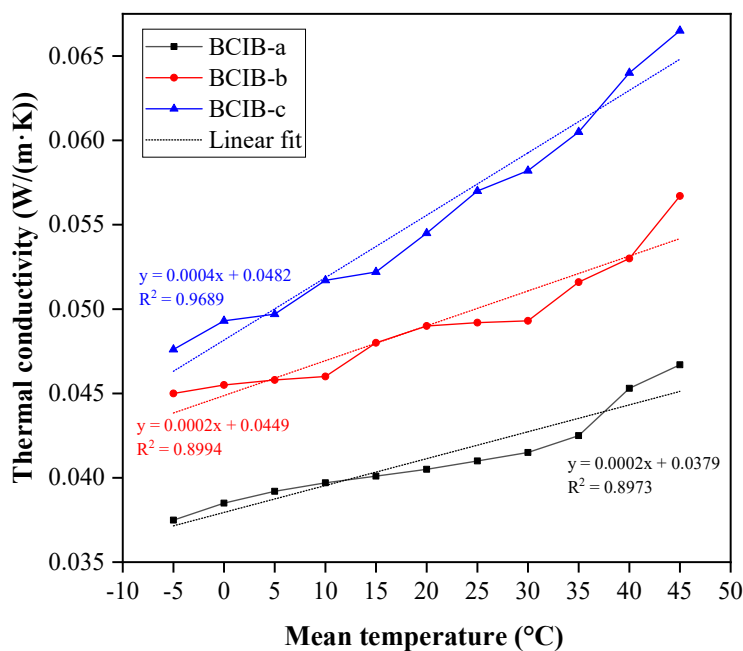

Figure 3.3 Thermal conductivity of BCIB regarding the increase of mean temperatures.

Fig. 3.3 presents the thermal conductivity values of three binderless coir fiber insulation boards regarding the increase of operating temperatures from -10 to 50 °C and the temperature difference remained constant at 10 °C. At it can be observed from the graph, the BCIB-c showed a maximum thermal conductivity value (0.0665 (±0.00106) W/(m·K)) at the highest mean temperature (45 °C) while the BCIB-a revealed a lower value (0.0467 (±0.00205) W/(m·K)) and the λ -value of BCIB-b was 0.0567 (±0.00151) W/(m·K) at the same mean temperature. For natural fiber based insulation materials, the thermal conductivity values mainly comprise of the contribution of pure fiber solid material (for coir fiber, the thermal conductivity is 0.04–0.05

according to approval, [16]), the water present, and the air. The higher values of the BCIB-c sample were possibly due to its initial moisture content at approximately 9.77% and because of the lower density (33.6 kg/m^3). At a higher density, due to the reduction of the internal voids and the closed pores, thereby decreasing the effect of moisture diffusivity from the water uptake. As a result, heat conductivity was mainly from the fiber and air conduction. This had explained the low thermal conductivity values of the BCIB-a sample. It is also observed that higher temperature levels always revealed higher thermal conductivity values, especially in the mean temperature range of $35\text{--}45 \text{ }^\circ\text{C}$ as is seen from the figure. The percentage changes in the thermal conductivity values were found of approximately 25%–45%. The increasing linear relationships between the values of thermal conductivity and mean temperatures were found according to the experimental values and the linear regression technique, which are similar to that of coir fiber [53], or concrete insulation materials made of hemp, flax, and straw bale [55] demonstrating that the changes in temperature have always been ascribed to the variation of thermal conductivity. As the thermal conductivity values of the BCIB samples ranged from 0.0375 to $0.0665 \text{ W/(m}\cdot\text{K)}$ and even higher than that of closed-cell foam materials but these binderless coir fiberboards could be performed as prominent thermal insulation materials.

Thermal conductivity values of BCIB regarding the increase of density

Fig. 3.4 presents the influence of density in the thermal conductivity values of BCIB at five levels of mean temperatures ($0, 10, 20, 30,$ and $40 \text{ }^\circ\text{C}$). According to some existing studies, natural fibrous materials such as sugarcane, palm, coconut fibers were reported the non-linear decreased variation in which the thermal conductivity decreased to a minimum and then increased slightly as density increased from the minimum possible value upwards [96,106]. This can be explained by three phenomena include bubble size, complexity of the matrix structure, and the number of solid fibers. As shown in the figure, the thermal conductivity decreased with the increased density, and higher values of thermal conductivity are associated with higher mean temperatures for the same densities. Generally, a decrease in thermal conductivity values as the density increases was due to the reduction of the voids in the fiber matrix resulting in a decrease in heat convective conductance as well as a restriction of water uptake into the cell walls of the fibers leading to a low effect of moisture absorption, thus, decreasing the apparent thermal conductivity. In addition, in the low range of density (lower than 120 kg/m^3), conductivity decreased as density increased due to the low effect of long-wave radiant exchange inside the pores as it was reported in the study [23].

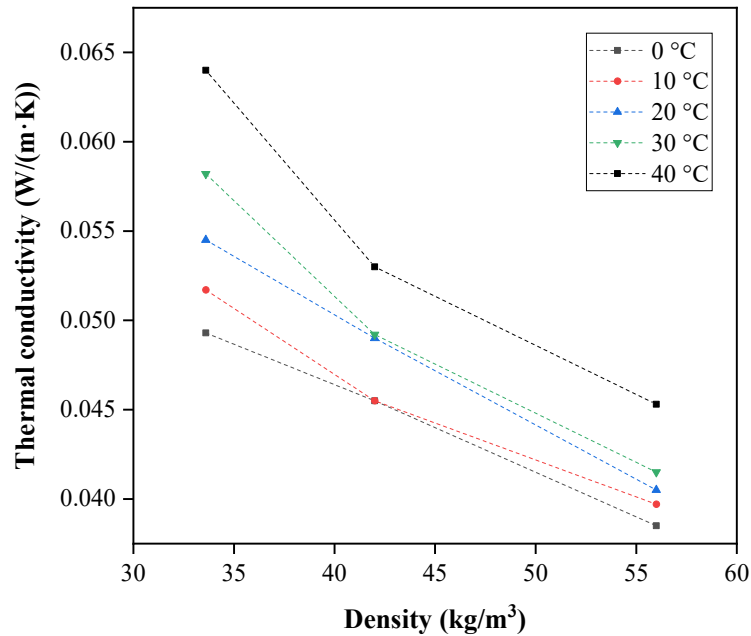

Figure 3.4 Thermal conductivity values of BCIB regarding the increase of density at different mean temperatures.

3.2.3. Temperature-dependent thermal conductivity of binderless bagasse fiber insulation boards

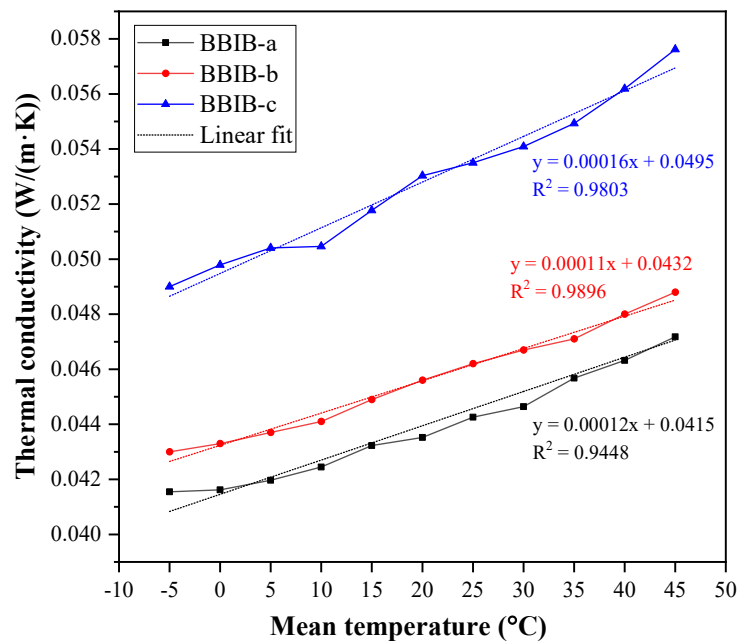

Figure 3.5 Thermal conductivity of BBIB regarding the increase of mean temperatures.

Fig. 3.5 performs the thermal conductivity values of three binderless bagasse fiber insulation boards regarding the increase of operating temperatures from -10 to 50 °C with the temperature difference remained constant at 10 °C. As is seen from the graph, the increasing tendency is recorded for all tested samples, and higher values of thermal conductivity are always associated with higher temperatures. This is explained by the basic heat transfer law, as the temperature increases, the heat molecules vibrate faster, allowing for larger heat movements through conductance. Besides, the thermal conductivity of bagasse fiber was found to range between 0.03 and 0.04 W/(m·K) and the thermal conductivity of the air existing in the fiber matrix was around 0.0259 W/(m·K), resulting in the low value of thermal conductivity of the specimens. On the other hand, the low thermal conductivity values of the present binderless bagasse insulation boards were also from the low moisture content existence in the tested samples at the measuring time (as it was found at around 7.5%). Specifically, the BBIC-a and BBIC-b increased from around 0.04–0.042 W/(m·K) to around 0.046–0.048 W/(m·K) while the BBIC-c started from 0.049 W/(m·K) to the highest value of 0.057 W/(m·K). Accordingly, the percentage changes in the thermal conductivity values were found to increase approximately from 15 to 20%. These λ -value of BBIB in the present study were similar to the thermal conductivity of sugarcane bagasse samples in the study of Manohar et. al. [53], which were found to increase from 0.049 to 0.051 W/(m·K) since the mean temperature increased from 18 to 32 °C for the density range of 110–120 kg/m³, or the polyester composites made of hem and flax, which were also found that the λ -value increased from 15.13 to 18.62% when the temperature increased in the range of 0–40 °C [90]. Another study on the thermal conductivity of binderless insulation panels made of spruce bark fiber also reported the similar increase since the temperature increased from 10 to 40 °C [153]. According to previous studies, the thermal conductivity values of binderless fiber insulation boards which were produced by the heating method measured at room temperature using a heat flow meter in the steady-state and one-dimensional condition ranged from 0.046 to 0.068 W/(m·K) [21,53], or reported as lower than 0.045 W/(m·K) [145]. Therefore, the obtained thermal conductivity values of the tested binderless bagasse boards are found to provide comparatively better results demonstrating that these binderless bagasse fiber insulation boards could perform as prominent building insulation materials. The relationships between the λ -value and mean temperature levels were found and expressed as linear functions based on the experimental data with the high coefficient of determination demonstrating the strong influence of temperature in the thermal conductivity of insulation materials.

3.3 Investigation of water absorption of natural fiber insulation boards

3.3.1. Water absorption of binderless coir fiber insulation boards

Moisture effect plays an important role in investigating the thermal resistant quality of insulation materials derived from natural fiber used in building envelopes. Water uptake tests of binderless coir fiber insulation boards (BCIB) were conducted using the controlled climatic chamber method. Three samples of BCIB were placed in the climatic chamber and exposed to five expected levels of humidity (15, 40, 60, 80, and 95%). The lowest level of humidity (15%RH) was generated by using the silica gel to absorb the water presents in the humid air inside the chamber. After reaching the equilibrium state, the samples were weighted to calculate the water absorption, and the actual humidity level in the chamber was recorded.

The curves in Fig. 3.6 reflect the changes in water absorption percentages of three binderless coir fiber insulation boards (BCIB) in regard to five actual levels of relative humidity were recorded from the climatic chamber. The actual humidity levels were found of 16.5% (± 0.57), 40.1% (± 0.78), 59.8% (± 0.8), 76.2% (± 2.35), and 90.5% (± 1.54). As is seen in the graph, the samples showed a similar sorption behaviour, and they exhibited a typical behaviour of natural fibers with a high increase of moisture absorption above 76.2% relative humidity. The lowest values of moisture content was recorded at approximately 7.66% and slightly increased to around 9.7% when the humidity increased from 16.5% to around 40%. This is because there is a small amount of water vapour in the air at low level of humidity (usually below 40%RH). As humidity increases, water vapour starts to condense on the cell walls of the fibers. This condensation phenomenon contributes a significant amount to the water absorption of fibers in high humidity levels. More specifically, the moisture content showed a significant increase at the higher levels of humidity due to the high absorption of water molecules in the fiber and matrix interfaces through the capillary transport and via microcracks in the matrix which resulted from the swelling of natural fiber. Especially, the BCIB-c highlighted a high absorbency at around 23.54% (relative to 90.5%RH) compared to BCIB-a and BCIB-b reached about 14.38% and 18.55%, respectively. The similar trend is found to be similar with composites made of hemp, flax, and cotton fiber from the articles [154,155].

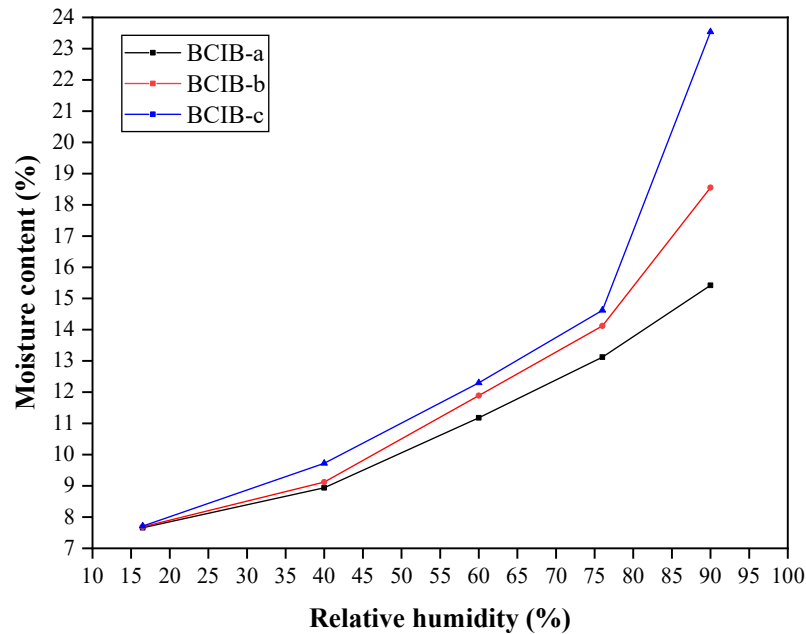

Figure 3.6 Moisture content of BCIB regarding the increase of relative humidity levels.

3.3.2. Water absorption of binderless bagasse fiber insulation boards

Fig. 3.7 illustrates the water absorption percentages of bagasse fiberboards in regard to the absorbent time. The tested samples were conditioned in the desiccator containing saturated sodium chloride solution to generate the 75% relative humidity. This experiment aims to investigate the duration for the water absorption of natural fiber-based samples reaching the equilibrium saturation level. Results showed that samples followed typical Fickian diffusion behaviours. Water absorption occurs rapidly at the beginning of exposure with water, however, after time, the absorption rate slows down until reaching the point of equilibrium. As it is seen from the graph, the moisture uptake was relatively high for the first stage of 7–14d, possibly due to a large number of water molecules diffusing through the material starting from the dry state of the absorbency process. From 14 to 28 days, it seems that the pores and capillaries of bagasse fiber which were initially filled with air were steadily replaced by absorbed water leading to a minor change in the mass and almost stable after 30 days. As a result, the saturated level of binderless bagasse fiberboard specimens took approximately 28–35d to be obtained.

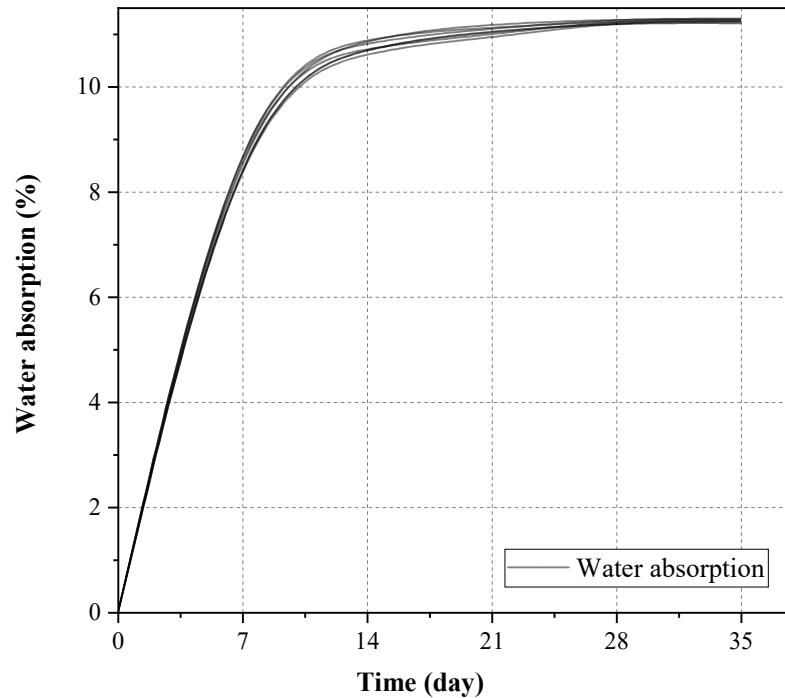

Figure 3.7 Water absorption percentages of bagasse fiberboard regarding the absorbent time.

A series of equilibrium moisture content of binderless bagasse insulation boards (BBIB) at room temperature regarding the increased humidity levels from 33 to 96% is shown in Fig. 3.8. The BBIB samples were conditioned in different humidity levels in the sealed desiccator containing four saturated salt solutions (see Table 2.6). The use of salt solutions for determining the water absorption of natural fibrous materials was also found in the study [97]. As it is observed from the graph, the tested samples also showed a similar sorption behaviour in that higher relative humidity levels always displayed higher moisture content percentages. Accordingly, BBIB-c displayed higher values of moisture uptake than BBIB-a and BBIB-b. Their values increased from 12.1 to 17.33% while the values of BBIB-a and BBIB-b increased from 10.5 to 14.68% and 10.89 to 15.77%, respectively. In addition, they also exhibited a high increase of moisture content above 75% relative humidity. In the range of 75–96% relative humidity, the percentage rate of change in the moisture uptake was found of 15–17%, compared to other ranges were around 8.2 to 12%. For lower relative humidity values, the cell walls that compose the fibers absorb moisture from the environment in single and multiple layers. As relative humidity increases, water vapour starts to penetrate into the fiber and matrix interfaces through capillary transport and via microcracks in the matrix which result from natural fiber swelling. The cause of higher water absorption is also due to the presence of some hydrophilic

compounds in the natural fibrous structures which were detected in terms of transmittance of FT/IR spectra measurement (section 3.6). Although these samples had a similar moisture behaviour during the absorption phase, these samples showed a larger difference, possibly due to the intrinsic heterogeneity of the samples during the manufacturing process. In conclusion, the high moisture absorption of natural fibrous insulation materials is always related to high relative humidity due to their complex organic structure as well as their own hydrophilicity.

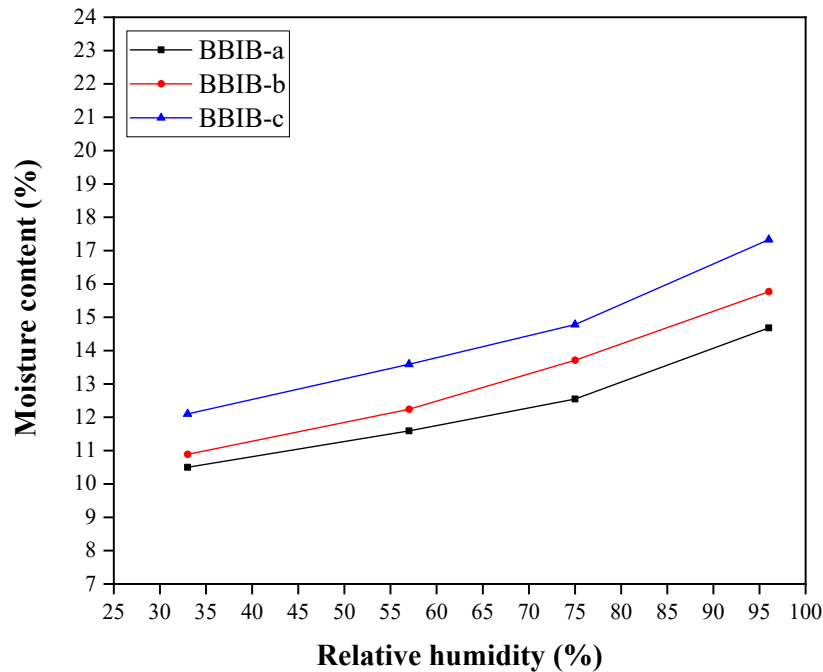

Figure 3.8 Moisture content of BBIB regarding the increase of relative humidity levels.

3.4 Examination of relative humidity dependence of thermal conductivity

3.4.1. Relative humidity dependence of thermal conductivity of binderless coir fiber insulation boards

Since the thermal conductivity of bio-based insulation materials depends on their moisture content, the thermal conductivity values of the specimens at different moisture states related to the humidity levels were examined after reaching the equilibrium state from exposure to the humid environment conditions.

The thermal conductivity values of binderless coir fiber insulation boards (BCIB) respective to moisture content percentages related to five levels of humidity are shown in Fig. 3.9. A similar increasing trend was observed for all tested specimens in that increased relative

humidity led to an increase in thermal conductivity values. The λ -value of BCIB-a, BCIB-b, and BCIB-c at the dry state were found of 0.041 W/(m·K), 0.049 W/(m·K), and 0.057 W/(m·K), respectively. It is shown that BCIB-c recorded higher values of thermal conductivity (increased from 0.069 to 0.107 W/(m·K)) while the values of BCIB-a and BCIB-b increased from 0.049 to 0.066 W/(m·K) and from 0.058 to 0.094 W/(m·K), respectively. This is because of the higher water absorption of BCIB-c than BCIB-a and BCIB-b as is presented in the previous section. In addition, an increase in λ -value came from the penetration of water molecules into the cell walls of the fibers and the open structures of the samples. The large heat conductance also caused by the high thermal conductivity of water at approximately of 0.6 W/(m·K) compared to the stationary air (0.0259 W/(m·K)). The possible relationship was found as linear functions between the thermal conductivity values and moisture content percentages with a high coefficient of determination demonstrating the strong influence of relative humidity in the thermal conductivity, which was similar to that of fiberglass insulation materials at the same range of moisture content [45]. On the other hand, the bulk density of the tested samples may contribute to the water absorption regarding the increase of humidity, therefore, influencing the whole heat conductance. Accordingly, as the density increased, the number of voids and open pores in the fibers structure decreased markedly resulting in a reduction of water penetration into the cell walls of the fibers, therefore, decreasing the moisture effect on thermal resistant quality [106].

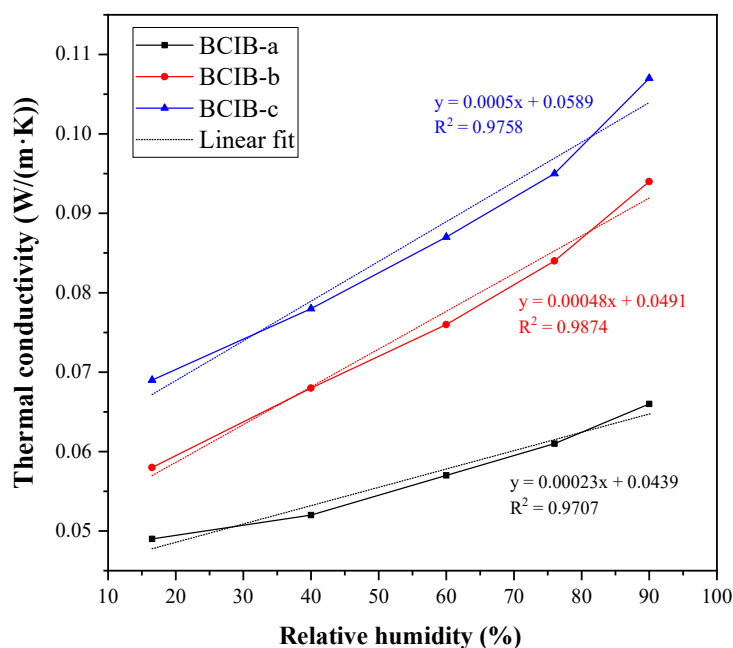

Figure 3.9 Thermal conductivity values of BCIB regarding the relative humidity levels.

3.4.2. *Relative humidity dependence of thermal conductivity of binderless bagasse fiber insulation boards*

The influence of relative humidity levels in the thermal conductivity values of binderless bagasse insulation boards (BBIB) is shown in Fig. 3.10. The moisture uptake test was conducted on three samples conditioned in the humidity levels of 33, 57, 75, and 96% which were generated in the sealed desiccator using the saturated salt solutions. After reaching the equilibrium state, the thermal conductivity was measured using the heat flow meter method at a mean temperature of 20 °C for all tested specimens.

It is seen that the specimens showed a similar increasing tendency in that higher values of thermal conductivity are associated with higher relative humidity levels. The λ -values of BBIB-a, BBIB-b, and BBIB-c at the dry condition were found of 0.043 W/(m·K), 0.044 W/(m·K), and 0.049 W/(m·K), respectively. The BBIB-c displayed higher values of thermal conductivity than the values of BBIB-a and BBIB-b. Their values increased from 0.058 to 0.069 W/(m·K), whereas the values of BBIB-a and BBIB-b increased from 0.044 to 0.049 W/(m·K) and from 0.046 to 0.052 W/(m·K), respectively. This is because the moisture absorption of BBIB-c is higher than the other BBIB samples. The similar results of hemp composite and binderless flax boards were found in the study [90] and the study of rice straw bale [156]. The thermal conductivity values of fiber-based insulation materials came from the contribution of pure fiber solid material, water, and air. Air remains trapped in the closed pores while they are steadily replaced, as the water content increases, by the water in the open pores. At the saturated state, water occupies the open pores leading to high heat transfer, therefore, increasing the thermal conductivity. Moreover, at higher densities, there is more bagasse fiber available to absorb moisture and the moisture uptake changes appear to have a greater influence on the results. The relationships between thermal conductivity values and the humidity levels were expressed as linear functions with high coefficient of determination proving the significant effect of relative humidity on the thermal conductance of natural fiber based insulation materials.

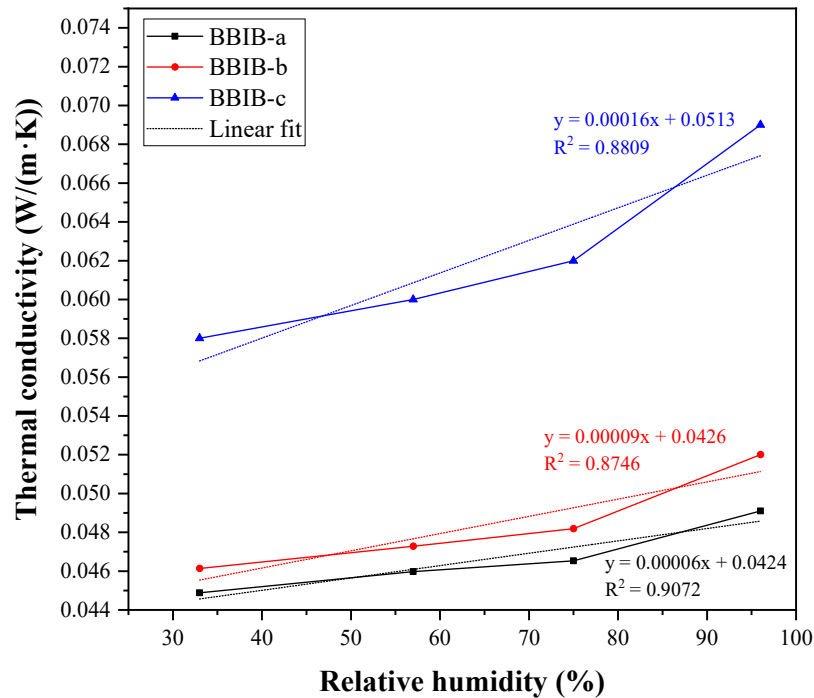

Figure 3.10 Thermal conductivity values of BBIB regarding the relative humidity levels.

As the cellulose fibers are the main components of the fiberboards, the water transport mechanisms in fiber insulation materials caused by the penetration of water molecules via the microcracks in the fiber matrix, diffusion of water molecules in the gaps between fibers, and also capillary transport at the interfaces of fibers matrix [157]. It causes difficulty in maintaining a good adhesion between fiber/matrix and contributes to higher moisture absorption which reduces the heat insulated performance. Numerous works have been reported the similar relationship between the thermal conductivity values of some building insulation materials and moisture content factor, such as, the thermal conductivity of date palm fiber composites increased from 0.033 W/(m·K) at a dry state to its maximum value of 0.147 W/(m·K) at saturated state [84], or Mahapatra et. al. also reported that thermal conductivity of bagasse ranged from 0.0921 to 0.1096 W/(m·K) and increased linearly with an increase in moisture content in the range of 8.52–28.62% [158]. Generally, the high thermal conductivity of natural fiber based insulation materials are notably caused by the presence of large amount of water in the fiber base, however, the bagasse fiber insulation boards manufactured in this research work provided a potentiality to be used as a good insulation material in buildings.

3.5 Surface morphology and morphological analysis of binderless bagasse fiber insulation boards

The surface morphology of binderless bagasse insulation board (BBIB) was examined using the digital microscope is shown in Fig. 3.11. As is seen from the image, the fiberboards were manufactured by the activation of the element's self-bonding feature due to the hydrogen bonds formation and adhesive behaviour of lignin and cellulose which occur during the drying process. However, it also showed a weak bonding between the fiber and the matrix interfaces as well as the existence of gaps between fibers on the surface resulting in high water penetration into the structures leading to the reduction of water resistance and dimensional stability.



Figure 3.11 Surface morphology of binderless bagasse insulation boards.

Fig. 3.12 shows the surface micrographs of the bagasse materials before disc refining process to achieve the finer particles. After grinding process, the bagasse particles show the presence of a large number of lignin and hemicellulose which provides the fiber a continuous enveloping layer for the cellulosic materials. This is common morphological structures of the untreated fiber as reported in some recent studies [161,162]. Fig. 3.12(a) shows one or a group of vascular bundle and elongated cells from the sheath can be identified while Fig. 3.12(b) shows the same but closer, and small pores can be also observed from this magnification.

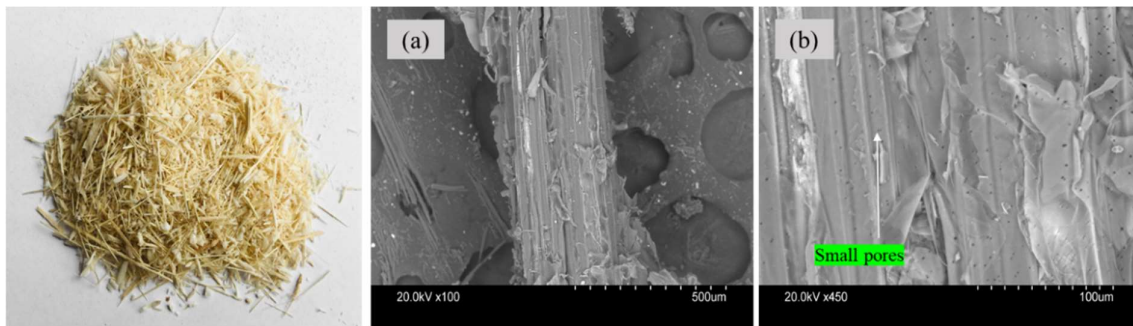

Figure 3.12 SEM micrographs of bagasse particles: (a) 100 \times ; (b) 450 \times (magnification bars with scale in μm are given on the photographs).

After disc refining process, the vascular bundles were broken into smaller pieces. The tightly fitting, thick-walled cells of the vascular bundles are also exposed to the twisting effect in the machine. In such cases, the cells and the bundles are torn apart by the force. Fig. 3.13 shows the existence of small pores and high roughness of the surface of the fibers. As the boards were manufactured without using adhesive resin, it is easy to create the fiber damage. However, as is reported in the study [145], the grooved and rough surfaces of the fibers lead to the formation of microscopic pockets of air on the fiber surface, leading to high thermal insulation properties.

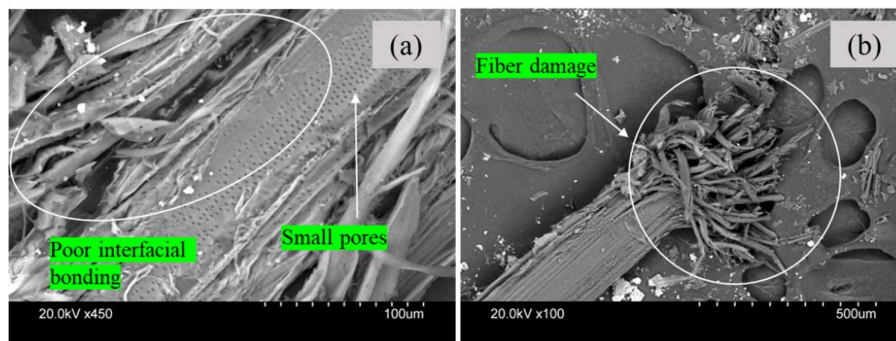

Figure 3.13 SEM micrographs of binderless bagasse fiber insulation boards: (a) 450 \times ; (b) 100 \times (magnification bars with scale in μm are given on the photographs).

3.6 Fourier transform infrared spectroscopic study

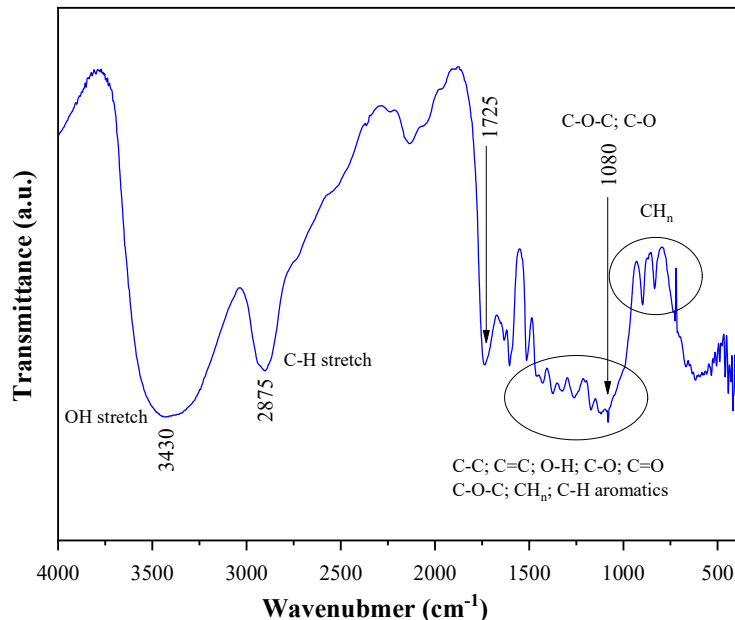

Figure 3.14 FTIR spectrum measurement of binderless bagasse insulation board.

Fig. 3.14 shows the spectrum of transmittance mode detected from the Fourier transform infrared (FTIR) spectrum measurement of the bagasse fiber insulation board. As the main components of the fiberboard are cellulose fiber, their functional groups can be detected further in terms of FTIR spectra. Firstly, the spectra revealed the presence of the hydrogen bonded stretching bands of -OH groups in the region of 3430 cm⁻¹ and within 1080–1500 cm⁻¹, the absorptions can be attributed mainly to the carbohydrates (cellulose and lignin), including C-O-C and C-O stretch. Secondly, the bands in the region 1725 cm⁻¹ can be contributed to unconjugated C=O stretching, and that near 1600 cm⁻¹ can be assigned to conjugate carbonyl present in typical lignin groups. In addition, the presence of moisture may be contributing to the deformation of water molecules near 1600 cm⁻¹ and also the contribution for the intensity of the broad band in the region of 3430 cm⁻¹. These results showed a similar to the spectra study of the bagasse fiber [163].

3.7 Thermogravimetric analysis (TGA)

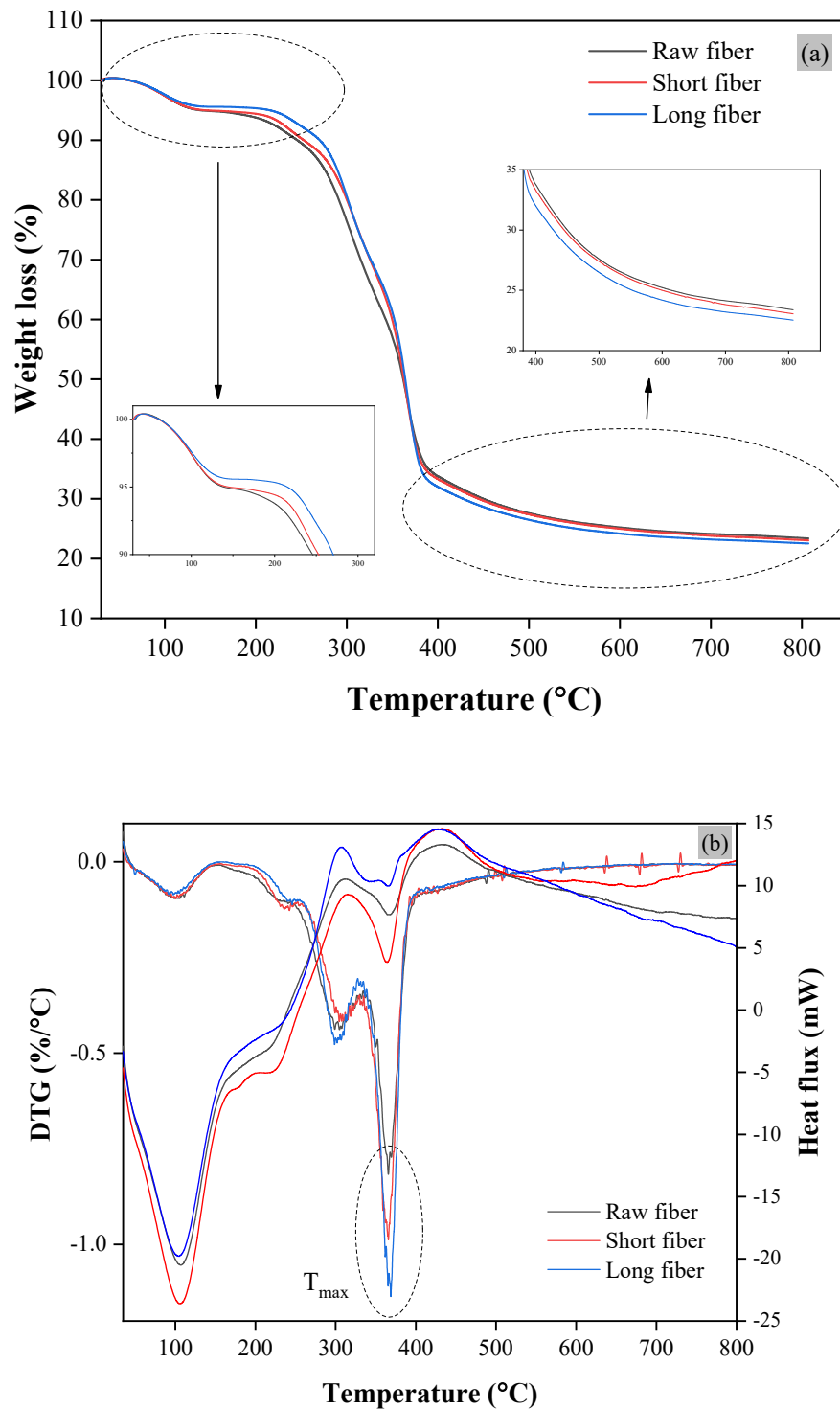

Figure 3.15 (a) Thermogravimetric analysis (TGA) curve, (b) The first derivative (DTG) of raw bagasse, bagasse particle, and long bagasse fiber.

The thermal degradation behavior of fiber and binderless bagasse fiber insulation board was analyzed by thermo-gravimetric analysis (TGA) and derivative thermo-gravimetric (DTG) at the temperature range 0–800 °C in nitrogen atmosphere. Generally, the TGA curves present three main phases of degradation in which the first phase is for the removal of moisture presence, followed by the destruction of cellulosic components and non-cellulosic compositions in the remaining two phases while the maximum of temperature in DTG related to the breaking of chemical bond of the lignin [164].

As observed from thermograms in Fig. 3.15, the first stage ranges from 30 to 100 °C which represents the water loss associated with moisture present in the fibers and the boards. Although the samples were dried before the analysis, total elimination of water was quite difficult due to the hydrophilic nature of the fibers base. The range of 150–400 °C represents the destruction of cellulosic components and the next stage from 400 to 800 °C indicates the degradation of non-cellulosic components. These results are similar with results from previous studies on bagasse fiber [163,165]. Regarding DTG graphs, the peak of 365 °C figures out the debonding of chemical bond of the protolignin (lignin present in the fibers).

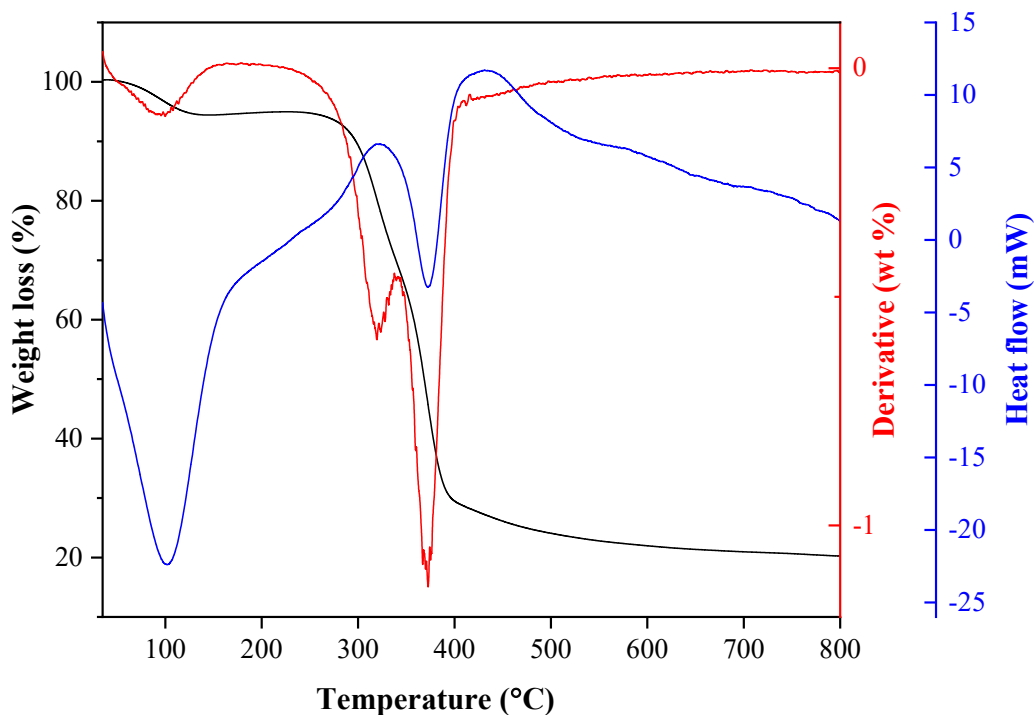

Figure 3.16 Thermogravimetric analysis curve and the first derivative of the TGA curve thermograms of bagasse fiber insulation board.

The TGA and DTG of binderless bagasse fiber insulation board are shown in Fig. 3.16 and the maximum temperature is valued in Table 3.4. It is observed that the portion of weight loss at first stage was reached at 93 °C, which could be related to the existence of moisture in the boards. The second phase of weight loss occurred at around 319.2 °C due to the destruction of cellulosic components and the last phase of weight loss completed at 372.5 °C. Compared to existing studies, the thermal behavior depicted a similar response to a bagasse fiber epoxy composite [166], or bagasse fiber reinforced cardanol polymer composites [167]. However, the heat stimulation was quite lower because of the absence of adhesive compounds in the insulation board. Overall, experimental results of TGA and DTA can contribute to the evaluation of the thermal stability of neat bagasse fiber and bagasse fiber reinforced polymer composites without treatment or the non-adhesive bagasse-based insulation boards.

Table 3.4 TG and DTA results for raw bagasse, long bagasse chip, bagasse particle, and binderless bagasse insulation board.

	Portion of weight loss, %				DTG peak (T_{max})
	Stage 1	Stage 2	Stage 3	Total	°C
Raw sugarcane	5.5	60.8	11.5	77.8	365.78
materials	4.8	64.1	8.5	77.4	365.83
	4.3	62.8	10.7	77.8	366.01
BBIB	5.9	64.8	9.7	80.4	372.85

3.8 Numerical simulations

Both operating temperature and relative humidity have a significant effect on the thermal energy performance of insulation materials. Employing experimental analyses, most of the studies have focused on determining the influencing temperature and moisture content in thermal conductivity in a steady-state condition in which its value can be determined independently at a specified mean temperature and relative humidity. In reality, it is essential to examine a simultaneous effect of temperature and moisture in thermal conductivity due to the heat transport transient process. Many scholars focused on the combined effect of heat and moisture transfer simultaneously on the insulation λ -value of materials, based on numerical simulation and experimental investigation [54,70,74,168-172].

3.8.1. Heat and moisture transfer through the multi-layered building insulation materials in stationary boundary conditions

According to the standard ISO 10456:2007 – Building materials and products – Hygrothermal properties, the effects of temperature and relative humidity are independent. However, when employing the insulation materials in the building applications, they will undergo the influence of the variations of temperature and relative humidity in the same time. In this simulation study, the thermal performance of the multi-layered insulation materials (OSB-CFB-OSB as described in section 2.3.8) including the effective thermal conductivity (λ_{eff}), the effective thermal resistance (R_{eff}), the thermal transmittance value (U-value) as well as the moisture content (MC) related to the ambient relative humidity were numerically investigated under the variations of temperature and relative humidity which were imported as the static boundary conditions.

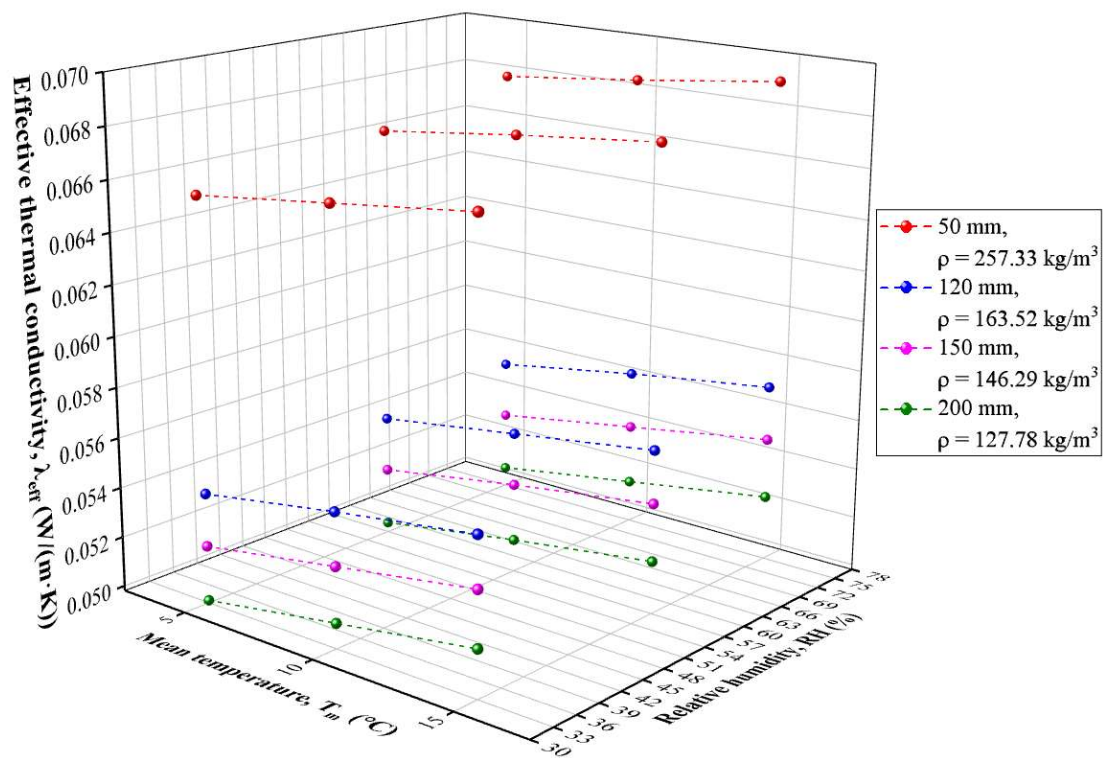

Figure 3.17 Influence of mean temperature and relative humidity in the effective thermal conductivity values of the multi-layered insulation materials at different thicknesses.

Fig. 3.17 shows the changes in the effective thermal conductivity of multi-layered insulation materials at different thicknesses of the cellulose fiberboard layer regarding the variations of temperature (from 5 °C to 15 °C) and relative humidity (33%–75%). The values

of effective thermal conductivity were calculated comprising of heat conduction in the structural layers due to the temperature difference between both sides and the heat convection between the surface and the indoor/outdoor environments. As it is observed from the graph, the λ_{eff} increased slightly with the increase of mean temperature from 5 to 15 °C and the increase of relative humidity from 33 to 75% for all cases. Obviously, the highest temperature (15 °C) and highest relative humidity (75%RH) showed a highest thermal conductivity value (0.0691 W/(m·K)) demonstrating that higher temperature and higher relative humidity are always associated with higher heat conductance. This is similar with the conclusions reported in a numerical problem was modeled to study four stages of heat and moisture transfer in porous insulation materials [173].

In fact, heat transfer mainly comprises of heat through the solid fiber and void components present in the matrix structure. The temperature dependency of the thermal conductivity is explained by the basic heat transfer law, as the temperature increases, the gas molecules vibrate faster, allowing for larger heat movements through conductance and convection. Similarly, the water vapor diffusion increases the λ_{eff} and at higher temperatures as well as relative humidity, the larger capacity to hold moisture, then, increases the λ_{eff} even more. Besides, the increasing rate of the effective thermal conductivity (the slope) resulting from the increased temperature and relative humidity was similar, possibly due to the density and the specific heat capacity did not change. Although the λ_{eff} increased with the increased relative humidity, this growth was not significant meaning that no significant reduction in thermal insulation performance occurred, which was similar to the report [145]. Despite the simulation revealed an increase in the λ_{eff} rose to 0.0691 W/(m·K), still the proposed multi-layered insulation materials can be considered as a good model for building application. The possible linear relationships between the effective thermal conductivity values and mean temperature, relative humidity are shown in Table 3.5 and Table 3.6. On the other hand, the figures also showed that the thickness of the insulation medium does not have a statistically significant effect on the λ_{eff} . This is due to the fact that λ_{eff} is the intrinsic property of a material and it does not change with the material thickness, but the bulk density does. As is simulated, the effective thermal conductivity showed an increase with increased bulk density at the same mean temperature levels and relative humidity percentages and these results were similar with the practical investigation [104,145]. However, as it assumed that the density did not change during the variation of temperature and relative humidity, therefore, it is needed to consider for improving the simulated results.

Table 3.5 Relationship between the λ_{eff} and mean temperature at different relative humidity levels expressed as a linear function.

Thickness (mm)	λ -T relationship					
	33%RH	R ²	57%RH	R ²	75%RH	R ²
50	$10^{-4}T + 0.065$	1	$10^{-4}T + 0.066$	1	$10^{-4}T + 0.0671$	1
120	$2 \times 10^{-4}T + 0.053$	1	$2 \times 10^{-4}T + 0.054$	1	$2 \times 10^{-4}T + 0.054$	1
150	$2 \times 10^{-4}T + 0.051$	1	$2 \times 10^{-4}T + 0.052$	1	$2 \times 10^{-4}T + 0.052$	1
200	$2 \times 10^{-4}T + 0.049$	1	$2 \times 10^{-4}T + 0.049$	1	$2 \times 10^{-4}T + 0.049$	1

Table 3.6 Relationship between the λ_{eff} and relative humidity at different mean temperatures expressed as a linear function.

Thickness (mm)	λ - ϕ relationship					
	5 °C	R ²	10 °C	R ²	15 °C	R ²
50	$4 \times 10^{-5}\phi + 0.064$	0.99	$4 \times 10^{-5}\phi + 0.065$	0.99	$4 \times 10^{-5}\phi + 0.066$	0.99
120	$2 \times 10^{-5}\phi + 0.054$	0.99	$2 \times 10^{-5}\phi + 0.054$	0.99	$2 \times 10^{-5}\phi + 0.055$	0.99
150	$2 \times 10^{-5}\phi + 0.052$	0.99	$2 \times 10^{-5}\phi + 0.053$	0.99	$2 \times 10^{-5}\phi + 0.053$	0.99
200	$10^{-5}\phi + 0.049$	0.95	$10^{-5}\phi + 0.050$	0.99	$10^{-5}\phi + 0.051$	0.98

The next figures depict the values of the effective thermal resistance (R_{eff}) calculated from the respective thickness and the effective thermal conductivity regarding the variation of temperature (Fig. 3.18) and relative humidity (Fig. 3.19). At the same relative humidity, the R_{eff} decreased slightly since the temperature increased from 5 to 10 °C due to the slight increase in the effective thermal conductivity. For instance, the R_{eff} decreased from approximately 0.75 ($\text{m}^2 \cdot \text{K}$)/W to around 0.72 ($\text{m}^2 \cdot \text{K}$)/W at the 50 mm thickness and from 4 ($\text{m}^2 \cdot \text{K}$)/W to around 3.89 ($\text{m}^2 \cdot \text{K}$)/W at the 200 mm thickness for all humidity levels. In a contrast, the higher relative humidity levels scored a significant decrease in the thermal resistance for all thicknesses, due to the increase of the thermal diffusivity at a higher temperature level resulting in an increase in the water diffusion and because the high thermal conductivity of water.

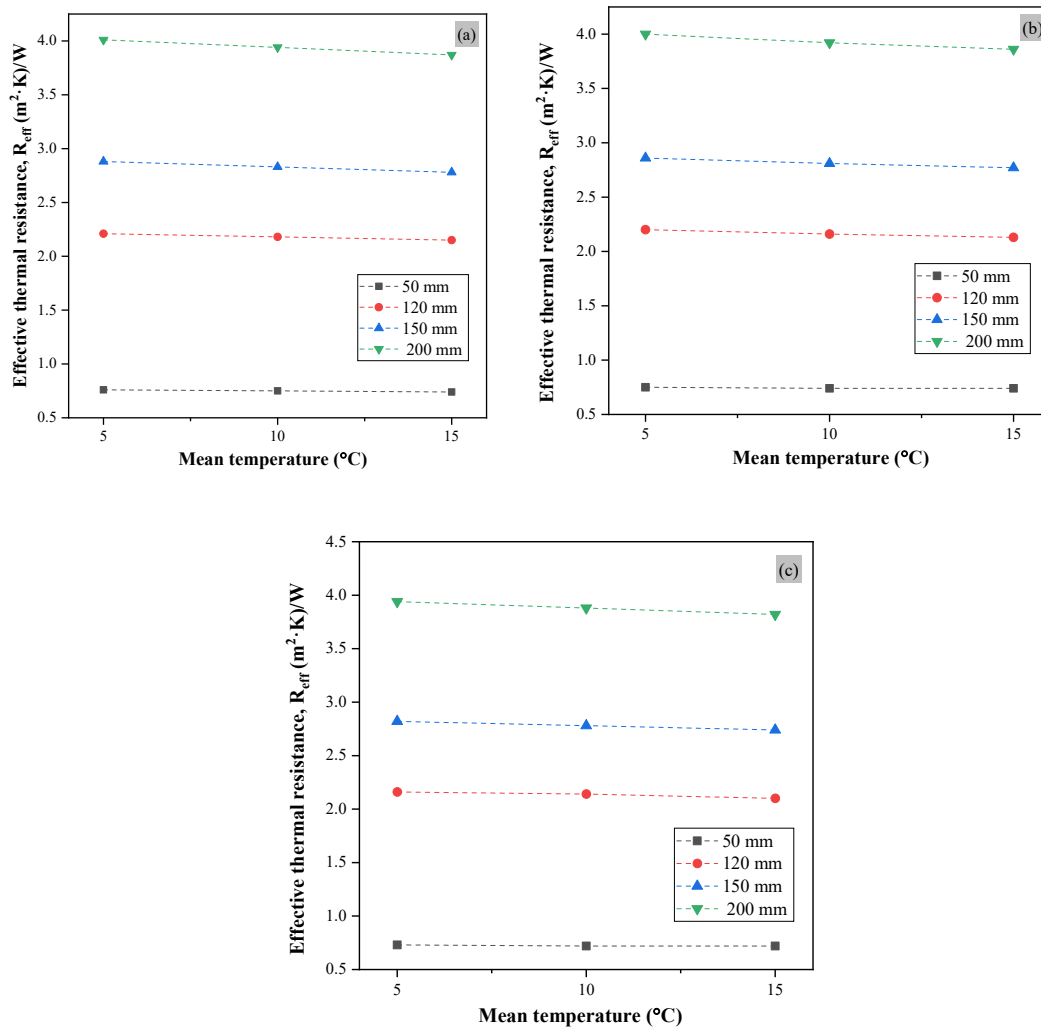

Figure 3.18 Changes in the values of the effective thermal resistance regarding the variations of mean temperature and thickness at different relative humidity levels: **(a)** 33%RH; **(b)** 57%RH; **(c)** 75%RH.

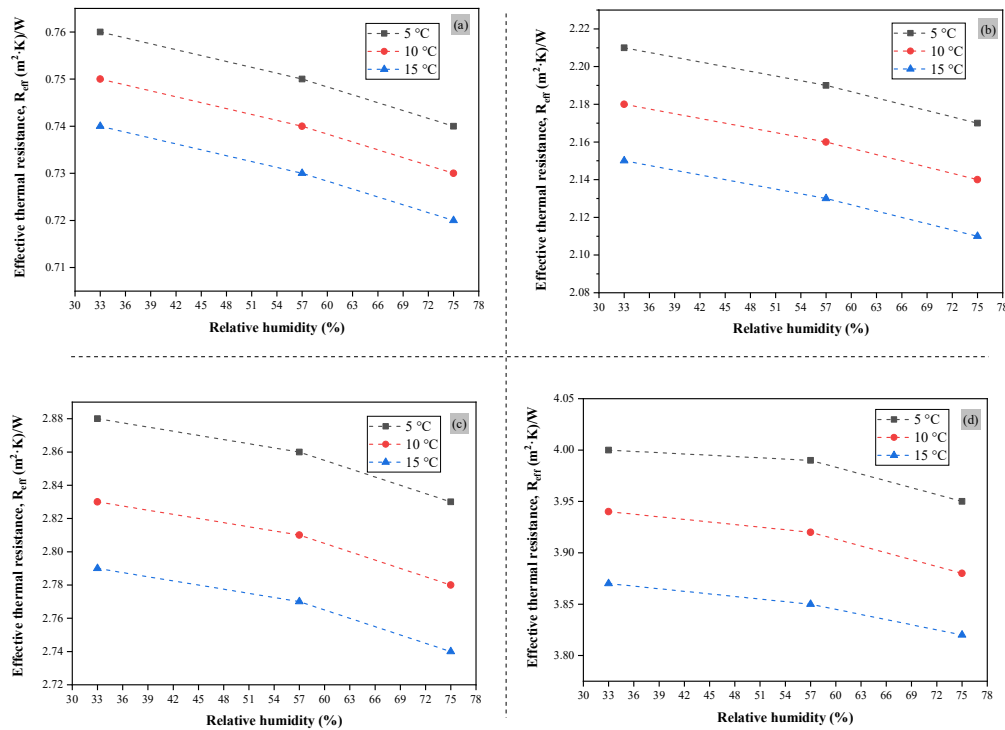

Figure 3.19 Changes in the values of the effective thermal resistance regarding the variations of relative humidity and temperature at different thicknesses: **(a)** 50 mm; **(b)** 120 mm; **(c)** 150 mm; **(d)** 200 mm.

For a multi-layered insulation material, thermal properties are expressed by thermal transmittance coefficient (U-value) which is the heat flow that passes through a unit area of a complex component or inhomogeneous material due to a temperature gradient equal to 1K and this value refers to how well an element conducts heat from one side to another side. As it defined, the low U-value indicates a high level of insulation capacity. Fig. 3.20 illustrates the thermal transmittance values at different thicknesses of the cellulose fiberboard insulation layer regarding the variations of temperature and relative humidity levels. As seen in the graph, the U-value decreased when the thickness increased from 50 to 200 mm. The high U-value was found of $1.38 \text{ W}/(m^2 \cdot K)$ at the thickness of 50 mm due to the high transferred heat caused by the significant influence of heat and moisture flux at high temperature (15 °C) and high relative humidity (75%RH), followed by the U-value at approximately $1.36 \text{ W}/(m^2 \cdot K)$ and $1.34 \text{ W}/(m^2 \cdot K)$ at the same thickness and the same mean temperature but lower relative humidity levels (57% and 33%RH, respectively). The lowest U-value was around $0.26 \text{ W}/(m^2 \cdot K)$ at the thickness of 200 mm resulting from the low effect of temperature and relative humidity (at a mean temperature of 5 °C and 33%RH). However, the U-value was still higher at higher relative

humidity. Besides, the U-value showed a slight increase as the relative humidity increased from 33 to 75% for all temperatures and thicknesses demonstrating the strong impact of the moisture flux caused by the water vapor pressure from the outdoor air in the heat transfer through the insulation materials. An experimental result was found having the similar changes in the U-value related to the thickness. In this study, the multi-layered wall solution had the similar layers but the rice straw bale material was used as the core insulation layer in order oriented strand board, rice straw bale board, oriented strand board and the thickness of straw bale insulator increased from 200 to 500 mm [156]. According to the results, the total U-value decreased to lower than $0.1 \text{ W/m}^2\cdot\text{K}$ when the thickness increased to 500 mm and the value at the thickness of 200 mm was similar to the results attained from the present simulation. Accordingly, the defined model in this simulation has shown an appropriate approach to numerically solve the dependence of thermal performance on the thickness of insulation materials.

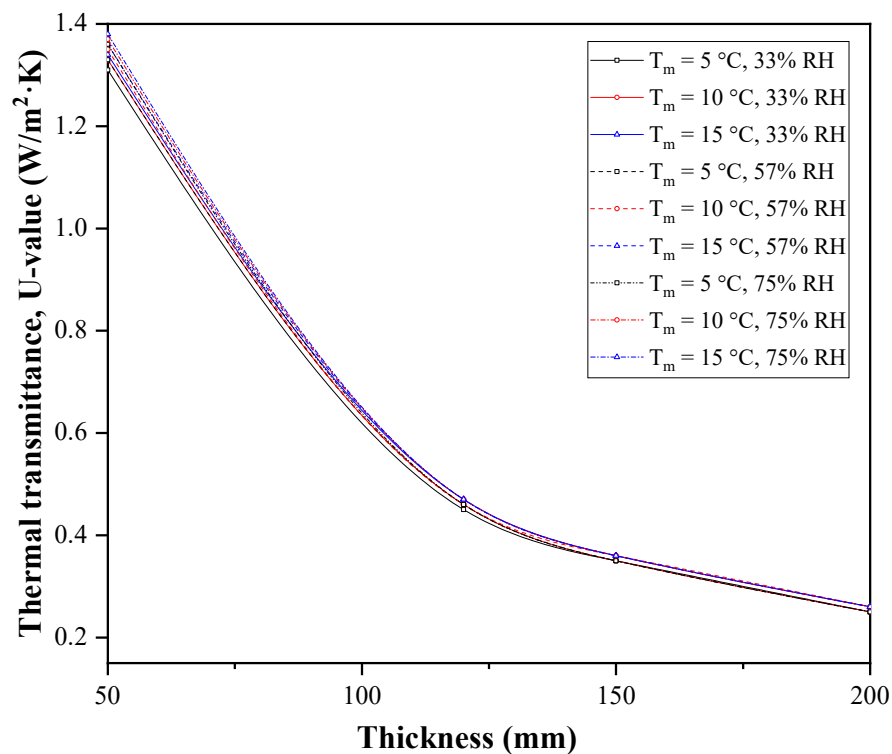

Figure 3.20 Changes in the thermal transmittance coefficient regarding the increase in thickness of insulation layer and variations of temperature and relative humidity.

The next figure illustrates the moisture content and the moisture storage capacity of the multi-layered insulation materials regarding the variations of mean temperature and relative humidity in the range of 33–75% at the 50 mm thickness of cellulose fiberboard insulation layer. The moisture content characterizes the relationship between the amount of accumulated water and the relative humidity in the material while the moisture storage capacity refers to the maximum water absorption when exposed to humid air and it is defined as the ratio of the weight of water absorbed by a material in the saturated state over the weight of the dry material [174]. There was an increase in the moisture content levels and the moisture storage capacity as the relative humidity increased at the same mean temperature. However, a slight decrease in the moisture content was found when the temperature increased from 5 to 15 °C for all levels of relative humidity. Specifically, the percentages of moisture content at 33%RH decreased from 14.39% to 14.32% and from 21.76% to 21.64% at 57%RH while the decreased values at 75%RH were from 29.53% to 29.39% as the mean temperature increased from 5 °C to 15 °C. This result was in contradiction with the fact that the higher the temperature, the higher the holding moisture capacity. It might come from the assumption that the density and specific heat capacity did not change when the temperature and relative humidity changed, thereby influencing the actual thermal diffusivity and water diffusion. This could be an improvement that needs to be considered to modify the model in the future work.

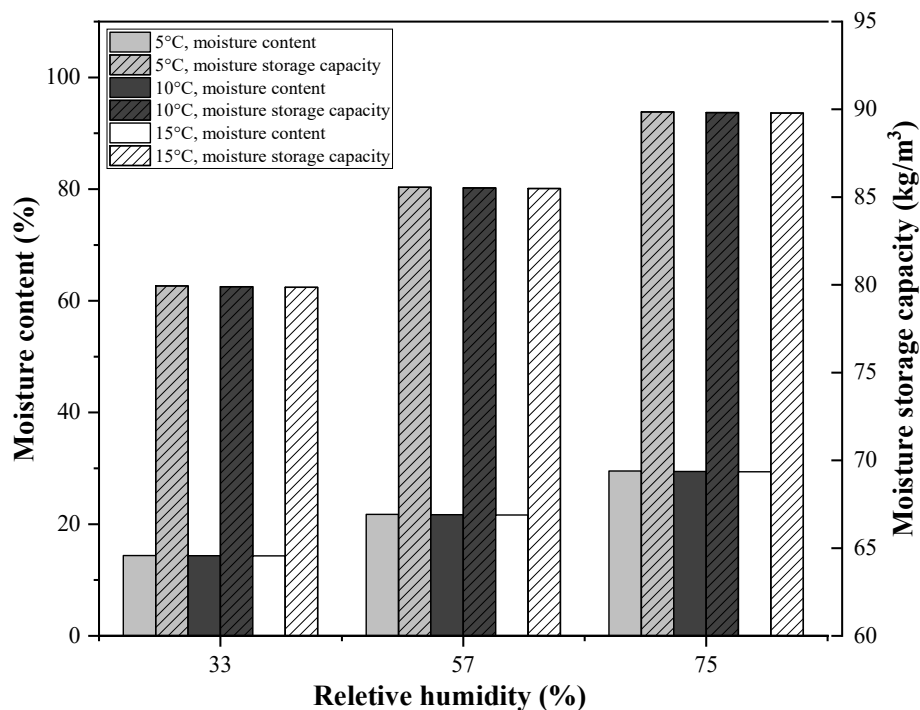

Figure 3.21 Changes in moisture content and moisture storage capacity regarding the variations of temperature, relative humidity at the 50 mm thickness of cellulose fiberboard.

3.8.2. Heat and moisture transfer through the multi-layered insulation materials in dynamic boundary conditions

As described in the section 2.3.8, the multi-layered insulation materials was performed as three layers in order OSB-CFB-OSB and their materials properties were imported from the library of the COMSOL Multiphysics program. The research conditions used for analyzing the effective thermal conductivities (λ_{eff}) and the moisture content of the insulation materials caused by temperature and moisture migration are as follows: the temperature and the relative humidity of the indoor air are remained at the most favorable levels which were 20 °C and 50%, respectively. The temperature and the relative humidity of the outdoor air change dynamically and data was imported from the ASHARE 2017 (from the library of the COMSOL).

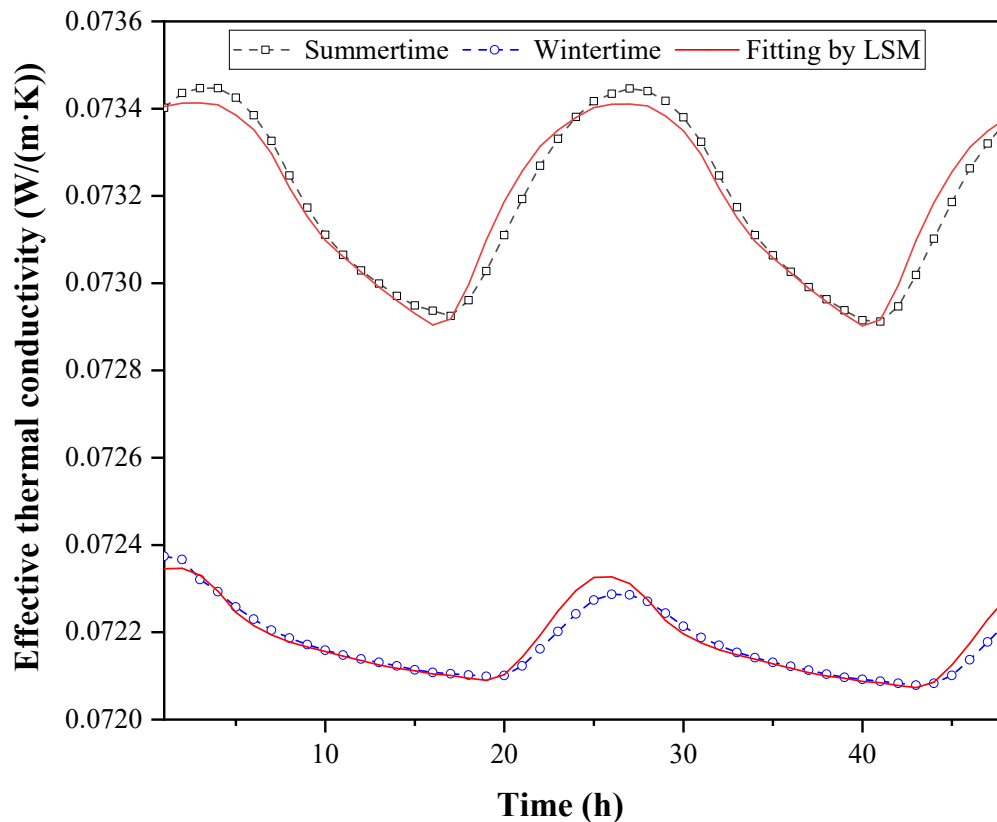

Figure 3.22 The effective thermal conductivity variations regarding the ambient temperature and relative humidity for 2 days in summertime and wintertime and their fitting by LSM.

The changes in the effective thermal conductivity of the multi-layered insulation materials at the 50 mm thickness of the cellulose fiberboard layer under the variations of ambient temperature and ambient relative humidity in the summertime and wintertime for 2 days are shown in Fig. 3.22. The average values of the effective thermal conductivity were 0.0732 W/(m·K) and 0.0722 W/(m·K) for summertime and wintertime, respectively. As is seen from the graph, the variations of the λ_{eff} in summer conditions showed a larger difference than the variations of the λ_{eff} in winter conditions. It can be explained by the great influence of the heat and moisture flux caused by the large difference between the indoor and the ambient temperature as well as relative humidity of the outdoors (see Fig. 3.23 and 3.24). Especially, the high amplitude of moisture flux caused by moisture migration in the summer season had a significant effect on heat flux fluctuation, which was totally reflected in the value and phase change of the heat flux in the summer season compared to the results in the winter season which had no change in the phase of heat flux. In addition, the high temperature in summertime was always related to the more water vapor a volume of air is capable of holding, and the thermal conductivity of water was higher than that of the dry air. As a result, the ETCs in the summertime had been remarkably influenced by the heat and moisture flux while there was only the moisture flux contributed to the increase of ETCs in the wintertime. On the other hand, when the temperature and humidity of the indoor air were constant, it can be concluded that the water vapor pressure of the outdoor air had a significant effect on the amplitude of the moisture flux through the external surface, while the amplitude of the moisture flux through the internal surface was mainly affected by the outdoor air temperature, as it was reported in the study [175]. A similar investigation on the thermal conductivity as a variable of the coupled heat and moisture transfer on the multi-layered wall structure was done [176]. In this study, five types of insulation materials including EPS, XPS, glass wool, phenolic resin, and rock wool used as the middle layer and their thermal conductivity was also evaluated regarding the changes of ambient temperature and humidity in the summer and winter conditions by numerical simulation.

The simulation results indicated the general trend of the effective thermal conductivity was associated with the variations of ambient temperature and relative humidity. That is, as outdoor temperature and relative humidity increase or decrease, they will affect the heat and moisture flux across the insulation materials leading to respective changes in the effective thermal conductivity. Therefore, the λ_{eff} variation may satisfy the general empirical relationship as given in Eq. (3.1)

$$\lambda = a + bT + c\phi \quad (3.1)$$

Using the Method of Least Squares, the constants were determined and the resulting equations are as follows (the fitting curves were presented in Fig. 3.19):

In the summer condition: $\lambda = 0.071604 - 0.000111T - 0.001634\phi$

In the winter condition: $\lambda = 0.071304 + 0.000111T + 0.000694\phi$

In general, the influence of ambient temperature and humidity on the thermal conductivity of fiber insulation materials should not be underestimated. Whether the material has a tight structure or open/closed pores, it will be affected by the humidity of surroundings. It can be concluded that setting the fixed value of the thermal conductivity causes large errors in the calculation of the cooling and heating load and the estimation of energy consumption of the actual building, especially in areas with high humidity.

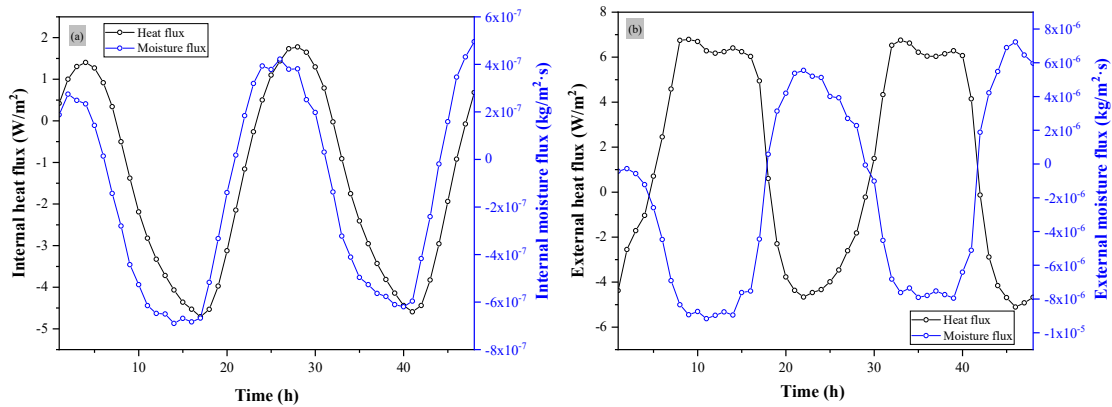

Figure 3.23 Variations of heat and moisture flux through (a) internal; (b) external surfaces in summertime.

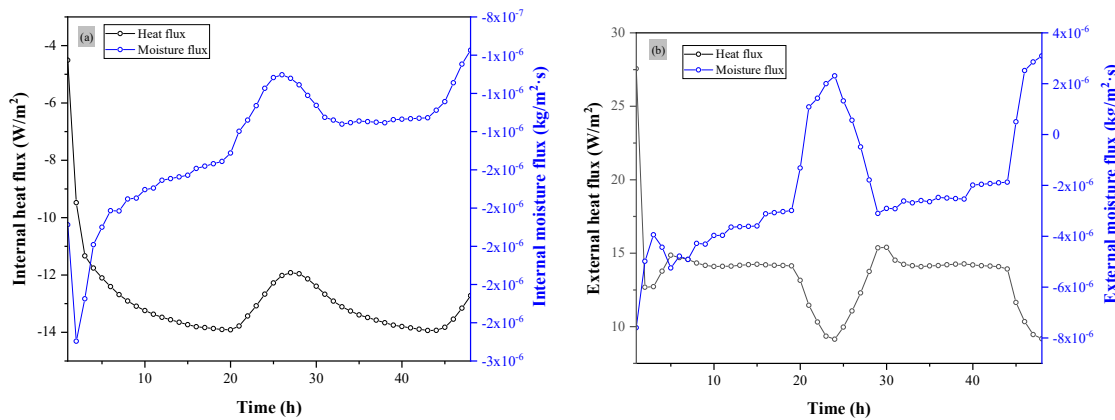

Figure 3.24 Variations of heat and moisture flux through (a) internal; (b) external surfaces in wintertime.

Moisture has effects on several factors used indoor environments, for example, on mean radiant temperature by changing the effective thermal conductivity of the multi-layered insulation structure, or on the indoor humidity by changing the indoor air quality. If moisture diffuses from the structures, it may result in surface condensation in case the temperature of the surface is below the dew point temperature of humidity. Thus, the following results can be beneficial for investigating the risk of condensation occurring in the cellulose fiber insulation materials. Fig. 3.25 reveals the changes in the moisture content of multi-layered insulation materials at the 50 mm thickness of the cellulose fiberboard regarding the variations of ambient relative humidity in the summer and winter seasons simulated for 2 days. The aim of this study is to study the hygroscopic behaviour of cellulose fiber-based materials and to obtain a better understanding of the thermal performance of the multi-layered insulation materials during the moisture absorption process and different temperature distribution. As the moisture content represents the amount of water accumulated in insulation materials and their significant influence on the thermal characteristics, therefore, these results help to determine the risk of condensation caused by the moisture migration on the cellulose fiber of insulation materials. It is observed that the changes in moisture content percentages were notably dependent on the moisture flux through the surfaces of insulation materials and showed a similar trend for both summertime and wintertime (see Fig. 3.23 and 3.24). Resembling with the variations of the effective thermal conductivity, the moisture content was significantly influenced by both heat and moisture transfer in the summertime, whereas, the variations in the wintertime were mainly from the contribution of moisture flux.

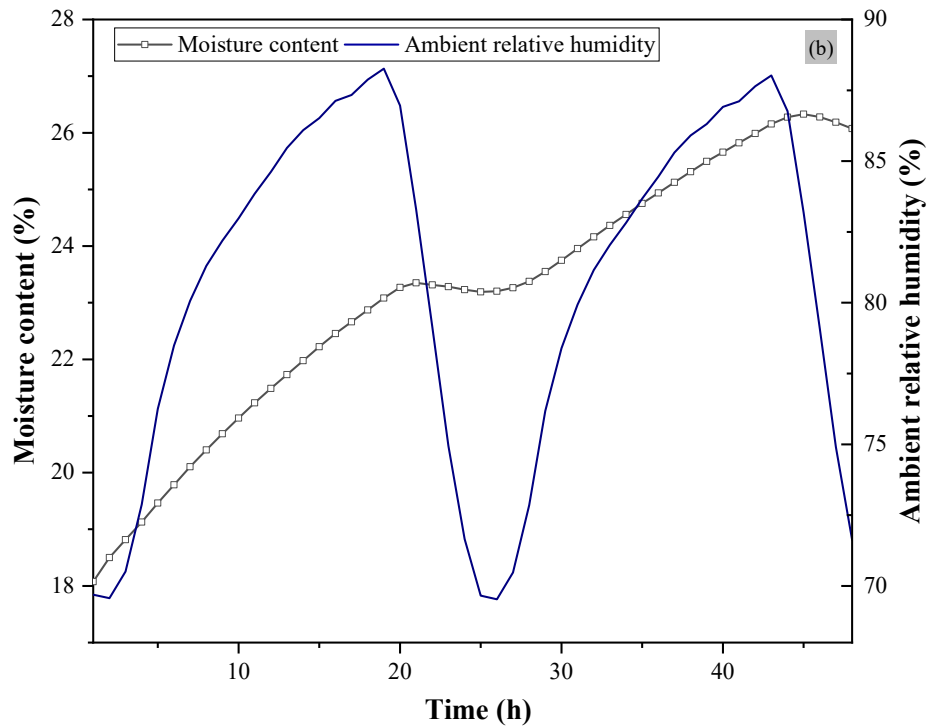
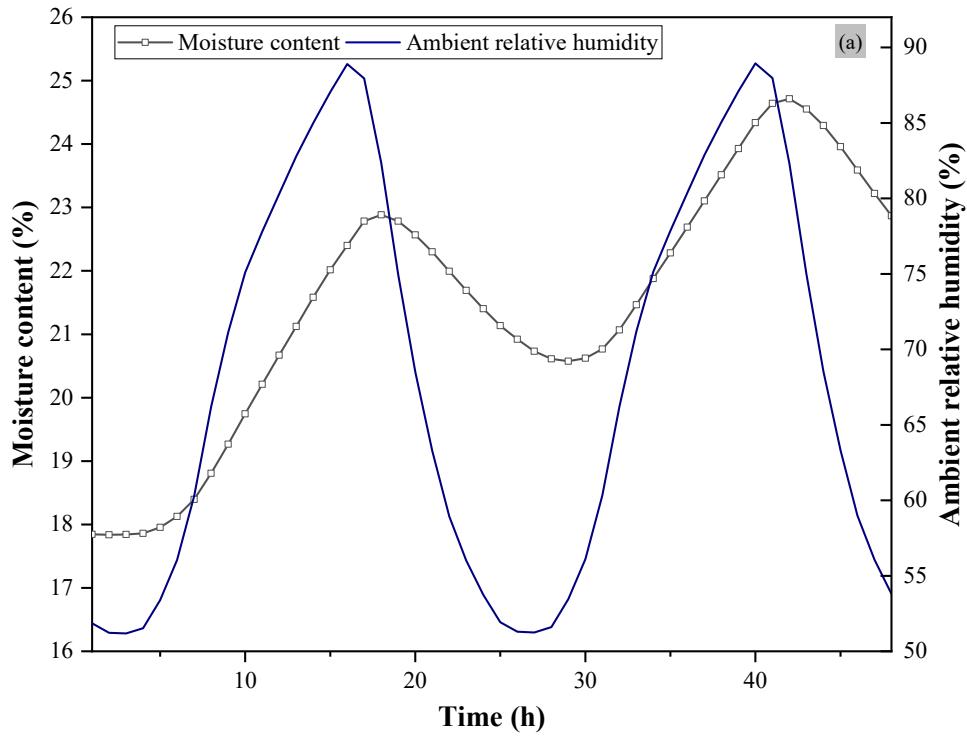

Figure 3.25 Changes in moisture content regarding the ambient relative humidity: **(a)** summertime; **(b)** wintertime.

Some scholars have studied the effect of thermal conductivity of temperature varied insulation materials on building energy consumption by taking into account only heat transfer [100]. However, building envelopes are exposed to the temperature and humidity changes of the external environment for a long time in actual engineering applications, especially in extremely hot and humid areas. When studying the heat flow of building envelopes in extremely hot and humid areas, the thermal conductivity of insulation materials should be considered on the basis of changes in temperature and humidity, and the coupled heat and moisture transfer process of the wall should be considered to restore the actual heat flow of building walls to a greater extent. This has guiding significance for the selection of building wall insulation materials and the analysis of actual wall heat flow in extreme hot and humid areas. At present, there are little few studies on the influence effect of the coupled heat and moisture transfer on the multi-layered insulation materials when the thermal properties change with ambient temperature and ambient relative humidity. Therefore, these numerical simulations could be an effective approach for the further experimental investigation in the thermal performance of the multi-layered insulation materials used in buildings.

3.9 Summary

In this chapter, the thermal conductivity values of insulation materials based on natural fiber were measured and discussed. The thermal conductivity values of binderless fiber insulation boards were found ranging from 0.04 to 0.055 W/(m·K) demonstrating the potentiality to be used as a prominent insulation material for building applications. Besides, the thermal conductivity values of polymer composites reinforced with coir fiber, rice straw and energy reed fiber were also examined and despite the values were relatively high (from 0.06 to 0.1 W/(m·K)) but they also showed a better thermal insulation property. The influence of temperature and relative humidity in the thermal conductivity values was also examined and their relationship was fitted by possible function with a high coefficient of determination showing a strong impact of the factors on the thermal characteristics of insulation materials meaning that these factors could not be neglected in any experimental investigation of thermal properties of insulation materials. In addition, the water absorption of natural fiber based insulation boards was also explored to examine the changes in moisture content regarding the variations of relative humidity levels. This study was found to give a better understanding of the hygroscopic behaviour of natural fibrous insulation materials.

The heat and moisture transfer through the multi-layered insulation materials under the variations of ambient temperature and relative humidity in the static and dynamic boundary

conditions were also numerically calculated to investigate the thermal effectiveness, the moisture content, and the risk of condensation caused by the moisture migration. Accordingly, the proposed model has shown the appropriate results compared to some published practical study. Therefore, the numerical simulation could be a good combination with the practical investigation of the thermal performance of the multi-layered insulation materials made of cellulose fiber.

CHAPTER IV: CONCLUSIONS AND FUTURE WORKS

The research work has been summarized in the following points that indicate the achievements as well as implications.

- The new insulation materials made from sugarcane bagasse fiber were manufactured without the addition of binders. The binderless bagasse insulation boards recorded a low value of density and thermal conductivity demonstrating that they can be used as a prominent thermal insulation material for sustainable building applications.

- The coefficient of thermal conductivity of natural fibrous insulation materials and composites made of plant-based materials was examined regarding temperature and relative humidity variations. According to the experimental results, thermal conductivity values were reported at approximately 0.04 to 0.1 W/(m·K) proving a better thermal insulation quality compared to other bio-based composites made of synthetic fiber.

- For the water absorption test, the methods of using the climatic chamber and the desiccator were conducted. It is highlighted that higher relative humidity levels always reported higher water absorption. The water absorption isotherm was found to give a better understanding of the hygroscopic behaviour contributing to the improvement of hygrothermal and durability performance of natural fibrous insulation materials over time.

- The dependence of the thermal conductivity coefficient on temperature and moisture content was investigated practically. The relationship was analyzed by fitting an appropriate regression with a high coefficient of determination. As a result, the highest values of thermal conductivity were always recorded at the highest temperature and humidity demonstrating that higher temperature and relative humidity are always associated with higher heat conductance.

- Heat and moisture transfer in multi-layered insulation materials under the ambient temperature and relative humidity variations in static and dynamic boundary conditions were numerically investigated. Based on the results, the proposed model, assumptions, and boundary conditions showed high reliability so that it can be used for future work in the case of different insulation materials and properties. However, as concluded in the discussion, it is needed to modify the density and specific heat capacity since they are also influenced by the temperature and relative humidity changes.

- Overall, this research work figured out a potentiality for the directions of future research for binderless thermal insulation materials made of plant-based resources and multi-layered insulation materials for building applications.

The present research work demonstrated a successful investigation of the thermal insulation materials made of natural fiber, their thermal conductivity values, and the

relationship between the thermal conductivity coefficient and temperature, moisture content, and apparent density. This methodology could be extended in various sectors as follows:

- The influence of airflow velocity in heat transfer through insulation materials as well as the calculation includes the heat convective conductance using the differential thermal chamber.
- The binderless thermal insulation materials made of other natural fibers, their mechanical properties and thermal insulation quality.
- Practical investigation on heat and moisture transfer in multi-layered insulation materials as proposed model in the simulation study.

CHAPTER V: NOVEL FINDINGS OF THE RESEARCH

Theses 1: Factors influencing thermal conductivity of insulation materials

The comprehensive review presents general findings on the factors influencing the thermal conductivity of insulation materials commonly used for buildings. The main factors including temperature, moisture content, and density affecting thermal conductivity values were presented and their relationships were interpreted in detail for each type of insulation material. Other factors affecting the thermal performance were also reported, namely thickness, airflow velocity, pressure and aging time. This literature review has contributed to the general research on the thermal conductivity of insulation materials in the construction sector at a building level.

Theses 2: Developing a new thermal insulation material from sugarcane bagasse

The new thermal insulation material was developed from sugarcane bagasse fiber without using binders or additives. By not using synthetic adhesive, the resin coating process and curing period can be omitted, which leads to reduction in cost and energy, hazardous effects on human health and the environmental burden imposed by disposal or recycling of the fiberboard. Novel finding is that the binderless bagasse fiberboards displayed low values of density (85–135 kg/m³) and thermal conductivity (from 0.0435 W/(m·K) to 0.0530 W/(m·K)). As a result, these novel insulation materials showed better thermal insulation qualities compared to other polymer biocomposites.

Theses 3: Water absorption of natural fiber insulation materials regarding the absorbent time

The aim of this research was to examine the minimum time for the equilibrium state of binderless bagasse insulation materials to be obtained. According to the practical examination of water absorption of the binderless bagasse fiber insulation board at a thickness of 25 mm, the equilibrium state using the desiccator method needed a duration of 28–35 days to be achieved. It is also showed that samples followed typical Fickian diffusion behaviours in that water absorption occurs rapidly at the beginning time of exposure with water (7–14d), then, after time, the absorption rate slows down until reaching the point of equilibrium. The cause of higher water absorption was due to the presence of some hydrophilic compounds in the natural fibrous structures which were detected in terms of transmittance of FTIR spectra measurement and because of the weak bonding of the fiber and matrix interfaces as well as the gaps on the surface leading to the high absorption of water.

Theses 4: Water absorption of binderless natural fiber-based insulation material related to relative humidity levels

Due to the hydrophilic nature of cellulose fiber, it is essential to investigate water absorption depending on relative humidity. The water absorption percentages of the binderless coir fiber insulation board (BCIB) and binderless bagasse fiber insulation board (BBIB) were conducted at different humidity levels. As a result, the tested samples showed a similar sorption behaviour, and they exhibited a typical behaviour of natural fibers with a high increase of moisture content above the relative humidity of 75%. The values of water absorbency for the BCIB were from 7.66% at 16%RH to the maximum value of 23.54% at 90%RH and the values of BBIB were found of 10.5–17.33% in the range of 33–96%RH. Consequently, higher water absorption is always associated with higher relative humidity levels, and the moisture sorption isotherm expressed from the experimental data has proved the efficacy of the methods used in this study.

Theses 5: Temperature dependence of thermal conductivity

The temperature-dependent thermal conductivity of natural fiber insulation materials was experimentally examined. It is shown that higher temperatures always recorded higher thermal conductivity values for all tested specimens. The thermal conductivity of the binderless bagasse fiber insulation boards (BBIB) increased markedly from 0.041 W/(m·K) to 0.057 W/(m·K) while the thermal conductivity of the binderless coir fiber insulation boards increased from 0.037 W/(m·K) to 0.066 W/(m·K) as the operating temperature increased from -10 °C to 50 °C. The percentage rate of changes in the values of thermal conductivity of BBIB was found of 16–20% demonstrating a lower heat consumption than that of other bio-based products (usually in the range of 20–30%) or wood-based fiberboards (typically up to 50%). The linear functions were found to express the strong influence of temperature in the changes in the thermal conductivity coefficient with a high value of the coefficient of determination. According to the results, the obtained thermal conductivity values at different temperatures are found to provide comparatively better thermal insulation capacity showing that these binderless insulation boards could perform as prominent building insulation materials.

Theses 6: Relative humidity dependence of thermal conductivity

Based on the practical examination of the influence of relative humidity in the thermal conductivity values of binderless coir fiber insulation boards (BCIB) and binderless bagasse fiber insulation boards (BBIB), an increasing tendency was reported for all tested specimens in

that increased relative humidity led to the increase in thermal conductance. Accordingly, the thermal conductivity values of three samples of BCIB were recorded in the range of 0.049–0.066 W/(m·K), 0.058–0.094 W/(m·K), and 0.069–0.107 W/(m·K) regarding the humidity range of 16.5–90%. Whereas, the values of thermal conductivity of three tested specimens of BBIB were found of 0.044–0.049 W/(m·K), 0.046–0.052 W/(m·K), 0.058–0.069 W/(m·K) when the relative humidity increased from 33 to 96%. The high thermal conductivity of natural fibrous insulation materials is mainly caused by the presence of a high number of water absorbed in the cellulose fiber base structure.

Theses 7: Numerical simulation of heat and moisture transfer in multi-layered insulation material

Based on the numerical calculation from the simulation study of heat and moisture transfer in multi-layered insulation materials using the cellulose fiberboard as a core layer, the values of effective thermal conductivity (ETCs) recorded a slight increase in the range of 0.0499–0.0691 W/(m·K) since the temperature ranged from 5 to 15 °C and the humidity increased from 33 to 75%. The higher temperature and higher humidity always revealed a higher value of thermal conductivity, and a similar increasing trend was found for all simulated cases. Results also showed that changes in the thermal transmittance coefficient are always ascribed to the thickness of the cellulose fiberboard. Accordingly, the U-value decreased from 1.38 W/(m²·K) at the thickness of 50 mm to 0.26 W/(m²·K) at the 200 mm thickness showing that the 50–200 mm thickness could be considered as the critical thickness in designing the multi-layered insulation materials to meet the requirements of nearly zero-energy building. For the simulation study in the dynamic boundary conditions in that the outside temperature and relative humidity change dynamically for 2 days, the effective thermal conductivity in summer conditions showed a higher value than that in winter conditions due to the great influence of the heat and moisture flux caused by the large difference between the indoor and the ambient temperature as well as the relative humidity of the outdoors. As a result, the ETCs in the summertime have been remarkably influenced by the heat and moisture flux while there was only the moisture flux contributed to the increase of ETCs in the wintertime. The relative humidity-dependent moisture content over time also showed similar behaviour with the ETCs in that it was significantly influenced by both heat and moisture transfer in the summertime while the variations in the wintertime were mainly from the contribution of moisture flux.

List of publications

Journal articles (published)

[6] **D. H. A. Le** and Z. Pásztor (2023). Experimental Study of Thermal Resistance Values of Natural Fiber Insulating Materials under Different Mean Temperatures. South-east Eur for 11 (1): early view. (<https://doi.org/10.15177/see-for.23-03>)

[5] **Le Duong Hung Anh**, Pásztor Zoltán, Experimental Investigation of Thermal Conductivity Values and Density Dependence of Insulation Materials from Coir Fiber, International Journal of Materials Science and Engineering, Vol. 10, No. 4, pp. 71-79, November 2022. (<https://doi.org/10.17706/ijmse.2022.10.4.71-79>)

[4] **D. H. A. Le** and Z. Pásztor (2021), An Overview of Factors Influencing Thermal Conductivity of Building Insulation Materials. Journal of Building Engineering, Vol. 44, 102604. (<https://doi.org/10.1016/j.jobee.2021.102604>)

[3] S. Srivaro, Z. Pásztor, **H. A. Le Duong**, H. Lim, S. Jantawee, and J. Tomad (2021) Physical, mechanical and thermal properties of cross laminated timber made with coconut wood. European Journal of Wood and Wood Products, 0018-3768 1436-736X, 1-11. (<https://doi.org/10.1007/s00107-021-01741-y>)

[2] K. M. F. Hasan, P. G. Horváth, M. Bak, **D. H. A. Le**, Z. M. Mucsi, and T. Alpár (2021) Rice straw and energy reed fibers reinforced phenol formaldehyde resin polymeric biocomposites. Cellulose, Vol. 28, no. 12, 7859-7875. (<https://doi.org/10.1007/s10570-021-04029-9>)

[1] Hasan, K. M., Horváth, P. G., Kóczán, Z., **Le, D. H. A.**, Bak, M., Bejő, L., & Alpár, T. (2021). Novel insulation panels development from multilayered coir short and long fiber reinforced phenol formaldehyde polymeric biocomposites. Journal of Polymer Research, 28(12), 1-16. (<https://doi.org/10.1007/s10965-021-02818-1>)

Journal articles (submitted)

[1] **D. H. A. Le**, Z. Kóczán, Z. Börcsök, and Z. Pásztor (2023). Development of new insulation material from sugarcane bagasse and examination of the insulation effect depending on temperature and humidity.

Conference paper

[8] **D. H. A. Le** and Z. Pásztor (2023). Numerical simulation of the influence of air space thickness in heat transfer of a high-performance glazing system. 2023 9th International Conference on Environment and Renewable Energy, 24-26 February 2023, Hanoi University of Science and Technology, Ha Noi, Viet Nam.

[7] **D. H. A. Le** and Z. Pásztor (2022). Experimental Study of Thermal Resistance Values of Natural Fiber Insulating Materials under Different Mean Temperatures. GREEN 2022/4, University of Zagreb, 14-16 September 2022, Zagreb, Croatia.

[6] K. M. Faridul Hasan, **Le Duong Hung Anh**, Horváth Péter György, Bak Miklós, Tibor Alpár (2022). Green Insulation Panels Development from Industrial Lignocellulosic Materials Reinforced Cementitious Composites. 5th International Conference on Building Energy and Environment (COBEE 2022). Montreal, Canada, July 26, 2022.

[5] Z. M. Mucsi, K. M. F. Hasan, **D. H. A. Le**, P. G. Horváth and T. Alpár (2022). Methylene Diphenyl Diisocyanate and Dement-bonded Insulation Panels Reinforced with Coconut fiber and Energy Reed Straw Mediated by Semi-dry Technology. XXV. SPRING WIND CONFERENCE, Pécs, Hungary.

[4] **D. H. A. Le** and Z. Pásztor (2022). Experimental investigation of thermal conductivity values and density dependence of insulation materials from coir fiber. 2022 8th International Conference on Environment and Renewable Energy, 24-26 February 2022, Hanoi University of Science and Technology, Ha Noi, Viet Nam.

[3] **D. H. A. Le** and Z. Pásztor (2021) Experimental investigation of the influence of temperature on the thermal conductivity of raw coconut fiber. IV. International scientific and practical conference “ACTUAL PROBLEMS AND DEVELOPMENT PROSPECTS OF FOREST INDUSTRY COMPLEX”, September 8-11, Kostroma State University, Kostroma, Russia, 2021, pp. 34-38.

[2] **D. H. A. Le** and Z. Pásztor (2021). Investigation of the influence of temperature and moisture content on the thermal conductivity of raw coconut fibers. XXIV. Tavaszi Szél Konferencia, Miskolc, Hungary, 157-167, Miskolci Egyetem.

[1] **D. H. A. Le** and Z. Pásztor (2020) Review of the effect of moisture content on the thermal conductivity of natural fiber insulating materials. MISKOLC IPW - IV. SUSTAINABLE RAW MATERIALS INTERNATIONAL PROJECT WEEK, Miskolc, 141-145, Hungary: Institute of Raw Material Preparation and Process Engineering, University of Miskolc.

Book chapter

[1] **D. H. A. Le** and Z. Pásztor (2023). Natural Fiber Reinforced Vinyl Ester Composites Influence of Moisture Absorption on the Physical, Thermal and Mechanical Properties. Vinyl Ester based Biocomposites, CRC Press, Taylor & Francis Group. (Volume 2; ISBN: 978-1-032-22048-2).

References

- [1] Lemmet, S.: Buildings and Climate Change. Summary for Decision-Makers. UNEP SBCI, 2009. pp.
- [2] USEIA, E. *International Energy Outlook 2018 - Highlights*. 2018; Available from: https://www.eia.gov/pressroom/presentations/capuano_07242018.pdf.
- [3] Olivier, J., K. Schure, and J. Peters. Trends in global CO₂ and total greenhouse gas emissions: Summary of the 2017 report. PBL Netherlands Environmental Assessment Agency: The Hague, The Netherlands, 2017. pp.
- [4] Solomon, S.: IPCC (2007): Climate change the physical science basis. AGUFGM, 2007, 2007. pp. U43D-01.
- [5] Pachauri, R. and A. Reisinger. Climate change 2007. Synthesis report. Contribution of Working Groups I, II and III to the fourth assessment report. Cambridge University Press, Cambridge, 2008. pp.
- [6] Handbook-Fundamentals, A., *American Society of Heating, Refrigerating and Air*. 2001, Conditioning Engineers Publishers, Inc., Atlanta, GA, USA.
- [7] Al-Homoud, M.S.: Performance characteristics and practical applications of common building thermal insulation materials. *Building and environment*, 40(3), 2005. pp. 353-366.
- [8] Zhang, H., et al.: Experimental study of the thermal conductivity of polyurethane foams. *Applied Thermal Engineering*, 115, 2017. pp. 528-538.
- [9] Walker, R. and S. Pavia. Thermal performance of a selection of insulation materials suitable for historic buildings. *Building and environment*, 94, 2015. pp. 155-165.
- [10] Aditya, L., et al.: A review on insulation materials for energy conservation in buildings. *Renewable and sustainable energy reviews*, 73, 2017. pp. 1352-1365.
- [11] Villasmil, W., L.J. Fischer, and J. Worlitschek. A review and evaluation of thermal insulation materials and methods for thermal energy storage systems. *Renewable and Sustainable Energy Reviews*, 103, 2019. pp. 71-84.
- [12] Abu-Jdayil, B., et al.: Traditional, state-of-the-art and renewable thermal building insulation materials: An overview. *Construction and Building Materials*, 214, 2019. pp. 709-735.
- [13] D'Alessandro, F., et al.: Insulation materials for the building sector: A review and comparative analysis. *Renewable and Sustainable Energy Reviews*, 62, 2016. pp. 988-1011.
- [14] Jelle, B.P.: Traditional, state-of-the-art and future thermal building insulation materials and solutions—Properties, requirements and possibilities. *Energy and Buildings*, 43(10), 2011. pp. 2549-2563.
- [15] Papadopoulos, A.M.: State of the art in thermal insulation materials and aims for future developments. *Energy and buildings*, 37(1), 2005. pp. 77-86.
- [16] Pfundstein, M., et al. *Insulating materials: principles, materials, applications*. Walter de Gruyter, 2012.
- [17] Zhang, H. *Building materials in civil engineering*. Elsevier, 2011.
- [18] Berardi, U. and M. Naldi. The impact of the temperature dependent thermal conductivity of insulating materials on the effective building envelope performance. *Energy and buildings*, 144, 2017. pp. 262-275.
- [19] Wu, J.-W., W.-F. Sung, and H.-S. Chu. Thermal conductivity of polyurethane foams. *International Journal of Heat and Mass Transfer*, 42(12), 1999. pp. 2211-2217.
- [20] Omer, S., S. Riffat, and G. Qiu. Thermal insulations for hot water cylinders: a review and a conceptual evaluation. *Building Services Engineering Research and Technology*, 28(3), 2007. pp. 275-293.

- [21] Panyakaew, S. and S. Fotios. New thermal insulation boards made from coconut husk and bagasse. *Energy and buildings*, 43(7), 2011. pp. 1732-1739.
- [22] Hoseini, A., et al.: Aerogel blankets: From mathematical modeling to material characterization and experimental analysis. *International Journal of Heat and Mass Transfer*, 93, 2016. pp. 1124-1131.
- [23] Domínguez-Muñoz, F., et al.: Uncertainty in the thermal conductivity of insulation materials. *Energy and Buildings*, 42(11), 2010. pp. 2159-2168.
- [24] Bakatovich, A. and F. Gaspar. Composite material for thermal insulation based on moss raw material. *Construction and Building Materials*, 228, 2019. pp. 116699.
- [25] Nguong, C., S. Lee, and D. Sujan. A review on natural fibre reinforced polymer composites. *International Journal of Materials and Metallurgical Engineering*, 7(1), 2013. pp. 52-59.
- [26] Milanese, A.C., M.O.H. Cioffi, and H.J.C. Voorwald. Mechanical behavior of natural fiber composites. *Procedia Engineering*, 10, 2011. pp. 2022-2027.
- [27] Mehta, G., et al.: Effect of novel sizing on the mechanical and morphological characteristics of natural fiber reinforced unsaturated polyester resin based bio-composites. *Journal of materials science*, 39(8), 2004. pp. 2961-2964.
- [28] C168, A.S.: Terminology relating to thermal insulating materials. 2013. pp.
- [29] Standardization, E.C.f., *Thermal performance of building materials and products - Determination of thermal resistance by means of guarded hot plate and heat flow meter methods - Dry and moist products of medium and low thermal resistance*. 2001.
- [30] Standardization, E.C.f., *Thermal performance of building materials and products - Determination of thermal resistance by means of guarded hot plate and heat flow meter methods - Products of high and medium thermal resistance*. 2001.
- [31] Standardization, E.C.f., *Thermal performance of building materials and products - Determination of thermal resistance by means of guarded hot plate and heat flow meter methods - Thick products of high and medium thermal resistance*. 2000.
- [32] ASTM International, A.C.-. *Standard Test Method for Steady-State Thermal Transmission Properties by Means of the Heat Flow Meter Apparatus*.
- [33] ASTM International, A.C.-. *Standard Test Method for Steady-State Heat Flux Measurements and Thermal Transmission Properties by Means of the Guarded-Hot-Plate Apparatus*. pp.
- [34] N., Y.: The investigation of structure and operating parameters effect on the heat transfer coefficient in porous structures. Bursa: Uludag University, 2010. pp.
- [35] Yüksel, N., *The review of some commonly used methods and techniques to measure the thermal conductivity of insulation materials*, in *Insulation materials in context of sustainability*. 2016, IntechOpen.
- [36] Koru, M.: Determination of thermal conductivity of closed-cell insulation materials that depend on temperature and density. *Arabian Journal for Science and Engineering*, 41(11), 2016. pp. 4337-4346.
- [37] Čech, P., et al.: The quality of indoor air in wooden based buildings and the factors with impact of them. *Wood Research*, 61(4), 2016. pp. 583-598.
- [38] Khoukhi, M.: The combined effect of heat and moisture transfer dependent thermal conductivity of polystyrene insulation material: Impact on building energy performance. *Energy and Buildings*, 169, 2018. pp. 228-235.
- [39] ASTM, C.: 518, *Standard Test Method for Steady-State Thermal Transmission Properties by Means of the Heat Flow Meter Apparatus*. Annual Book of ASTM Standards, 2008. pp.
- [40] ISO, *Thermal insulation-Determination of steady-state thermal resistance and related properties-Heat flow meter apparatus*. 1991.

- [41] Abdou, A.A. and I.M. Budaiwi. Comparison of thermal conductivity measurements of building insulation materials under various operating temperatures. *Journal of building physics*, 29(2), 2005. pp. 171-184.
- [42] Khoukhi, M.: Simultaneous changes of temperature and moisture of thermal conductivity of EPS insulation material and its impact on building energy performance. *Int. J. Smart Grid Clean Energy*, 8(2), 2019. pp.
- [43] Shahedan, N.F., et al. *Review on thermal insulation performance in various type of concrete*. in *AIP Conference Proceedings*. 2017. AIP Publishing LLC.
- [44] Budaiwi, I., A. Abdou, and M. Al-Homoud. Variations of thermal conductivity of insulation materials under different operating temperatures: Impact on envelope-induced cooling load. *Journal of architectural engineering*, 8(4), 2002. pp. 125-132.
- [45] Abdou, A. and I. Budaiwi. The variation of thermal conductivity of fibrous insulation materials under different levels of moisture content. *Construction and Building materials*, 43, 2013. pp. 533-544.
- [46] Ochs, F. and H. Müller-Steinhagen. Temperature and moisture dependence of the thermal conductivity of insulation materials. NATO Advanced Study Institute on Thermal Energy Storage for Sustainable Energy Consumption (TESSEC), Izmir, Cesme, 2005. pp.
- [47] Berardi, U.: The impact of temperature dependency of the building insulation thermal conductivity in the Canadian climate. *Energy Procedia*, 132, 2017. pp. 237-242.
- [48] Gnip, I., S. Vėjelis, and S. Vaitkus. Thermal conductivity of expanded polystyrene (EPS) at 10 C and its conversion to temperatures within interval from 0 to 50 C. *Energy and Buildings*, 52, 2012. pp. 107-111.
- [49] Khoukhi, M. and M. Tahat *Effect of operating temperatures on thermal conductivity of polystyrene insulation material: impact on envelope-induced cooling load*. in *Applied Mechanics and Materials*. 2014. Trans Tech Publ.
- [50] Khoukhi, M. and M. Tahat. Effect of temperature and density variations on thermal conductivity of polystyrene insulation materials in Oman climate. *Journal of Engineering Physics and Thermophysics*, 88(4), 2015. pp. 994-998.
- [51] Zach, J., et al.: Performance evaluation and research of alternative thermal insulations based on sheep wool. *Energy and Buildings*, 49, 2012. pp. 246-253.
- [52] Khoukhi, M., et al.: A dynamic thermal response on thermal conductivity at different temperature and moisture levels of EPS insulation. *Case Studies in Thermal Engineering*, 14, 2019. pp. 100481.
- [53] Manohar, K., et al.: Biodegradable fibrous thermal insulation. *Journal of the Brazilian Society of Mechanical Sciences and Engineering*, 28(1), 2006. pp. 45-47.
- [54] Troppová, E., et al.: Influence of temperature and moisture content on the thermal conductivity of wood-based fibreboards. *Materials and Structures*, 48(12), 2015. pp. 4077-4083.
- [55] Rahim, M., et al.: Effect of moisture and temperature on thermal properties of three bio-based materials. *Construction and Building Materials*, 111, 2016. pp. 119-127.
- [56] Srivaro, S., Z. Börcsök, and Z. Pásztor. Temperature dependence of thermal conductivity of heat-treated rubberwood. *Wood Material Science & Engineering*, 2019. pp. 1-4.
- [57] Ahmed, A., A. Qayoum, and F.Q. Mir. Investigation of the thermal behavior of the natural insulation materials for low temperature regions. *Journal of Building Engineering*, 26, 2019. pp. 100849.
- [58] Baetens, R., et al.: Vacuum insulation panels for building applications: A review and beyond. *Energy and Buildings*, 42(2), 2010. pp. 147-172.

- [59] Lorenzati, A., et al.: The effect of temperature on thermal performance of fumed silica based vacuum insulation panels for buildings. *Energy Procedia*, 111(2016), 2017. pp. 490-499.
- [60] Fantucci, S., et al.: Analysis of the temperature dependence of the thermal conductivity in Vacuum Insulation Panels. *Energy and Buildings*, 183, 2019. pp. 64-74.
- [61] Baetens, R., B.P. Jelle, and A. Gustavsen. Aerogel insulation for building applications: a state-of-the-art review. *Energy and Buildings*, 43(4), 2011. pp. 761-769.
- [62] Zhao, J.-J., et al.: Radiative properties and heat transfer characteristics of fiber-loaded silica aerogel composites for thermal insulation. *International Journal of Heat and Mass Transfer*, 55(19-20), 2012. pp. 5196-5204.
- [63] Xie, T., Y.-L. He, and Z.-J. Hu. Theoretical study on thermal conductivities of silica aerogel composite insulating material. *International journal of heat and mass transfer*, 58(1-2), 2013. pp. 540-552.
- [64] Wei, G., et al.: Thermal conductivities study on silica aerogel and its composite insulation materials. *International Journal of Heat and Mass Transfer*, 54(11-12), 2011. pp. 2355-2366.
- [65] Liu, H., et al.: Experimental investigations on temperature-dependent effective thermal conductivity of nanoporous silica aerogel composite. *Experimental Thermal and Fluid Science*, 84, 2017. pp. 67-77.
- [66] Nosrati, R.H. and U. Berardi. Hygrothermal characteristics of aerogel-enhanced insulating materials under different humidity and temperature conditions. *Energy and Buildings*, 158, 2018. pp. 698-711.
- [67] Guo, H., et al.: Simultaneous test and visual identification of heat and moisture transport in several types of thermal insulation. *Energy*, 197, 2020. pp. 117-137.
- [68] Winkler-Skalna, A. and B. Łoboda. Determination of the thermal insulation properties of cylindrical PUR foam products throughout the entire life cycle using accelerated aging procedures. *Journal of Building Engineering*, 2020. pp. 101348.
- [69] Pinterić, M.: *Building Physics: From physical principles to international standards*. Springer International Publishing, 2017. pp. 262.
- [70] Qin, M., et al.: An analytical method to calculate the coupled heat and moisture transfer in building materials. *International Communications in Heat and Mass Transfer*, 33(1), 2006. pp. 39-48.
- [71] Gusyachkin, A., et al. *Effects of moisture content on thermal conductivity of thermal insulation materials*. in *IOP Conference Series: Materials Science and Engineering*. 2019. IOP Publishing.
- [72] Jerman, M. and R. Černý. Effect of moisture content on heat and moisture transport and storage properties of thermal insulation materials. *Energy and Buildings*, 53, 2012. pp. 39-46.
- [73] Lakatos, Á.: Moisture induced changes in the building physics parameters of insulation materials. *Science and Technology for the Built Environment*, 22(3), 2016. pp. 252-260.
- [74] Lakatos, Á. and F. Kalmár. Analysis of water sorption and thermal conductivity of expanded polystyrene insulation materials. *Building Services Engineering Research and Technology*, 34(4), 2013. pp. 407-416.
- [75] Wang, J., et al.: Mechanism and preliminary performance analysis of exhaust air insulation for building envelope wall. *Energy and Buildings*, 173, 2018. pp. 516-529.
- [76] Ochs, F., W. Heidemann, and H. Müller-Steinhagen. Effective thermal conductivity of moistened insulation materials as a function of temperature. *International Journal of Heat and Mass Transfer*, 51(3-4), 2008. pp. 539-552.
- [77] Liu, Y., et al.: Nonlinear effect of moisture content on effective thermal conductivity of building materials with different pore size distributions. *International Journal of Thermophysics*, 37(6), 2016. pp. 56.

- [78] D'Alessandro, F., et al.: Experimental assessment of the water content influence on thermo-acoustic performance of building insulation materials. *Construction and Building Materials*, 158, 2018. pp. 264-274.
- [79] Zhu, W., S. Cai, and L. Cremaschi. Thermal performance and moisture accumulation of fibrous mechanical pipe insulation systems operating at below-ambient temperature in wet conditions with moisture ingress. *Science and Technology for the Built Environment*, 21(6), 2015. pp. 862-875.
- [80] Liu, M., et al.: Study on thermal insulation and heat transfer properties of wood frame walls. *Wood research*, 63(2), 2018. pp. 249-260.
- [81] Gawin, D.J., J. Kosny, and K. Wilkes. Thermal conductivity of moist cellular concrete-experimental and numerical study. *American Society of Heating, Refrigerating and Air-Conditioning Engineers-ASHRAE*, 2004. pp.
- [82] Taoukil, D., et al.: Moisture content influence on the thermal conductivity and diffusivity of wood-concrete composite. *Construction and Building Materials*, 48, 2013. pp. 104-115.
- [83] Korjenic, A., et al.: Development and performance evaluation of natural thermal-insulation materials composed of renewable resources. *Energy and Buildings*, 43(9), 2011. pp. 2518-2523.
- [84] Boukhattem, L., et al.: Moisture content influence on the thermal conductivity of insulating building materials made from date palm fibers mesh. *Construction and Building Materials*, 148, 2017. pp. 811-823.
- [85] Sonderegger, W. and P. Niemz. Thermal and moisture flux in soft fibreboards. *European Journal of Wood and Wood Products*, 70(1-3), 2012. pp. 25-35.
- [86] Budaiwi, I. and A. Abdou. The impact of thermal conductivity change of moist fibrous insulation on energy performance of buildings under hot-humid conditions. *Energy and Buildings*, 60, 2013. pp. 388-399.
- [87] McFadden, T.: Thermal performance degradation of wet insulations in cold regions. *Journal of cold regions engineering*, 2(1), 1988. pp. 25-34.
- [88] Mahapatra, A.K.: Thermal properties of sweet sorghum bagasse as a function of moisture content. *Agricultural Engineering International: CIGR Journal*, 19(4), 2018. pp. 108-113.
- [89] Lakatos, Á.: Investigation of the moisture induced degradation of the thermal properties of aerogel blankets: Measurements, calculations, simulations. *Energy and Buildings*, 139, 2017. pp. 506-516.
- [90] Hroudova, J. and J. Zach. Acoustic and thermal insulating materials based on natural fibres used in floor construction. *World Acad. Sci. Eng. Technol. Int. J. Civ. Environ. Eng.*, 8, 2014. pp. 1152-1155.
- [91] Cetiner, I. and A.D. Shea. Wood waste as an alternative thermal insulation for buildings. *Energy and Buildings*, 168, 2018. pp. 374-384.
- [92] La Rosa, A., et al.: Environmental impacts and thermal insulation performance of innovative composite solutions for building applications. *Construction and Building Materials*, 55, 2014. pp. 406-414.
- [93] Bribian IZ, C.A., Aranda Urison A.: Life Cycle Assessment of Building Materials: Comparative Analysis of Energy and Environmental Impacts and Evaluation of the Eco-Efficiency Improvement Potential. *Building and Environment*, 46, 2011. pp. 1133-1140.
- [94] Ye, Z., et al.: Thermal conductivity of wool and wool-hemp insulation. *International journal of energy research*, 30(1), 2006. pp. 37-49.
- [95] Limam, A., et al.: Experimental thermal characterization of bio-based materials (Aleppo Pine wood, cork and their composites) for building insulation. *Energy and Buildings*, 116, 2016. pp. 89-95.

- [96] Manohar, K.: Experimental investigation of building thermal insulation from agricultural by-products. *British Journal of Applied Science & Technology*, 2(3), 2012. pp. 227.
- [97] Volf, M., J. Diviš, and F. Havlík. Thermal, moisture and biological behaviour of natural insulating materials. *Energy Procedia*, 78, 2015. pp. 1599-1604.
- [98] Kobayashi, Y., T. Saito, and A. Isogai. Aerogels with 3D ordered nanofiber skeletons of liquid-crystalline nanocellulose derivatives as tough and transparent insulators. *Angewandte Chemie International Edition*, 53(39), 2014. pp. 10394-10397.
- [99] Lakatos, Á. and F. Kalmár. Investigation of thickness and density dependence of thermal conductivity of expanded polystyrene insulation materials. *Materials and structures*, 46(7), 2013. pp. 1101-1105.
- [100] Khoukhi, M., et al.: The impact of changes in thermal conductivity of polystyrene insulation material under different operating temperatures on the heat transfer through the building envelope. *Applied Thermal Engineering*, 105, 2016. pp. 669-674.
- [101] Song, H.Y., X.X. Cheng, and L. Chu *Effect of Density and Ambient Temperature on Coefficient of Thermal Conductivity of Heat-Insulated EPS and PU Materials for Food Packaging*. in *Applied Mechanics and Materials*. 2014. Trans Tech Publ.
- [102] Zach, J., R. Slávik, and V. Novák. Investigation of the process of heat transfer in the structure of thermal insulation materials based on natural fibres. *Procedia Engineering*, 151, 2016. pp. 352-359.
- [103] Collet, F. and S. Prétot. Thermal conductivity of hemp concretes: Variation with formulation, density and water content. *Construction and building materials*, 65, 2014. pp. 612-619.
- [104] Sekino, N.: Density dependence in the thermal conductivity of cellulose fiber mats and wood shavings mats: investigation of the apparent thermal conductivity of coarse pores. *Journal of wood science*, 62(1), 2016. pp. 20-26.
- [105] Balčiūnas, G., et al.: Ecological, thermal and acoustical insulating composite from hemp shives and spropel binder. *Industrial Crops and Products*, 91, 2016. pp. 286-294.
- [106] Bui, H., et al.: Determination and Review of Physical and Mechanical Properties of Raw and Treated Coconut Fibers for Their Recycling in Construction Materials. *Fibers*, 8(6), 2020. pp. 37.
- [107] Koh, C.H.A. and D. Kraniotis. A review of material properties and performance of straw bale as building material. *Construction and Building Materials*, 259, 2020. pp. 120385.
- [108] Tychanicz-Kwiecień, M., J. Wilk, and P. Gil. Review of high-temperature thermal insulation materials. *Journal of Thermophysics and Heat Transfer*, 33(1), 2019. pp. 271-284.
- [109] Wang, B., et al.: Thermal Insulation Properties of Green Vacuum Insulation Panel Using Wood Fiber as Core Material. *BioResources*, 14(2), 2019. pp. 3339-3351.
- [110] Sahu, D.K., et al.: A Review on Thermal Insulation and Its Optimum Thickness to Reduce Heat Loss. *International Journal for Innovative Research in Science & Technology*, 2(06), 2015. pp. 2349-6010.
- [111] Asdrubali, F., F. D'Alessandro, and S. Schiavoni. A review of unconventional sustainable building insulation materials. *Sustainable Materials and Technologies*, 4, 2015. pp. 1-17.
- [112] Mahlia, T., B. Taufiq, and H. Masjuki. Correlation between thermal conductivity and the thickness of selected insulation materials for building wall. *Energy and Buildings*, 39(2), 2007. pp. 182-187.
- [113] Yuan, J.: Impact of insulation type and thickness on the dynamic thermal characteristics of an external wall structure. *Sustainability*, 10(8), 2018. pp. 2835.
- [114] Zhang, T. and H. Yang. Optimal thickness determination of insulating air layers in building envelopes. *Energy Procedia*, 152, 2018. pp. 444-449.

- [115] Sisman, N., et al.: Determination of optimum insulation thicknesses of the external walls and roof (ceiling) for Turkey's different degree-day regions. *Energy Policy*, 35(10), 2007. pp. 5151-5155.
- [116] Kumar, D., et al.: Comparative analysis of building insulation material properties and performance. *Renewable and Sustainable Energy Reviews*, 131, 2020. pp. 110038.
- [117] Ahmad, E.H. *Cost analysis and thickness optimization of thermal insulation materials used in residential buildings in Saudi Arabia*. in *Proceedings of the 6th Saudi Engineering Conference, Dhahran, Saudi Arabia*. 2002.
- [118] Anglès, M., et al.: Binderless composites from pretreated residual softwood. *Journal of Applied Polymer Science*, 73(12), 1999. pp. 2485-2491.
- [119] Kongkaew, P. *Mechanical properties of banana and coconut fibers reinforced epoxy polymer matrix composites*. 2016.
- [120] Naidu, A.L., V. Jagadeesh, and M.R. Bahubalendruni. A review on chemical and physical properties of natural fiber reinforced composites. *Journal of Advanced Research in Engineering and Technology*, 8(1), 2017. pp. 56-68.
- [121] Hasan, K.F., et al.: A state-of-the-art review on coir fiber-reinforced biocomposites. *RSC Advances*, 11(18), 2021. pp. 10548-10571.
- [122] Suardana, N., I. Lokantara, and J.K. Lim. Influence of water absorption on mechanical properties of coconut coir fiber/poly-lactic acid biocomposites. *Materials Physics and Mechanics*, 12(2), 2011. pp. 113-125.
- [123] Balaji, A., B. Karthikeyan, and C.S. Raj. Bagasse fiber—the future biocomposite material: a review. *International Journal of Cemtech Research*, 7(1), 2014. pp. 223-233.
- [124] Nunes, L.J., et al.: Sugarcane industry waste recovery: a case study using thermochemical conversion technologies to increase sustainability. *Applied Sciences*, 10(18), 2020. pp. 6481.
- [125] Hattalli, S., et al.: Adding value to Alfa grass (*Stipa tenacissima* L.) soda lignin as phenolic resins 1. Lignin characterization. *Polymer Degradation and Stability*, 76(2), 2002. pp. 259-264.
- [126] Devadiga, D.G., K.S. Bhat, and G. Mahesha. Sugarcane bagasse fiber reinforced composites: Recent advances and applications. *Cogent Engineering*, 7(1), 2020. pp. 1823159.
- [127] Prabakaran, *Investigation in Moisture Characteristics of Sugarcane Bagasse Fiber*. 2017, Angel college of Engineering and Technology: India.
- [128] Nonaka, S., K. Umemura, and S. Kawai. Characterization of bagasse binderless particleboard manufactured in high-temperature range. *Journal of wood science*, 59(1), 2013. pp. 50-56.
- [129] Hasan, K.F., et al.: Rice straw and energy reeds ber reinforced phenol formaldehyde resin hybrid polymeric composite panels. 2021. pp.
- [130] Hasan, K., et al.: Novel insulation panels development from multilayered coir short and long fiber reinforced phenol formaldehyde polymeric biocomposites. *Journal of Polymer Research*, 28(12), 2021. pp. 1-16.
- [131] Srivaro, S., et al.: Physical, mechanical and thermal properties of cross laminated timber made with coconut wood. *European Journal of Wood and Wood Products*, 2021. pp.
- [132] Committee, E.S.: EN 12667; Thermal Performance of Building Materials and Products—Determination of Thermal Resistance by Means of Guarded Hot Plate and Heat Flow Meter Methods—Products of High and Medium Thermal Resistance. *British Standards: London, UK*, 2001. pp.
- [133] Smith, B.C. *Fundamentals of Fourier transform infrared spectroscopy*. CRC press, 2011.
- [134] EN, B.: 15026: 2007: Hygrothermal performance of building components and building elements-Assessment of moisture transfer by numerical simulation. German version DIN EN, 15026, 2007. pp.

- [135] Anh, L.D.H. and P. Zoltán. An Overview of Factors Influencing Thermal Conductivity of Building Insulation Materials. *Journal of Building Engineering*, 44, 2021. pp. 102604.
- [136] Mahmud, S., et al.: Comprehensive review on plant-fiber reinforced polymeric biocomposites. *Journal of Materials Science*, 2021. pp.
- [137] Le, D.H.A. and Z. Pásztor. An Overview of Factors Influencing Thermal Conductivity of Building Insulation Materials. *Journal of Building Engineering*, 44, 2021. pp. 102604.
- [138] Saravana, B. and K. Mohan, *Thermal properties of maize fiber reinforced unsaturated polyester resin composites*. 2013.
- [139] Yang, Y., *Thermal conductivity*, in *Physical properties of polymers handbook*. 2007, Springer. p. 155-163.
- [140] Harper, C.A. *Handbook of plastics, elastomers, and composites*. McGraw-Hill Education, 2002.
- [141] Akyildiz, M.H. and H. Kol Sahin. Some technological properties and uses of paulownia (*Paulownia tomentosa* Steud.) wood. 2010. pp.
- [142] Asadi, I., et al.: Thermal conductivity of concrete—A review. *Journal of Building Engineering*, 20, 2018. pp. 81-93.
- [143] Furtini, A.C.C., et al.: Performance of cross laminated timber panels made of *Pinus oocarpa* and *Coffea arabica* waste. 2021. pp.
- [144] Zhou, X.-y., et al.: An environment-friendly thermal insulation material from cotton stalk fibers. *Energy and Buildings*, 42(7), 2010. pp. 1070-1074.
- [145] Mehrzad, S., et al.: Sugarcane bagasse waste fibers as novel thermal insulation and sound-absorbing materials for application in sustainable buildings. *Building and Environment*, 211, 2022. pp. 108753.
- [146] Monahar, G.K.a.K.: Effect of Moisture on Thermal Conductivity of Fibers Biological Insulation Materials. *Thermal Performance of Exterior Envelopes of Buildings VI*, 1995. pp.
- [147] Abedom, F., et al.: Development of natural fiber hybrid composites using sugarcane bagasse and bamboo charcoal for automotive thermal insulation materials. *Advances in Materials Science and Engineering*, 2021, 2021. pp.
- [148] Nguyen, D.M., et al.: Building bio-insulation materials based on bamboo powder and bio-binders. *Construction and Building Materials*, 186, 2018. pp. 686-698.
- [149] Etuk, S.E., L.E. Akpabio, and K.E. Akpabio. Determination of thermal properties of *Cocos Nucifera* trunk for predicting temperature variation with its thickness. *Arabian Journal for Science and Engineering*, 30(1A), 2005. pp. 122.
- [150] Samarasekara, S.A.L. and R.V. Coorey *Thermal capacity as a function of moisture content of Sri Lankan wood species: Wheatstone bridge method*. in *Proceedings of the Technical Sessions*. 2011.
- [151] Glass, S.V.Z., Samuel L. Moisture relations and physical properties of wood. General technical report FPL ; GTR-190. Madison, WI : U.S. Dept. of Agriculture, Forest Service, Forest Products Laboratory, 2010, 2010.
- [152] Shah, D.U., et al.: Thermal conductivity of engineered bamboo composites. *Journal of Materials Science*, 51(6), 2016. pp. 2991-3002.
- [153] Gößwald, J., et al.: Binderless Thermal Insulation Panels Made of Spruce Bark Fibres. *Polymers*, 13(11), 2021. pp. 1799.
- [154] Florea, I. and D.L. Manea. Analysis of Thermal Insulation Building Materials Based on Natural Fibers. *Procedia Manufacturing*, 32, 2019. pp. 230-235.
- [155] Hill, C. and M. Hughes. Natural fibre reinforced composites opportunities and challenges. *Journal of Biobased Materials and Bioenergy*, 4(2), 2010. pp. 148-158.
- [156] Marques, B., et al.: Characterisation of sustainable building walls made from rice straw bales. *Journal of Building Engineering*, 28, 2020. pp. 101041.

- [157] Barsberg, S. and L.G. Thygesen. Nonequilibrium phenomena influencing the wetting behavior of plant fibers. *Journal of colloid and interface science*, 234(1), 2001. pp. 59-67.
- [158] Mahapatra, A.K.: Thermal properties of sweet sorghum bagasse as a function of moisture content. *Agricultural Engineering International: CIGR Journal*, 19(4), 2017. pp. 108-113.
- [159] Artschwager, E.: *Anatomy of the Vegetative Organs of Sugar Cane*. 1925. pp. p. 197-241. plates.-USDA.
- [160] Botha, C.E., R.H. Cross, and J. Gerber. The microstructure of plasmodesmata in internodal stem tissue of the *Saccharum* hybrid var. NCo376: evidence for an apoplasmic loading pathway. *South African Journal of Science*, 100(11), 2004. pp. 619-623.
- [161] Balaji, A., et al.: Effect of filler content of chemically treated short bagasse fiber-reinforced cardanol polymer composites. *Journal of Natural Fibers*, 2018. pp.
- [162] Vidyashri, V., et al.: Preparation of chemically treated sugarcane bagasse fiber reinforced epoxy composites and their characterization. *Cogent Engineering*, 6(1), 2019. pp. 1708644.
- [163] Guimarães, J., et al.: Characterization of banana, sugarcane bagasse and sponge gourd fibers of Brazil. *Industrial Crops and Products*, 30(3), 2009. pp. 407-415.
- [164] Jaiswal, D. and G. Devnani, *Bagasse fibers, their composites and applications*, in *Plant Fibers, their Composites, and Applications*. 2022, Elsevier. p. 111-130.
- [165] Zhao, X., et al.: Delignification of sugarcane bagasse with alkali and peracetic acid and characterization of the pulp. *BioResources*, 5(3), 2010. pp.
- [166] Jayamani, E., et al.: Comparative study of fly ash/sugarcane fiber reinforced polymer composites properties. *BioResources*, 15(3), 2020. pp. 5514.
- [167] Balaji, A., et al.: Thermal behavior of cardanol resin reinforced 20 mm long untreated bagasse fiber composites. *International Journal of Polymer Analysis and Characterization*, 23(1), 2018. pp. 70-77.
- [168] Nguyen, L., et al.: Experimental study on the thermal properties of lightweight aggregate concretes at different moisture contents and ambient temperatures. *Construction and Building Materials*, 151, 2017. pp. 720-731.
- [169] Steeman, H.-J., et al.: Coupled simulation of heat and moisture transport in air and porous materials for the assessment of moisture related damage. *Building and Environment*, 44(10), 2009. pp. 2176-2184.
- [170] Talukdar, P., et al.: An experimental data set for benchmarking 1-D, transient heat and moisture transfer models of hygroscopic building materials. Part I: Experimental facility and material property data. *International journal of heat and mass transfer*, 50(23-24), 2007. pp. 4527-4539.
- [171] Mohan, V.C. and P. Talukdar. Three dimensional numerical modeling of simultaneous heat and moisture transfer in a moist object subjected to convective drying. *International Journal of Heat and Mass Transfer*, 53(21-22), 2010. pp. 4638-4650.
- [172] Künzle, H.M.: Simultaneous heat and moisture transport in building components. One- and two-dimensional calculation using simple parameters. IRB-Verlag Stuttgart, 65, 1995. pp.
- [173] Wijesundera, N., et al.: Numerical simulation of the transient moisture transfer through porous insulation. *International journal of heat and mass transfer*, 39(5), 1996. pp. 995-1004.
- [174] *Basic Properties of Building Decorative Materials*, in *Building Decorative Materials*, Y. Li and S. Ren, Editors. 2011, Woodhead Publishing. p. 10-24.

- [175] Wang, Y., et al.: Effect of moisture migration and phase change on effective thermal conductivity of porous building materials. *International Journal of Heat and Mass Transfer*, 125, 2018. pp. 330-342.
- [176] Wang, Y., et al.: The impact of temperature and relative humidity dependent thermal conductivity of insulation materials on heat transfer through the building envelope. *Journal of Building Engineering*, 46, 2022. pp. 103700.