

PhD Dissertation

University of Sopron (Soproni Egyetem)

Simonyi Károly Faculty of Engineering, Wood Sciences and Applied Art

József Cziráki Doctoral School of Wood Sciences and Technologies

Improving the Fire Resistance of Cement Bonded Particle Board made of poplar and Scots pine particles pre-treated with Boron and Phosphorus Compounds



Author: Fatima Zohra Brahmia

Researcher Supervisors: Dr. Tibor Alpár

Dr. Péter György Horváth

Sopron

2021

Improving the Fire Resistance of Cement Bonded Particle Board made of poplar and Scots pine particles pre-treated with Boron and Phosphorus Compounds

Dissertation for doctoral (PhD) degree  
University of Sopron József Cziráki Doctoral School  
of Wood Sciences and Technologies  
..... programme

Written by:  
Fatima Zohra Brahmia

Made in the framework of  
..... programme

of the József Cziráki Doctoral School, University of Sopron  
Supervisor: Dr. Alpár Tibor, Dr Péter György Horváth

I recommend for acceptance (yes / no)

(signature)

The candidate reached ..... % at the comprehensive exam,  
Sopron, .....

Chairman of the Examination Board

As assessor I recommend the dissertation for acceptance (yes/no)

First assessor (Dr. ....) yes/no

(signature)

Second assessor (Dr. ....) yes/no

(signature)

(Possible third assessor (Dr. ....) yes/no

(signature)

The candidate reached .....% in the public debate of the dissertation  
Sopron,

.....  
Chairman of the Assessor Committee

Qualification of the doctoral (PhD) degree .....

.....  
Chairman of the University Doctoral  
and Habilitation Council (UDHC)

## DECLARATION

I, the undersigned Fatima Zohra Brahmia by signing this declaration declare that my PhD thesis entitled Improving the Fire Resistance of Cement Bonded Particle Board made of poplar and Scots pine particles pre-treated with Boron and Phosphorus Compounds was my own work; during the dissertation I complied with the regulations of Act LXXVI of 1999 on Copyright and the rules of the doctoral dissertation prescribed by the József Cziráki Doctoral School of Wood Sciences and Technologies, especially regarding references and citations.<sup>1</sup> Furthermore, I declare that during the preparation of the dissertation I did not mislead my supervisor(s) or the programme leader with regard to the independent research work. By signing this declaration, I acknowledge that if it can be proved that the dissertation is not self-made or the author of a copyright infringement is related to the dissertation, the University of Sopron is entitled to refuse the acceptance of the dissertation. Refusing to accept a dissertation does not affect any other legal (civil law, misdemeanour law, criminal law) consequences of copyright infringement.

Sopron, ..... 20....

.....

Fatima Zohra Brahmia

---

## Acknowledgments

This work would not have been possible without the help of god and support of some people to whom I am indebted.

My dissertation became possible because of my supervisors Dr. Alpár Tibor and Dr. Péter György Horváth, through their help over the last 4 years by countless discussions and valuable advises for the success of this work. In first place, I would like to thank Dr. Tibor Alpár for his eagerness that I acquire the needed knowledge in the field of wood science and cement wood composite industry. In addition, helping me with answering my entire questions at any time and finding solution to problem that occurred during my work and believing in me. In second, Dr. Péter György Horvath for sharing with me his knowledge about fire safety and for the longest hours that he spends daily with me in the lab helping me running my experiment and keeping me safe.

The extensive experiment in my dissertation were not being possible without the kindness of many professors by sharing their knowledge and equipment's with me. In this case, I would like to thank Dr. Janos Madarasz, Dr. Fehér Sándor, Dr. Endre Magoss, Dr. Csilla Csiha, Dr. Miklós Bak, Dr. Zoltán Pásztor, Dr. Zoltán Börcsök and Dr. Katalin Halász. I would like to thank István Isó for helping in cutting all boards.

I would like to give special thanks to Prof. Dr. Kovács Zsolt for the help, support and time he gives me since I start studying in the University of Sopron. I learn a lot from him. He is treasure of knowledge.

I would like to extend my gratitude to the Tempus foundation for giving me the chance of doing my PhD under the Stipendium hungaricum Scholarship and to the „EFOP-3.6.1-16-2016-00018 – Improving the role of research+ development+ innovation in the higher education through institutional developments assisting intelligent specialization in Sopron and Szombathely” for supporting financially the research work.

Finally, I would like to thank my mother, grandmother, aunt Fatiha Zerdoudi, uncle Mourad Zerdoudi, my beloved siblings Tarek and Joumana, my husband Rami Benkreif and all my friends for their support and love and especial thank to my mother who teach me how to be independent woman with ambition and love for knowledge. In addition, for having confidante in me and letting me study abroad.

## Table of Contents

Abstract.....	1
Absztrakt.....	2
1. Introduction.....	3
1.1 Background.....	3
1.2 Cement wood composites (CWC).....	3
1.3 Problem statement and settings of the investigations.....	4
1.4 Dissertation structure.....	8
2 Literature review .....	10
2.1 Background .....	10
2.1.1 Cement fibre wood and cement bonded particleboard (CBPB).....	13
2.1.2 Wood-wool cement boards (WWCB) .....	13
2.1.3 Building blocks .....	13
2.2 Mechanics of Wood and Cement Bonding.....	14
2.2.1 Cement hydration .....	14
2.2.2 Influence of Wood Species on Cement Curing.....	16
2.3 Effect of Pre-treatments on Compatibility of Cement and Wood.....	18
2.4 Effect of Additives and Wood/Cement Ratio on Properties of CWC.....	20
2.5 Treatment for Accelerating Cement Curing .....	23
2.5.1 Carbon Dioxide (CO <sub>2</sub> ).....	23
2.6 Fire Resistance of Cement Wood Composite .....	24
2.7 New prospective for CWC enhancement .....	25
2.7.1 Wood combustion .....	26
2.7.1.1 Pyrolysis.....	26
2.7.1.2 Char.....	26

2.7.1.3	Smoke .....	27
2.7.1.4	Solution to overcome the wood combustion problem .....	27
2.7.2	Pre-treatment Fire retardants for wood.....	29
2.7.2.1	Phosphorus compounds.....	29
2.7.2.2	Boron compounds.....	29
2.7.2.3	Polyethylene glycol.....	30
2.7.3	Fire retardants treatment technology .....	31
2.8	Selected CBPB Components and influencing factors on fire retardant performance ....	31
3	Materials and Methods .....	36
3.1	Part I: Primarily test .....	36
3.1.1	Description of the used material .....	36
3.1.2	Description of used experimental methods.....	37
3.1.2.1	Surface Roughness test .....	37
3.1.2.2	Wettability test.....	37
3.1.2.3	Lindner test.....	39
3.1.2.4	The singe flame source test.....	40
3.1.2.5	The bomb calorimeter test.....	41
3.1.2.6	Hydration test .....	41
3.2	Part II: CBPB tests .....	42
3.2.1	Raw materials and chemicals.....	42
3.2.2	Experimental settings: .....	43
3.2.2.1	Fire retardant preparation.....	43
3.2.2.2	Wood particle preparation.....	43
3.2.2.3	Wood particle extractives and size distribution.....	43
3.2.2.4	CBPB production, mat formation and processing .....	44
3.2.2.5	Mechanical properties .....	47
3.2.2.5.1	Bending test .....	47

3.2.2.5.2	Internal bond test (IBS) .....	48
3.2.2.5.3	Thickness swelling test (TS).....	49
3.2.2.6	Fire performance.....	49
3.2.2.6.1	The single flame source test.....	49
3.2.2.6.2	The non-combustibility test .....	50
3.2.2.7	Characterization methods used for testing specimens .....	51
3.2.2.7.1	Scanning electron microscopy (SEM).....	51
3.2.2.7.2	Thermal gravimetric Analysis (TGA) .....	51
3.2.2.7.3	X-ray diffraction (XRD).....	51
3.2.2.7.4	Dynamic mechanical analysis (DMA) .....	52
4	Results and Discussion.....	53
4.1	Part I: Primarily test results and discussion .....	53
4.1.1	Results .....	53
4.1.1.1	Surface roughness.....	53
4.1.1.2	Contact angle measurement .....	54
4.1.1.3	Experimental analysis for Fire tests:.....	55
4.1.1.4	Hydration test .....	63
4.1.2	Discussion.....	64
4	Part 2: CBPB test results and discussion .....	68
4.2.1	Properties of wood particles .....	68
4.2.1.1	Wood particles size .....	68
4.2.1.2	Sugar and tannin content.....	69
4.2.2	Hygroscopic and Mechanical properties of CBPB's:.....	70
4.2.2.1	Fulfilment of standard requirements of the Produced CBPB:.....	70
4.2.2.1.1	MOR and Density .....	70
4.2.2.1.2	IBS and TS.....	72
4.2.2.1.3	Scanning electron microscopy (SEM) evaluation.....	74

4.2.2.2	Experimental analysis for hygroscopic and mechanical properties:.....	76
4.2.2.3	Detailed statistical inferences:.....	77
4.2.3	Flammability properties:.....	81
4.2.3.1	Standard requirements fulfilment for fire classification: .....	81
4.2.3.1.1	Non combustibility test:.....	81
4.2.3.1.2	Single flame source test:.....	83
4.2.3.2	Non combustibility test statistical analysis .....	85
4.2.4	Comparison of the thermal and mechanical characteristics of the produced CBPB's and the effect of fire retardants pre-treatment on the cement wood mixture curing.....	87
4.2.4.1	X-Ray Diffraction (XRD) and Scanning Electron Microscopy (SEM).....	87
4.2.4.2	Thermal gravimetric analysis (TGA).....	90
4.2.4.3	Dynamic mechanical analysis (DMA).....	94
	Summary.....	98
	List of literature.....	101
	Appendix	

## List of Figures

<b>Figure 2. 1:</b> Schematic diagram of different types of Cement Wood Composites (CWC). .....	12
<b>Figure 2. 2:</b> Schematic diagram of typical temperature plot of cement-wood mixture [40]. .....	15
<b>Figure 2. 3:</b> Schematic diagram represents wood combustion process [85].....	28
<b>Figure 2. 4:</b> Contact angle ( $\theta$ ). .....	34
<b>Figure 3. 1:</b> Wettability test experimental setting. ....	38
<b>Figure 3. 2:</b> Schematic description of contact angle measurement by PGx goniometer. ....	38
<b>Figure 3. 3:</b> Fire tests experimental setting.....	39
<b>Figure 3. 4:</b> The single flame source test.....	40
<b>Figure 3. 5:</b> Calorimeter test experimental setting. ....	41
<b>Figure 3. 6:</b> Schematic description for hydration test.....	42
<b>Figure 3. 7:</b> Schematic diagram explains the bending test. ....	48
<b>Figure 3. 8:</b> Schematic diagram explains the internal bond test. ....	49
<b>Figure 3. 9:</b> Wazau non- combustibility apparatus and specimen .....	50
<b>Figure 3. 10:</b> Hitachi S-3400N scanning electron microscopy and specimens.....	51
<b>Figure 3. 11:</b> Schematic diagram Explain how XRD works with X'Pert Pro XRD. ....	52
<b>Figure 3. 12:</b> METRAVIB DMA 50 machine and test specimen . ....	52
<b>Figure 4. 1:</b> Rz surface roughness of Poplar (P) and Scots pine (S) with sawn, sanded and planed surfaces. ....	53
<b>Figure 4. 2:</b> Contact angle values of Poplar and Scots pine for all surfaces with all test liquids. ....	54
<b>Figure 4. 3:</b> Dot plot of measurements for Linder test for sanded scots pine.....	56
<b>Figure 4. 4:</b> Descriptive statistics analysis for Mass loss for Linder test sanded scots pine species treated with DAHP 300 g/L with extreme outlier (a). Descriptive statistics analysis after deleting extreme outlier (b). ....	56
<b>Figure 4. 5:</b> Mass loss (g), Scots pine results (a), results of poplar (b). ....	59
<b>Figure 4. 6:</b> Burning length (cm), Scots pine results (up), results of poplar (down). ....	61
<b>Figure 4. 7:</b> Heat of Combustion (MJ/kg) For Scots pine and poplar. ....	62
<b>Figure 4. 8:</b> Hydration test of cement treated with different fire retardants, Temperature change within 24 hours of cement curing.....	63

<b>Figure 4. 9:</b> Fire retardant amount in treated wood particles after 24 hours of drying. ....	64
<b>Figure 4. 10:</b> (a) Sample of poplar treated with DAHP 300 g/l. (b) Sample of Scots pine treated with DAHP 300 g/l. Both figures show a thin film on the surface of samples that is caused by DAHP 300 g/l.....	66
<b>Figure 4. 11:</b> Scots pine and poplar particle Size distribution that used for surface and core layers. ....	69
<b>Figure 4. 12:</b> Tannin content diagram. ....	70
<b>Figure 4. 13:</b> MOR (MPa) and Density (%) of CBPB (a) CBPB made of Scots pine with SS as additive, (b) CBPB made of Scots pine with PDDA+ MM additive as additive, (c) CBPB made of poplar with as additive SS, (d) CBPB made of poplar with PDDA+ MM additive as additive. ...	72
<b>Figure 4. 14:</b> IBS (MPa) and TS (%) of CBPB (a) CBPB made of Scots pine with SS as additive, (b) CBPB made of Scots pine with PDDA+ MM additive as additive, (c) CBPB made of poplar with as additive SS , (d) CBPB made of poplar with PDDA+ MM additive as additive. ....	74
<b>Figure 4. 15:</b> SEM images for CBPB's. (a) CBPB Sc-N-SS-5. (b) CBPB Sc-N-PM-20. (c) CBPB Sc-B-SS-5. (d) CBPB Sc-DA-SS-5. (e) CBPB Sc-DA-PM-20. (f) CBPB P-N-PM-20. (g) CBPB P-B-PM-20. (h) CBPB P-DA-SS-5. (i) CBPB P-DA-PM-20.....	75
<b>Figure 4. 16:</b> $\Delta T$ ( $^{\circ}$ ), $\Delta m$ (g) and $\Delta t$ (s) of non-combustibility test for CBPB made of Scots pine. ....	82
<b>Figure 4. 17:</b> Flame spread of CBPB made of poplar and Scots pine. Flame spread on surface of specimens.....	83
<b>Figure 4. 18:</b> Flame spread of CBPB made of poplar and Scots pine. Flame spread on edge of specimens (left) Scots pine, (right) poplar.....	83
<b>Figure 4. 19:</b> Flame spread of CBPB made of poplar and Scots pine. Flame spread on the side of specimens for poplar and scots pine CBPB. ....	84
<b>Figure 4. 20:</b> XRD of CBPB's after 28 days of curing made of Scots pine with SS and PDDA+MM as additives.....	88
<b>Figure 4. 21:</b> XRD of CBPB's after 28 days curing made of poplar with SS and PDDA+MM as additives.....	89
<b>Figure 4. 22:</b> SEM images for CBPB'S with (x5k). (a) CBPB Sc-N-SS-5. (b) CBPB Sc-N-PM-20. (c) CBPB Sc-B-SS-5. (d) CBPB Sc-DS-SS-5. (e) CBPB Sc-DS-PM-20. (f) CBPB Sc-DA-SS-5. (g) CBPB Sc-DA-PM-20. (h) CBPB P-N-SS-5. (i) CBPB P-N-PM-20. (j) CBPB P-B-SS-5. (k) CBPB P-B-PM-20. (l) CBPB P-DS-SS-5. (m) CBPB P-DS-PM-20. (o) CBPB P-DA-SS-5. (p) CBPB P-DA-PM-20. ....	90
<b>Figure 4. 23:</b> TGA of CBPB after 28 day of curing (a) CBPB made of Scots pine and SS.....	90

<b>Figure 4. 24:</b> TGA of CBPB after 28 day of curing CBPB made of Scots pine and PDDA+MM. .....	91
<b>Figure 4. 25:</b> TGA of CBPB after 28 day of curing CBPB made of poplar and SS. ....	91
<b>Figure 4. 26:</b> TGA of CBPB after 28 day of curing CBPB made of poplar and PDDA+MM. ...	92
<b>Figure 4. 27:</b> Storage Modulus of CBPB after 28 day of curing for DMA test (a) CBPB made of Scots pine and PDDA+MM. (b) CBPB made of Scots pine and SS. (c) CBPB made of poplar and PDDA+MM. (d) CBPB made of poplar and SS. ....	94
<b>Figure 4. 28:</b> Loss Modulus of CBPB after 28 day of curing for DMA test (a) CBPB made of Scots pine and PDDA+MM. (b) CBPB made of Scots pine and SS. (c) CBPB made of poplar and PDDA+MM. (d) CBPB made of poplar and SS. ....	95
<b>Figure 4. 29:</b> Loss Factor of CBPB after 28 day of curing for DMA test (a) (a) CBPB made of Scots pine and PDDA+MM. (b) CBPB made of Scots pine and SS. (c) CBPB made of poplar and PDDA+MM. (d) CBPB made of poplar and SS. ....	96

## List of Tables

<b>Table 2. 1:</b> Types of cement.....	14
<b>Table 2. 2:</b> Effect of Different Pre-treatments on the Compatibility Factor $C_A$ (%) of Different Wood Species.....	20
<b>Table 3. 1:</b> concentration of the fire retardants in scope.....	36
<b>Table 3. 2:</b> Hydration test experimental setting. ....	42
<b>Table 3. 3:</b> CBPB recipe production.....	44
<b>Table 3. 4:</b> Produced CBPBs and experimental matrix (NB: number of replication).....	45
<b>Table 3. 5:</b> Tests Conducted on CBPBs, number of samples per variant for each test and the used board for each test. ....	46
<b>Table 3. 6:</b> Requirements for specified properties according to MSZ EN 634-2:2007 [142].....	47
<b>Table 3. 7:</b> Classes of reaction to fire performance for construction product EN ISO 13501-1:2007 +A1:2010. ....	50
<b>Table 4. 1:</b> Surface roughness ( $\mu\text{m}$ ).....	53
<b>Table 4. 2:</b> Univariate Tests of Significance, Effect Sizes, and Powers for Scots pine and poplar mass loss. ....	57
<b>Table 4. 3:</b> Univariate Tests of Significance, Effect Sizes, and Powers for Scots pine and poplar Burning length.....	58
<b>Table 4. 4:</b> Univariate Tests of Significance, Effect Sizes, and Powers for scots pine, poplar, and date palm leaflet Combustion heat. ....	58
<b>Table 4. 5:</b> Weight loss (%) at the temperature ranges ( $^{\circ}\text{C}$ ) ((38-260), (260-385), (406-510), (545-800)). ....	93

## List of Abbreviations and Notations

<b>ANOVA</b>	Analysis of variances
<b>A</b>	Alite
<b>ATH</b>	Aluminium trihydrate
<b>B</b>	Borax
<b>Borax</b>	Disodium-tetra borate
<b>C</b>	Calcite
<b>C<sub>A</sub></b>	Compatibility factor
<b>CBPB</b>	Cement Bonded Particle Board
<b>CEM</b>	Cement
<b>CFS</b>	Center of Fire Statistics
<b>CH, P</b>	Portlandite
<b>CO<sub>2</sub></b>	Carbon Dioxide
<b>CS</b>	Compression strength
<b>CSP</b>	Copper(II) sulfate pentahydrate
<b>CTIF</b>	International Association of Fire and Rescue Services
<b>CWC</b>	Cement Wood Composite
<b>DAHP</b>	Diammonium Hydrogen Phosphate
<b>DM</b>	Diiodomethane
<b>DMA</b>	Dynamic Mechanical Analysis
<b>DSHP</b>	Disodium Hydrogen Phosphate
<b>DW</b>	Distilled Water
<b>E</b>	Ettringite

<b>E'</b>	Storage modulus
<b>E''</b>	Loss modulus
<b>Eq</b>	Equation
<b>F</b>	Ferrite
<b>FR</b>	Fire Retardant
<b>IB</b>	Internal Bond
<b>IBS</b>	Internal bond strength
<b>LAT</b>	Lead Acetate Trihydrate
<b>Magnesia</b>	Magnesium oxide
<b>MC</b>	Moister Content
<b>MOE</b>	Modulus of elasticity
<b>MOR</b>	Modulus of rupture
<b>MM</b>	Montmorillonite
<b>NB</b>	Number of replacation
<b><math>\theta</math></b>	Contact angle
<b><math>\theta_w</math></b>	Apparent contact angle of Winzel
<b><math>\theta_Y</math></b>	Young contact angle
<b>P</b>	Poplar
<b>PF</b>	Phenol formaldehyde
<b>PP</b>	Planed Poplar
<b>PDDA</b>	Polydiallyldimethylammonium chloride
<b>PEG 400</b>	Polyethylene glycol 400
<b>PM</b>	Polydiallyldimethylammonium chloride + Montmorillonite
<b>PSTT</b>	Potassium sodium tartrate tetrahydrate

<b>R</b>	Recipie
<b>R<sub>a</sub></b>	The mean roughness
<b>R<sub>z</sub></b>	The mean roughness
<b>R<sub>max</sub></b>	The maximum roughness
<b>RH</b>	Relative Humidity
<b>S</b>	Sanded
<b>SA</b>	Sulfuric acid
<b>Sc</b>	Scots pine
<b>SS</b>	Sodium Silicate
<b>SEM</b>	Scanning Electron Microscopy
<b>TGA</b>	Thermal Gravimetric Analysis
<b>TS</b>	Thickness swelling
<b>WA</b>	Water absorption
<b>WSCB</b>	Wood strand cement board
<b>WWCB</b>	Wood-wool cement boards
<b>XRD</b>	X-ray diffraction
$\gamma_{sv}$	Surface tension at the solid-vapour interface
$\gamma_{sl}$	Surface tension at solid- liquid interface
$\gamma_{lv}$	Surface tension at liquid-vapour interface
<b>ZB</b>	Zinc borate

## Abstract

Fire safety is an important aspect in buildings. Improving the fire resistance of building construction materials is needed especially with the continuous changes in requirements and regulations on both the global and national level. Cement bonded particleboard (CBPB) as containing wood material, its fire resistance needs to be improved. Fire retardant pre-treatments of wood particles can improve its fire resistance, however, in lack of information on influence of FR's on cement curing pre-tests were needed in order to study the FR's effect on wood species and cement curing. Eco friendly, low cost and low toxicity FR's were chosen: Borax ( $Na_2B_4O_7$ ), DSHP ( $Na_2HPO_4$ ), DAHP ( $(NH_2)_4HPO_4$ ), and PEG 400. Pre-tests results of FR's on poplar and Scot's pine indicated that the concentration of FR's has a positive effect on fire resistance of wood and a negative effect on cement curing. For wettability, surface roughness has a strong influence only with a high concentration of FR's in case of poplar. Wettability found inverse proportionate to fire retardancy, lower wettability gives higher fire resistance, contradicts the original presumption "good wetting gives good fire retardancy". After evaluation of results, it was decided to use borax, DSHP 77g/l, and DAHP 300 g/l. however, DAHP 300g/l had a higher influence on cement curing than expected, it was reduced to 150 g/l concentration. CBPB's were produced from an untreated and pre-treated wood particle of poplar and scots pine with the use of Portland cement and two types of additives SS and PDDA+MM as accelerators. Based on test results, FR's reduced mechanical properties of CBPB's. However, with the increase of the used additives amount, the mechanical properties increased and full field the standard requirements. DAHP 150 g/l is the only FR enhanced the fire resistance of both wood species and upgrade the fire classification of the CBPB from class B-s1, d0 to A1 with 5 % of SS as an additive, or with 20 % of PDDA+MM additive and then the CBPB was soaked into SS solution. Characteristics of the cement wood mixture were studied XRD patterns and SEM images showed that no new crystalline phases appeared in the hydrated mixture. The dynamic mechanical analysis showed that temperature has a negative influence on the CBPB's. High storage modulus ( $E'$ ) is associated with high MOR and the inverse as well. CBPB's made of poplar have higher loss modulus ( $E''$ ) than CBPB's made of Scots pine that means CBPB's made of poplar have higher elasticity than of Scots' pine.

## Absztrakt

A tűzbiztonság fontos szempont az építőiparban, az építőanyagok tűzállóságának javítására folyamatos az igény, különösen a követelmények és előírások globális és nemzeti szintű folyamatos változásával. A cementkötésű forgácslapok (CK lap) faanyagot tartalmaznak, ezért javítani kell annak tűzállóságát. A faforgácsok tűzgátlószerekkel (TSz) történő előkezelése javíthatja a tűzállóságot, azonban az TSz-nek a cementkötésre gyakorolt hatására vonatkozó információk hiányában előzetes vizsgálatokra volt szükség ahhoz, hogy tanulmányozzuk a TSz fafajokra és cementkötésre gyakorolt hatását. Környezetbarát, alacsony költségű és alacsony toxicitású TSz-eket választottunk: Bórax ( $\text{Na}_2\text{B}_4\text{O}_7$ ), DSHP ( $\text{Na}_2\text{HPO}_4$ ), DAHP ( $(\text{NH}_2)_4\text{HPO}_4$ ) és PEG 400. A TSz pozitív hatással volt a fa tűzállóságára és negatív hatással a cement kötésére. A nedvesíthetőség szempontjából a felületi érdességnek csak nagy TSz-koncentráció mellett van jelentős hatása. A nedvesíthetőség fordítottan arányos a tűzgátlással, az alacsonyabb nedvesíthetőség nagyobb tűzállóságot eredményez, ami ellentmond az eredeti feltételezésnek: „a jó nedvesítés jó tűzgátlást ad”. Az eredmények kiértékelése után úgy döntöttünk, hogy bóraxot, DSHP 77 g/l és DAHP 300 g/l-t alkalmazunk. A 300 g/l DAHP azonban a vártnál nagyobb negatív hatással volt a cement kikeményedésére, ezért a koncentrációját 150 g/l-re csökkentettük. A CK lapokat kezeletlen és előkezelt nyárfa és erdeifenyő forgácsokból készítettük portlandcement alkalmazásával, és nátron vízüveget ill. PDDA + MM adalékot használtunk kötésgyorsítóként. A vizsgálati eredmények alapján az TSz csökkentette a CK lapok mechanikai tulajdonságait. Az adalékok mennyiségének növekedésével azonban a mechanikai tulajdonságok növekedtek és így megfelelnek a szabvány követelményeinek. A 150 g/l DAHP az egyetlen TSz, amely fokozta mindkét fafaj tűzállóságát, és emelte a CK lap tűzvédelmi besorolását B-s1, d0 osztályról A1-re, 5% -os vízüveg adalékanyaggal, valamint 20 %-os PDDA + MM adalékkal és az így készült CK lap vízüvegoldatba merítésével. A fa-cement keverék jellemzőit XRD-vel és SEM-mel vizsgálva azt tapasztaltuk, hogy a hidratált keverékben csak a megszokott fázisok jelentek meg, és nem jöttek létre új kristályos fázisok. A dinamikus mechanikai elemzés azt mutatta, hogy a hőmérséklet negatívan befolyásolja a CK lapot. A nagy tárolási modulus nagy hajlítószilárdsággal párosul és fordítva. Mindkét fafaj esetében a nyáralapú panelek nagyobb veszteségmodulussal rendelkeznek, mint a fenyőalapú panelek, amelyek nagyobb rugalmasságot jelentenek.

## CHAPTER I

### 1. Introduction

#### 1.1 Background

Over the years, many aspects of building construction have improved, from design to construction materials. There are many well-known kinds of construction, wood construction, masonry, concrete and steel frame construction, etc. For wood construction, the buildings are light and warm during winter depends on the used system. Wood as construction material has a good resistance to tensile forces, but its resistance to fire not the best since fire resistance of wood is a complex issue [1]. Concrete buildings are heavily constructed and often are tall. Their resistance to fire is excellent, but the opposite is true for tensile strength, which is considered very small and, in most cases, neglected. Thus, steel reinforcements are used in concrete structures to impart solid bending and tensile force resistance and to protect buildings from seismic activity [2]. For compression strength, concrete is excellent because of the aggregates it contains [3]. The problem with concrete is that it takes 28 days to reach its maximum strength, and water causes corrosion of the reinforcement steel in case of insufficient concrete coverage [4], [5] making buildings weak over time. In addition, cracks are a common problem in concrete [6]. Cement wood composites (CWC) are construction material composed of cement and wood.

#### 1.2 Cement wood composites (CWC)

A composite is a complex material of at least two different components produced to generate specific properties. Wood particles and fibres are suitable raw materials for the creation of enormous types of composites. Cement wood composites CWC are wood composites that have many influencing factors. The significant factor in CWC production is the compatibility between wood and cement. Wood species are the influencer on cement-wood compatibility because of the difference in extractives quantity like sugar and tannin. The time of harvesting, age, and storing are some factors that determine the number of extractives within the wood [7].

In many studies, pre-treatments for wood decreased the number of extractives or cement inhibitors. The most frequently used wood pre-treatments were hot and cold water, sodium hydroxide, calcium hydroxide, and alkaline hydrolysis. These pre-treatments can change the cement wood compatibility from non-compatible to suitable.

The most researched topics are mechanical properties and reduction of the curing time for CWC. Usually, mechanical properties increase by using various additives like calcium chloride and sodium silicate. Carbon-dioxide (CO<sub>2</sub>) decreases the curing time and improves mechanical properties and water absorption of the CWC. There are several different types of CWC: cement fibreboard, cement-bonded particleboard (CBPB), wood-wool cement boards (WWCB), and building blocks.

### 1.3 Problem statement and settings of the investigations

Cement bonded particleboard (CBPB) has a growing market in central Europe. Requirements and regulations on both the global and national levels are forcing continuous developments. Over the years, researches improved the hygroscopic and mechanical properties and shortening the manufacturing time of CBPB via pre-treatments and additives. However, there was no effort to the improvement of fire resistance properties.

A few research projects have examined the fire resistance of CBPB, it was focused on additives' effect on the thermal stability of the material and proving that CBPB is a non-combustible material, however no attempt on improving fire resistance. Nevertheless, the fire resistance of CBPB needs improvement, especially that CBPB is a construction material where fire protection is becoming more and more Substantial in the case of a construction materials like CBPB.

Fire buildings causes human and materials losses. According to the Center of Fire Statistics (CFS) of International Association of Fire and Rescue Services (CTIF) report N°23, containing fire statistics of many CTIF countries and their larger cities for 2016, in 39 country, 3 fire starts each min leaving 18 thousand deaths. In statistics on fire reveal that in hungary in 2016, 17534 fire occured consequencing 114 death and 811 fire injuries, the majority of these death occured within buildings [8]. Acoording to building codes regulations the fire safety in buildings is defined in two areas „reaction ” to fire and „resistance ” to fire. Resistance to fire concern the load bearing capacity, integrity and insulation properties. In other hand, reaction to fire deals with surface lining materials. Reaction to fire is early stage of fire development which is connected to many parameters such as: ignition, flame spread, heat release and smoke propagation. European fire testing of construction products is based on the euro class system with the following standardized tests:

- Fire technical testing of building products – non combustibility: EN ISO 1182
- Fire technical testing of building products – single burning item test (SBI): EN 13823

- Fire technical testing of building products – ignitability test: EN ISO 11925-2

Euro class requirements for building materials are A1, A2, B, C, D, E and F. Smoke production and the formation of flaming droplets are expressed with the additional classes s and d. The smoke production classes are s1, s2 and s3, and the formation of flaming droplet classes are d0, d1 and d2 [9].

Where,

- A1: Products will not contribute at all to the fire.
- A2: Products will contribute in the fire to an extremely limited extent.
- B: Products will contribute in the fire to a very limited extent.
- C: Products will contribute in the fire to a limited extent.
- D: Products will contribute in the fire to an acceptable extent.
- E: Products' reaction to fire performance is acceptable.
- F: No reaction to fire performance is determined.
- s1: The smoke production is very limited.
- s2: The smoke production is limited.
- s3: The smoke production does not meet the requirements of class s1 or s2.
- d0: No flaming droplets or particles occur.
- d1: The flaming droplets or particles extinguish quickly.
- d2: The formation of flaming droplets or particles does not meet the requirements of class d0 or d1.

Fire resistance of composite materials is major problem because of public safety. Thus, it is preferable to understand how individual components of the end-products burn and what best method to modify materials and make them flame-resistant without influencing their valuable properties like low weight or high mechanical ratios. CBPB contain two materials cement and wood. In case of cement, it is inflammable material while wood can burn easier, that means in order to improve fire resistance of CBPB, wood fire resistance must increase.

Materials in general including wood do not actually burn, but combustion takes place as a reaction between oxygen and the gases released from a material. Under the effect of heat, wood produces easily substances that react eagerly with oxygen, leading to the high propensity of wood to ignite and burn. Ignition and combustion of wood is occurred because the thermal decomposition (pyrolysis) of cellulose and the reactions of pyrolysis products with each other and with gases in the air, usually oxygen. Untreated wood chars with speed of 1 mm per min, to

improve the fire resistance of wood, fire retardant treatment can be a solution because fire retardants have many characteristics that can deal with the above-mentioned parameters of first stage fire development [10].

The fire or flame-retardants are created to decrease the material temperature. When ignition occurs, the flame-retardants create thermal degradation while raising the amount of char and reducing the flammability [11]. Fire retardants have two kinds of actions: physical and chemical. For the physical action, there are many ways to delay ignition. Cooling is one method, where fire retardants can decrease the materials temperature. Coating is another way of delaying ignition where fire retardants can form a protective layer that prevents the underlying material from combusting. Dilution is the third way in which the retardants release water and carbon dioxide during burning. Each fire retardant has a better effect on a specific kind of material, so the choice of fire retardant depends on the substrate and its unique set of characteristics.

CBPB is composite material within the B-s1, d0 classification of fire resistance (MSZ EN 13501-1:2007+ A1:2010) [9], [12]. Using fire retardants as pre-treatments for wooden particles used in the CBPB could upgrade it to the A2 or A1 classification, because wood combustion occurs when wood molecules (cellulose, hemicellulose and lignin) decompose, fire retardants can modify these wood molecules and make it more fire resistance. However, fire retardants should not affect the primary properties of CBPB such as mechanical properties. Nevertheless, the used fire retardants have to be eco-friendly and cheap because the CWC has to remain on budget. Phosphorus, boron compounds, and polyethylene glycol seem potential pre-treatment wood fire retardants, because of cheap price, eco friendliness and effectiveness on fire retardation of wood. The main goal of this research work is to improve the fire resistance of CBPB with fire retardants pre-treatments. This research makes good contribution to both scientific and industrial field because, from scientific point of view, it's the first research discussed new perspective on enhancing CBPB by increasing its fire resistance properties with fire retardant pre-treatments. It should be noted that such a research work is very much needed for other scientists because it indicates directions for further possible research which is fire retardancy of CWC. In other hand, from industry point of view, a widely used construction material (CBPB) will be developed, that will help to build more fire resistance constructions. Each study has its limitation which researcher has no control, in this research case, the water uptake during cement wood curing process cannot be measured because of the water content in wood. Several objectives are defined to achieve the main goal.

***Objective I: define the influencing factors on the fire retardations performance.***

The objective of this part of the research work was making pre-tests to investigate the efficiency of the selected fire retardants: Disodium-tetra borate (Borax), Diammonium Hydrogen Phosphate (DAHP), Disodium Hydrogen Phosphate (DSHP) and polyethylene glycol with molecular weight 400 (PEG 400) on the chosen wood species, which are Scots pine (*Pinus Sylvestris*) and a poplar hybrid (*Populus cv. euroamericana I214*).

Fire hazard has two aspects: the fire spread and smouldering. Fire retardants (FR) has two categories: the first type suppresses the fire spread, while the second type prevents the smouldering. In order to understand the type of the used FRs three-fire test were selected. The single flame source test to investigate the fire spread, Lindner and calorimeter test to check the smouldering. However, the behaviour of the FR on the selected wood species can be influenced by many factors like surface roughness of the wood species, the concentration and wettability of the used FR's. This why all tests were made with differently machined wood specimens and FR's were prepared with different concentrations.

***Objective II: examine the validity of the hypothesis “good wettability gives good fire retardancy”***

Contact angle measurement is a method to measure the wettability of fire retardants on wood. According to the literature, droplets of distilled water (DW) and diiodomethane (DM) used in contact angle measurement. However, in this study, the fire retardants themselves are used as test liquids. Since there was no data (Liquid tension) on the used fire retardants, the wettability was evaluated based on the droplet spread on the wood surface. Based on wettability and fire test results conclusion was made on the validity of the hypothesis “good wettability gives good fire retardancy”.

***Objective III: Effect of Fire retardants on Cement curing.***

Improving fire resistance of CBPB with fire retardants pre-treatment is a new research topic which not done before, no literature found on the effect of fire retardants on cement curing. A hydration test was applied to evaluate fire retardants' influence on the cement curing within 24 hours.

***Objective IV: production of CBPB made of treated wood particles of Scots pine and poplar.***

Cement bonded particleboards produced by Scots pine and poplar pre-treated particles with fire retardants (Borax, DAHP 300 g/l, and DSHP 77g/l) and bonding agents (Sodium silicate (SS) and Polydiallyldimethylammonium chloride+montmorillonite nano-mineral (PDDA+MM)). In total,

32 different CBPB's were prepared 8 are control specimens with untreated particles. The concentration of DAHP reduced to 150 g/l as cement did not harden with 300 g/l.

***Objective V: Investigation of the effect of fire retardants on the CBPB properties and compare them to the standard requirement.***

After 15 days from CBPB's curing, specimens were prepared with the required dimensions for each test and tested with Standard tests to investigate the effect of the FR's on the CBPB properties and if produced boards meet the standard requirements. The following tests were conducted, modulus of elasticity in bending and bending strength (Bending test) EN 310[13], internal bond (IB) EN 319 [14] and swelling in thickness after water immersion [15].

***Objective VI: Compare the Fire resistance of the produced CBPB to the EN standard classification.***

The flame spread on the specimen's surface was observed by a single flame source test EN ISO 11925-2 [16] Also, a non-combustibility test EN ISO 1182 [17] made to determine whether the produced CBPB's will participate directly to fire expansion or not and the possibility that the produced CBPB's upgraded according to the classification of building products into classes A1 and A2 because the conventional CBPB classified within B-s1, d0 classification [12].

***Objective VII: Comparison of the thermal and mechanical characteristics of the produced CBPB's and the effect of fire retardants treatment on the cement wood mixture curing.***

Each fire retardant had a different effect on the CBPB's curing leads to a need to study cement wood mixture. Scanning Electron Microscopy (SEM) observation was carried out to identify the crystalline phases in the cement mixture of CBPB and observe the compatibility between cement paste and wood particles. Fire retardants may lead to the creation of new crystalline components in cement paste. X-ray diffraction (XRD) was conducted to identify the new crystalline phases created by the fire retardants. Thermal and mechanical characteristics comparisons were also made on each CBPB by Dynamic Mechanical Analysis (DMA) and Thermal Gravimetric Analysis (TGA) tests.

## **1.4 Dissertation structure**

To make this research work easy to present and follow, the dissertation consists 5 chapters, which are:

### ***Chapter I: Introduction***

In this chapter, general introduction with presentation of CWC was given to help non expert reader to understand this topic, followed with statement of the problem and importance of the research work to the scientific and industry field. Solution was given with the objectives in order to achieve the main goal.

### ***Chapter II: Literature Review***

In first part of the chapter, research works on CWC were summarized with the focused on the last 10 years published papers to draw idea on the researcher focused on this scientific field of research and the missing point. After that problematic was pointed out with its characteristics and description of solution was provided. Later, Theories on enhancing wood fire resistance was made with the influencing effects and characteristics.

### ***Chapter III: Materials and Methods***

This chapter contains over all description of the materials and methods used in the research work, it is divided to two parts, where first part consists primarily test, where all test were made on pure wood (Scots pine and poplar) with fire retardants to investigate fire retardants fire resistance performance on selected wood species and their effect on cement curing. Second part, contains the experimental tests on the produced CBPB's.

### ***Chapter IV: Results and Discussion***

The fourth chapter is a presentation of results, and a general discussion. It is spitted to two parts, where first part discussed the primary tests results and based on that results fire retardants and their concentration and way of application was selected. In the second part hygroscopic, mechanical and fire properties of the CBPB's were analysed and discussed.

### ***Chapter V: Conclusion***

After compiling and analysing the results and discuss it, a conclusion was created to describe all achieved results during this work.

## CHAPTER II

### 2 Literature review

#### 2.1 Background

Current research has focused on the cement-wood composite. This product has advantages of both concrete and wood, its resistance to fire is better than that of wood and its tensile and bending strength is better than concrete, and it is also lighter. In cement-wood composites, the cement is reinforced by wood fibres, particles, flakes, and wood-wool with different shapes and sizes [18]. Cement-wood composites need 24 hours to cure and reach maximum strength. As it is lighter than concrete, this type of material is easy to use, equating to time and money saved. These composites are usually used as insulation material or construction material [19]. For construction, cement-wood composite is used as panels, and in some recent studies cement-wood composites were used in the main structural elements of buildings, such as beams [20], [21]. Because of the CWC strength properties, it is usually used for interior and exterior applications and for acoustic properties (*e.g.*, highway sound barriers) [22]. Gunduz *et al.* [23] stated that cement-bonded particleboards are effective as acoustic outdoor noise barriers.

The most well-known cement bonded products are cement fibreboard, cement bonded particleboard (CBPB), wood-wool cement boards (WWCB), and building blocks [24]. Low density boards are used as thermal insulation [21]. One of the important aspects of making cement-wood products is the ratio of the used materials, which are the ratios of wood/cement and cement/water [25]. Compatibility of the wood and cement is important because wood may contain compounds that affect the curing of cement. Curing agent additives are used to solve this problem and make the cement cure in less time.

In most cases, Portland cement is used. Not all wood species exhibit good bonding with cement because each species has different structures and chemical compositions. While the kind of wood is important, the place of growth and age can make a difference [21], [26], [27]. This is why lots of research has been carried out over the years on this topic with different wood species, kinds of cement, and curing additives, to produce different kinds of cement-wood composites with improvements for many different uses.

Wood cement composites are one category of the mineral-bonded products. The inorganic-

bonded materials first appeared in the early 1900s with gypsum-bonded wood shavings board. In 1910 magnetite-bonded wood board was produced with an approximate density of  $400 \text{ kg/m}^3$ , and it were developed in Austria in 1914. Such low-density boards are usually used as insulation panels [28]. Cement wood composites appeared in 1920, by manufacturing wood-wool cement board (WWCB) with density of  $400 \text{ kg/m}^3$ . This was followed in 1930 by development of wood chips cement board having a density of  $600 \text{ kg/m}^3$ , but in that year there was no strong demand for wood cement panels for industrial applications. In 1960 coarse wood particle cement board was made with a density range between  $500$  to  $700 \text{ kg/m}^3$ , but in 1970 cement-bonded particle board (CBPB) was developed with very high density  $1250$  to  $1400 \text{ kg/m}^3$ . In order to replace asbestos-cement board for structural applications, CBPB was commonly used in Europe for facades, floors, fire, and moisture-resistance furniture [28]. Between the 60's and 70's most of researchers focused on the effect of cement/wood proportion on Wood Cement Product properties; the results of such work was widely varied because of the used particle geometry, treatments, wood species, panel density and many other factors [29]. In 1990, the cement wood-wool board products were further developed, and their density increased to  $900 \text{ kg/m}^3$ . With the beginning of the 21st century in 2000, wood strand cement board (WSCB) were produced with a density of  $1000$  to  $1100 \text{ kg/m}^3$  [28].

The shape of the wood used, i.e. fibres, particles, chopped strands, flakes, or wood-wool has an effect on the mechanical properties and utilisation of cement-wood composite products [30]. There are several different types of wood cement composites, as shown in Fig.2.1.

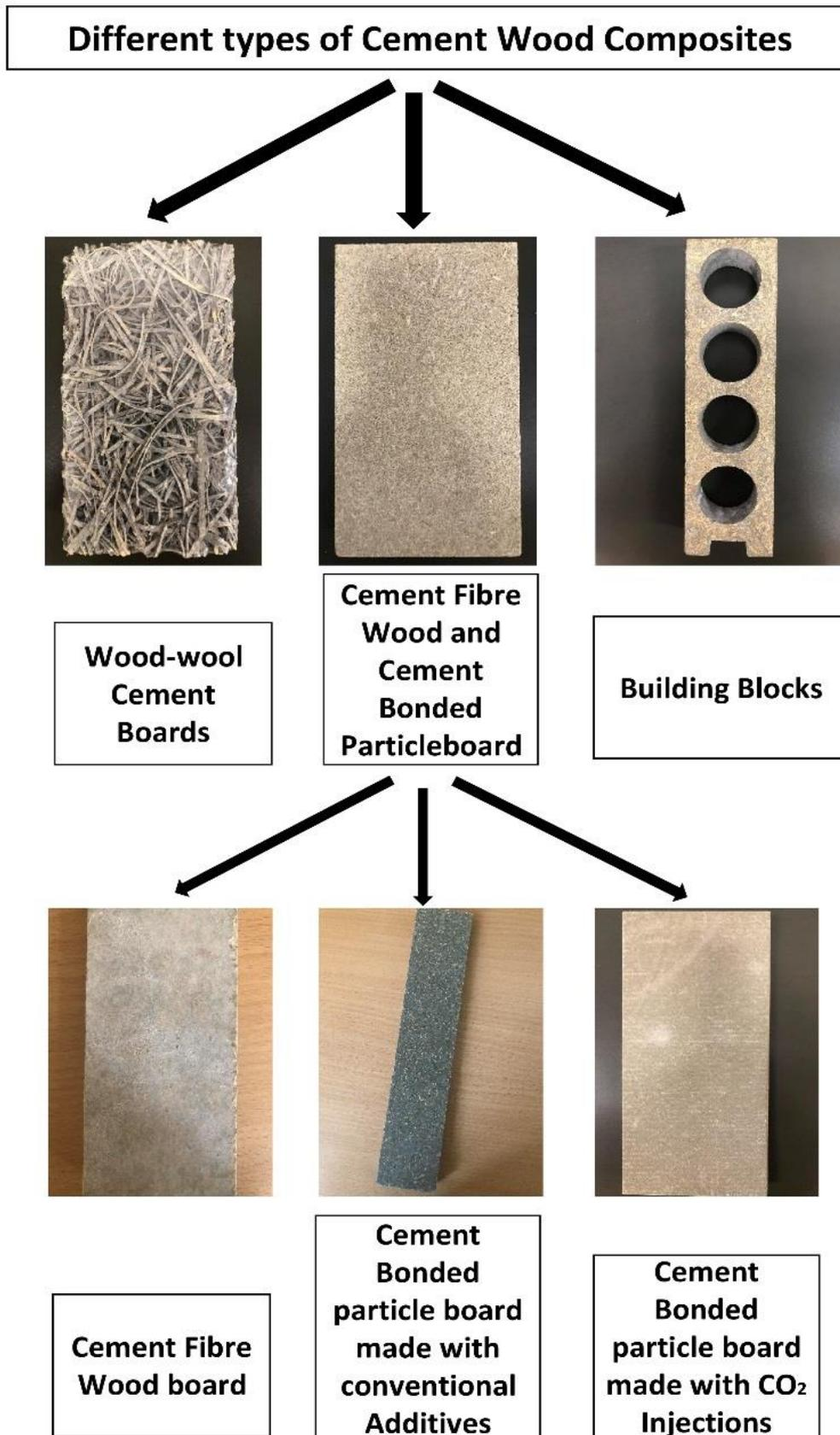


Figure 2. 1: Schematic diagram of different types of Cement Wood Composites (CWC).

### **2.1.1 Cement fibre wood and cement bonded particleboard (CBPB)**

Cement fibre wood and cement-bonded particleboard usually are produced from fibres and particles of wood with different sizes and shapes [31]. These kinds of boards have good mechanical properties and high weight compared to other cement-wood composites because it has higher density. In recent years, extensive investigation on the possibility of manufacturing particleboard from wood waste has been undertaken. In several studies, CO<sub>2</sub> was used as a curing agent for cement particleboard production utilising construction wood waste particles [32], [33]. Ashori et.al, produced boards using waste wood from railway sleepers. The mechanical and physical characteristics of board increased when using CaCl<sub>2</sub> or calcium chloride [34]. Wang et al, used construction wood waste to produce water resistant magnesia-phosphate cement particleboards by using red mud and alumina. The results were satisfactory and proved that red mud and wood waste are possible materials for manufacturing particleboard [35]. The manufacture of cement particleboard from upcycled wood waste, reinforced by magnesium phosphate, has been investigated. The mechanical characteristics, thermal properties, and water resistance of the board improved [36].

### **2.1.2 Wood-wool cement boards (WWCB)**

Wood-wool cement composites are manufactured from Portland cement and wood-wool [37]. The fabrication of wood-wool board demands specific particle dimensions. The length varies between 25 and 500 mm, the width from 0.5 to 5 mm, and thickness from 0.03 to 0.64 mm [38]. This product has impressive mechanical and chemical properties; however, it is hard to understand why its mechanical properties are so excellent [37]. Usually wood-wool cement boards are used for insulation purposes. Alpar et al, showed increased bonding between the Portland cement and wood, which improved the product. Additives were used to change the wood fibre surface [26].

### **2.1.3 Building blocks**

These types of products function well as building construction materials. Building blocks have been manufactured by using cement as an adhesive for wood particles. As example, in Washington state, blocks that were 203 mm thick, and either 305 by 610 mm or 305 by 1280 mm, were produced; however, thickness and height could vary. The biggest blocks weighed 45.5 kg [38]. Building blocks have good resistance to fire and excellent insulation characteristics. Regarding density, they are like soft wood hence easy to nail and sand. The advantage of building blocks is that they are easy to manufacture [38].

## 2.2 Mechanics of Wood and Cement Bonding

### 2.2.1 Cement hydration

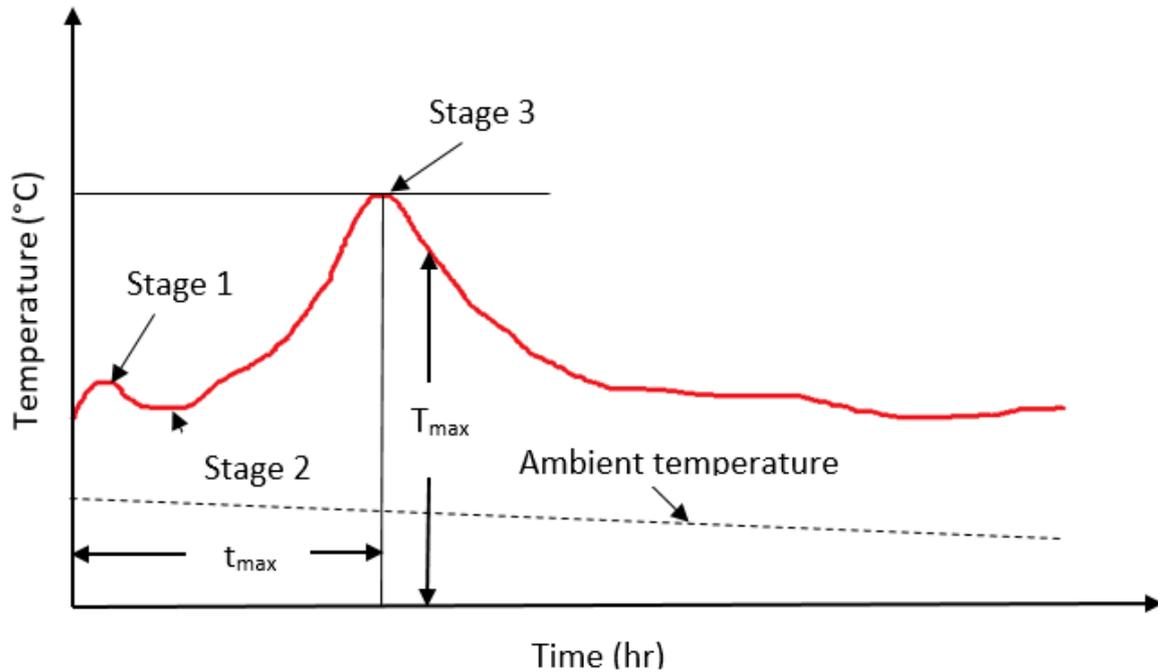
Portland cement is the most used cement in Wood cement composites. It is a combination of materials heated in a kiln in specific temperature then grinded to make a cement powder [1], [3]. The Portland cement is 90 % clinker and a small amount of gypsum or calcium sulphate dihydrate ( $\text{CaSO}_4 \cdot 2\text{H}_2\text{O}$ ), magnesium oxide (Magnesia) and other minerals, which improve cement characteristics and help the hydration process. The composition is different for each of the five types of cement (See Table 2.1) [3], [39]. The cement types are introduced by CEM followed by Roman number refer to the main sort. After that there follows by the cement strength number and a capital letter refer to a class of cement like N or R. N refer to ordinary early strength, R refer to high early strength. Example: CEM I 42.4 N.

**Table 2. 1:** Types of cement.

Types of cement	Classification	Properties	Purpose of use
CEM I	General application	High C3S content for good early strength development	General construction
CEM II	Moderate sulphate resistance	Low C3A content < 8 %	Structures subjected to soil or water containing sulfate ions
CEM III	High early strength	Ground more finely, may have slightly more C3S	Fast construction
CEM IV	Low hydration heat (slow reaction)	Low content of C3S (< 5 %) and C3A	Big and heavy structures like dams.
CEM V	High sulfate resistance	Very low C3A content (< 5 %)	Structures exposed to high levels of sulfate ions

In the hydration of cement, it reacts with water, giving the cement its strength and making it a hard material [40]. Usually, the compatibility of cement and wood is referred to as the degree of cement setting after mixing it with wood and water. The presence of wood has an effect on the chemical process of cement hardening. Interaction between cement and wood lowers the physical and mechanical properties of the cement composites like thermal insulation, resistance to water, bending and internal bond strength. The inhibitor effect is usually measured by the decrease of the

heat released during the cement curing. The amount of heat released from cement-wood mixture, as well as the heat released from a cement-wood mixture interfaces, is defined as the  $C_A$  factor and is used along with ( $T_{max}$ ), or the period of time needed to reach the maximum temperature.



**Figure 2. 2:** Schematic diagram of typical temperature plot of cement-wood mixture [40].

In a typical temperature plot of cement-wood mixture (Fig.2.2), three parts can be defined. It starts with initial temperature rise followed by the dormant period. At the latter stage, the temperature is almost constant, stagnant, or barely decreases. The last stage is cement hardening where the temperature rapidly increases. Compatibility of cement and wood is divided into three categories: compatible if  $C_A > 68\%$ , moderately compatible if  $68\% > C_A > 28\%$ , or not compatible if  $C_A < 28\%$ . However, the causes of the incompatibility between wood and cement are unclear [41].

During hydration, all the minerals hydrate simultaneously, making cement curing a complicated process. Moreover, it is the main reason that wood and cement bond is very hard. Wood extractives content and type work as inhibitors to cement curing. Wood contains sugars, celluloses, hemicelluloses, and lignin [21], [42]. These substances cause problems during cement curing because they dissolve with the cement compounds, causing changes that prevent the hydration process and make it longer [41]. Kochova et al, studied the effect of saccharides on cement curing. Various organic compounds like fructose, glucose, lignin, sucrose, and cellulose in lignocellulose fibres were added to the cement mixture with Leachate treated fibre. The results

indicated a prolongation in the setting time, and the cement curing took 2 days due to the glucose, mannose, and xylose present in the treated leachate fibre [43].

### 2.2.2 Influence of Wood Species on Cement Curing

Choosing the right wood species depends on the structure (chemical composition) of wood and on the kind of wood-cement composites produced. In addition, wood of the same species can have different characteristics because of the place of growth, age, and season of felling the tree. The content of sugars and extractives are different between wood species [44]. Thus, it is important to choose the right wood species, additives, wood/cement ratio, and the ratio of cement to water because the amount of sugars and extractives affects the cement hydration process [25]. The most common wood species used in CWCs are poplar, Scots pine [7], [19], [45] and spruce. Spruce is one of the best species for wood-cement composites because it contains small amounts of extractives [38]. Fan et.al, created CWC from 15 tropical wood species to investigate their compatibility with Portland cement. The hemicelluloses and carbohydrates of low molecular weight worked as inhibitors for cement hydration in the cement-wood mixture. With an increase in wood ratio, the compatibility between cement and wood decayed at different rates depending on the wood species. Species in decreasing order of compatibility of wood and cement can be listed as sapele 97 %, nkanang 85 %, mvingui 77 %, padouk 68 %, eyong 64 %, tali 50 %, iroko 22 %, bete 21 %, maobi 17 %, and doussie 10 %. With the increase in solubility content of tropical wood, the compatibility factor increased [44].

Castro et.al, [46] investigated the compatibility of cement with the following wood species: *Eshweilera coriacea* (Er), *Swartzia reanva poepp*, *Manilkara amazonica* (Ma), and *Pouteria guianesisaubl* (Pg). These wood species are suitable for CWC production because they had no inhibitory effect on cement hydration and all wood species had a good compatibility factor  $C_A = 85\%$  for Ec,  $74.4\%$  for Sr,  $85\%$  for Ma and  $76.4\%$  for Pg. The CWC samples reached their maximum mechanical and physical properties after 28 days. Antiwi- Boasiako et al, examined the suitability of various tropical wood species for CWC. *Triplochiton sclerosylon*, *Entandrophragma cylindricuim*, and *Klainedosca gabonensis* sawdust were used in CWC production. After studying the chemical constituents, their composition, and physico-mechanical properties, *Triplochiton sclerosylon* had the lowest extractives with  $6.12\%$  of the total extractives,  $29.89\%$  lignin, and  $56.38\%$  holocellulose. It achieved the highest MOR among the used wood species with  $696.1\text{ N/m}^2$ , and it had a moisture absorption value of  $8.8\%$  [47]. Wang and Yu examined the compatibility of two fast growing species, Chinese fir and poplar, with Portland cement. Results

of hydration test showed that Chinese fir has better compatibility with cement than poplar with  $C_A = 95\%$  while poplar has  $C_A = 24.3\%$  [48]. Al-Mefarrej [49] tested the compatibility of five Saudi wood species: lebeck, button wood, council tree, leucaena, madras thron, and Scots pine with cement. It was found that compatibility factor  $C_A$  differed from one wood species to another. Results were as follows: 17.7 % for lebeck, 52.0 % for button wood, 23.0 % for council tree, 19.0 % for leucaena, 19.9 % for madras thron, and 59.0 % for Scots pine.

Papadopoulos [50], investigated CBPB made from hornbeam wood. Hydration tests showed that the mixture of cement and hornbeam wood had a moderate inhibition, and two different wood cement ratios, 1:3 and 1:4, were applied. Examination of the board properties confirmed that, except for MOR, all properties improved after increasing the cement to wood ratio. After exposing, the CBPB to different fungi, the boards were not affected.

Differences occur even with the same wood species. Kochova et.al, [51] studied wood degradation and its influence on cement-wood compatibility. Two almost identical spruce wood-wool fibre batches were used. The trees were planted, grown, and harvested under the same circumstances. A comparison between the two wood tries was made and results indicated that their compatibility, mechanical strength, and the anatomical structure is different. The percentage of extractives was also different, as one of the species had more extractives than the other, leading to its incompatibility with cement, and effecting the mechanical properties as well.

Storing the wood had an effect on the cement wood compatibility because blue stain or other fungi may attack wood, which leads to an increase in wood extractives. Pascal et.al, [52], studied the compatibility of mountain pine beetle and killed lodge pole pine with Portland cement. A number of factors were involved in the experiment, including the tree's time of death, sapwood blue stain, white rot, and brown rot. Heat rate, total heat release, and cement hydration were measured and results showed no difference between fresh and dead mountain pine beetle and killed lodge pole pine. The only incompatibility occurred in case of specimens with white rot; in all other cases, excellent physio-chemical properties were found. The mixture of cement and blue stained sapwood achieved the highest compatibility.

Based on the cited findings related to the compatibility of wood species and cement, wood species has huge impact on the quality of the CWC. Wood species divided into three categories according to their  $C_A$ : suitable A such as *Eshweilera coriaceae*, *Swartzia reanva* poepp, *Manilkara amazonica*, and *Pouteria guianesisauhl*, sapele, nkanang, mvingui, Chinese fir, spruce, and

mountain pine beetle killed lodgepole pine. Moderately suitable (B) woods included Scots pine, padouk, eyong, tali, lebbeck, madras thron, and hornbeam. Not suitable woods (C) included iroko, bete, maobi, doussie, button wood, council tree, leucaena, and poplar.

### 2.3 Effect of Pre-treatments on Compatibility of Cement and Wood

Because wood extractives inhibit cement curing, several studies were conducted to find pre-treatments that reduce the inhibitors in wood, resulting better compatibility between wood and cement. In most cases, pre-treatment by cold and hot water is applied.

Research was carried out on the compatibility of Portland cement and midribs of date palm (*Phoenix dactylifera* L). Wood particles were subjected to cold and hot water treatment to enhance the compatibility. Results showed that untreated wood particles are not suitable for the CBPB, but the compatibility was enhanced with the treatment. Hot water treatment was classified as suitable and the results also showed that an addition of 3 %  $\text{CaCl}_2$  enhanced the cement wood compatibility under limited conditions:  $T_{\max} = 54.23$  °C and  $C_A = 75.73$  % [53]. In 2014, a study was made on the compatibility between Portland cement and pre-treated *Eucalyptus benthamii* wood. Five types of pre-treatments were used: hot water, cold water, sodium hydroxide,  $\text{CaCl}_2$ , and calcium hydroxide. Results indicated that the inhibition effect of the species decreased by 3 % when using  $\text{CaCl}_2$ , which was the best result. In contrast, the compression strength (CS) increased by mixing  $\text{CaCl}_2$  with carbonated particles through calcium hydroxide [54]. A study was conducted by Quiroga et.al, [19] regarding the influence of wood treatment on the mechanical properties of WCC. Portland cement and (*Populus euroamericana*) were used as materials while water extraction, degradation by alkaline hydrolysis, and retention of inhibitory substances were used as wood treatments. Alkaline hydrolysis was the most effective treatment among the studied treatments for suppressing the inhibitors. However, it resulted in the highest decrease in the mechanical properties of the CWC.

Ferraz et.al, [18] evaluated the chemical compatibility of Portland cement and coir. Cold water, hot water, sodium hydroxide, and  $\text{CaCl}_2$  were used as pre-treatments. Lignin and holocellulose were inhibitors for cement hydration, but adding a mixture of NaOH and  $\text{CaCl}_2$  lowered the inhibition. Jiang et.al, [55] researched the effect of modification methods on the compatibility of poplar leaf fibre and cement. Five methods were used to enhance the compatibility of leaves. The compatibility of leaves and cement can be improved by three methods: dipping the leaf fibre in water, spraying it with sodium silicate, or pare acrylic polymer emulsion. Xie et al,

[56] studied the effect of pre-treatment of rice straw on cement curing. The rice straw was pre-treated in different ways: untreated, steam exploded, once bleached, and twice bleached. The pre-treatments abolish the amorphous hemicellulose and lignin. In addition, they improve the cement crystallinity and enhance the thermal stability of the rice straw fibre.

Nasser et.al, [57] investigated the possibility of making high quality CWCs using tree clipping waste. Different wood species were used, including *Acacia salicina*, *Conocarpus erectus*, *Ficus altissima*, *Leucaena glauca*, *Pithecellobium dulce*, and *Tamarix aphylla*. The wood clipping waste was treated with hot and cold water and  $\text{CaCl}_2$ ,  $\text{Al}_2(\text{SO}_4)$ , and  $\text{MgCl}_2$  were used to accelerate the cement curing and enhance compatibility. Results indicate that the wastes could be introduced into the cement wood composite production as an alternative to wood but along with the application of pre-treatment and adding 3% of the additives  $\text{CaCl}_2$ ,  $\text{Al}_2(\text{SO}_4)$ , and  $\text{MgCl}_2$ . Cechin et.al, [58] studied the compatibility between masso bamboo and Portland cement. The selected wood species were subjected to various pre-treatments such as cold water, hot water, sodium hydroxide, sodium silicate, silane, and calcium chloride. Results indicated that mosso bamboo particles had good compatibility with cement making them suitable for CWC production. Mechanical properties, compatibility, and crystallinity of the produced boards were all enhanced by the used pre-treatments.

Castro et.al, [59] conducted studies on the correlation between the chemical composition of wood and the cement/wood compatibility. Portland cement II-Z and eight different tropical hardwoods from Amazonia were used for the experiments. No correlation was found between polar and non-polar soluble extractives and cement set inhibitors with the exception of *swartzia reauva* with arabinose content. In addition, a correlation was found between *larix* with alkaline solution and cement inhibitors. Lignin and hemicellulose created high amounts of degraded polysaccharides, which cause cement inhibition. Five of the used wood species, *Eschweilera coriacea*, *Inga paraensis*, *Ingalba*, *Ponteria guianesis* and *Byrson imagrispa* had low inhibitory effect.

Table 2.2 presents the compatibility factors of different wood species with different commonly used pre-treatments. The  $C_A$  factor was increased by using pre-treatments upgrading wood species from non-suitable to moderate suitable or suitable, but in some cases such as the doussie wood species the pre-treatments has no effect on increasing the cement wood compatibility. Pre-treatments have different effect on each wood species. In most cases hot water and  $\text{MgCl}_2$  were found to be excellent pre-treatments, but it had no effect on date palm.

**Table 2. 2:** Effect of Different Pre-treatments on the Compatibility Factor  $C_A$  (%) of Different Wood Species.

Wood species	Pre-treatment's solutions ( $C_A$ %)						References
	None	Cold water	Hot water	CaCl <sub>2</sub> 3 %	MgCl <sub>2</sub> 3 %	Ca(OH) <sub>2</sub>	
Chinese fir	95	98.8	100	-	-	-	[46]
<b>Poplar</b>	24.3	63.4	78.3	-	-	-	[46]
Lebbeck	17.7	42.4	48.0	73.9	81.3	-	[47]
Button wood	52.0	77.8	82.6	87.4	90.7	-	[47]
Council tree	22.7	65.1	62.9	77.7	76.4	-	[47]
Leucaena	19.0	69.9	61.3	70.4	67.0	-	[47]
Madras thron	19.9	62.4	60.7	70.4	67.0	-	[47]
<b>Scot's pine</b>	59.0	81.7	86.4	90.5	92.4	-	[47]
Moabi	17	-	92	91	-	95	[41]
Iroko	22	-	52	36	-	66	[41]
Bete	21	-	32	30	-	43	[41]
Tali	50	-	77	86	-	88	[41]
Doussie	10	-	8	8	-	8	[41]
Date palm	27.8	27.8	68.7	75.8	28.3	-	[51]
European redwood	78.5	81.7	86.4	90.5	92.9	-	[51]

#### 2.4 Effect of Additives and Wood/Cement Ratio on Properties of CWC

Because CWCs are widely used construction materials, their properties are very important. Much effort has been focused on enhancing CWC properties. The wood/cement ratio is one of the foremost influencing factors on CWC [50], [60]–[63]. Many additive agents were also utilised on CWC as accelerating agents during the hydration process [21] which worked on bonding the cement and wood, resulting in improvements in the CWC properties. The most frequently used additives were water glass ( $\text{Na}_2\text{SiO}_2$ ), calcium chloride ( $\text{CaCl}_2$ ), aluminium silicate ( $\text{Al}_2(\text{SO}_4)_3$ ), and magnesium chloride or  $\text{MgCl}_2$  [26]. [64]. Some past research works focused on the injection of carbon dioxide, which was also utilised to help the cement wood bonding.

Ashori et al, conducted research on cement-bonded particleboard produced from poplar strands. The wood ratio had an effect on the mechanical and absorption properties of the boards.

They became stronger and denser when made with 40 % poplar strands, while also achieving the best bending strength. Mechanical and water absorption properties were improved by adding 7 % calcium chloride, or  $\text{CaCl}_2$  [61].

Sotande et al, investigated CBPB made from *Afzelia* African wood. Boards were produced using different additives, cement content, and wood shapes, namely flacks, flacks with saw dust, and saw dust. Increasing the cement content in the wood-cement mixture from 1:2 to 1:3.5, and adding chemical additives decreased the thickness swelling by approx. 60 % and water absorption (WA) as well by approx. 71 %. The density was increased by approx. 23 %, compressive strength was increased by almost 60 %, and internal bonding of the boards by an average of 38 %. Only the MOR was not affected by the cement content and additives. The best results were achieved by adding 2 % of  $\text{CaCl}_2$ . The shape of the wood particles had an effect on the mechanical properties of the boards. The best results were achieved by flacks with saw dust with Internal bond strength (IBS) = 0.50  $\text{N/mm}^2$ , modulus of rupture (MOR) = 11.6  $\text{N/mm}^2$ , and compression strength (CS) = 15.16  $\text{N/mm}^2$ , while the worst results were achieved by flacks, with IBS = 0.37  $\text{N/mm}^2$ , MOR = 9.57  $\text{N/mm}^2$ , and CS = 12.6  $\text{N/mm}^2$ . [65].

Boadu et.al, [62] investigated CWC board made from extracted sawdust of various tropical hardwood species with differing densities: *Triplochiton scleroxylon* (low density), *Entandrophragma cylindricum* (medium density), and *Klainedoxa gabonensis* (high density). The increase in wood ratio causes an increase in the mechanical and physical properties (MOR, shear strength, and thickness swelling (TS)). Boards made from extracted sawdust showed better mechanical properties and resistance to thickness swelling than the boards made from normal sawdust. TS (%) was decreased from control specimens with TS = 1.5 and 2.9 % for *T. scleroxylon* and *E. cylindricum*, respectively to TS = 0.42 and 0.95 %, respectively, with using hot water. Shear strength was increased from 0.3 and 0 to 1.8 and 1 ( $\text{N/mm}^2$ ) for *T. scleroxylon* and *E. cylindricum*, respectively. MOR was increased from 1.8 and 1.1 to 4.1 and 2.4 ( $\text{N/mm}^2$ ) for *T. scleroxylon* and *E. cylindricum*, respectively with using extracted sawdust with hot water. CWC boards having high dimensional stability and mechanical properties were produced from extracted wood sawdust of the selected species.

Matoski et al, studied the influence of various accelerating agents in CWC. It was made from the wood dust of various *Pinus* species and Portland cement. Different additives were used, including calcium chloride, magnesium chloride, aluminium sulphate, and sodium silicate. Results indicated that the chloride additives were able to increase the mechanical properties of the manufactured panel to values above the requirements of the following standards (EN 1058 and

ASTM D 1037) with CS = 18.1 MPa, MOR = 4.72 MPa, and IBS = 0.54 MPa for CaCl<sub>2</sub>, and CS = 18.0 MPa, MOR = 4.55 MPa, and IBS = 0.57 MPa. For the water absorption test, it was found that aluminium sulphate had the best results, with WA = 1.52 % after 2 h of immersion in water and 3.97% after 24 h, creating a waterproof system by increasing the amount of ions reacting with tricalcium aluminate, which is one of the cement components [66].

The effect of the pre-treatments and cement-wood ratio on the CWC has been investigated [60]. *Prosopis chilensis* wood and Portland cement in addition to gypsum as a partial substitution for cement were used for the cement composite production. Cold water, sodium hydroxide, and calcium chloride were used as pre-treatments. CWC were produced with different wood-cement ratios: 2:1, 3:1, 4:1, and 5:1. The best wood-cement ratio was 3:1, and adding 10 % of gypsum as partial substitution of cement improves the compression strength with (51.6 % CS = 51.3 N/mm<sup>2</sup>, while for control specimens CS = 24.8 N/mm<sup>2</sup>). However, adding more than 20 % gypsum effected the compression strength negatively [60].

A study concerning the hydration behaviour of CBPB made from cement and a mixture of wheat straw and poplar. Additives MgCl<sub>2</sub>, CaCl<sub>2</sub>, and Ca (OH)<sub>2</sub> were used with different proportions: 3 %, 5 %, and 7 % based on the cement weight. The straw-wood ratio has a strong influence on the physical and mechanical properties of the CBPB. Among the used additives, 7% CaCl<sub>2</sub> yielded the best results generally for the properties with TS = 13.4 %, IBS = 0.66 MPa, and MOR = 16.87 MPa while also shortening the setting time [67]. Tabarsa and Ashori, [63] investigated the cement wood-wool board by using eucalypt and poplar with Portland cement. Ratios of 40:60 and 60:40 of wood-wool-cement were used, and CaCl<sub>2</sub> was used as treatment. The 5 % CaCl<sub>2</sub> improved the performance of the boards. Wood species is another factor that determines board properties. For example, boards made of eucalyptus had higher water absorption and shrinking swelling Cement composite was made from cement and wood-wool of kelampayan wood (*Anthocephalus chinensis*). As additives, 3 % calcium formate, sodium silicate, and magnesium chloride were used to accelerate the setting time of the CWC. The additives increased the early stage strength and mechanical properties of the boards [68].

Wulf et.al, investigated concrete reinforced by mineralized wood particles as stiffening elements with increasing density. Mixtures of Portland cement and particles of scots pine and spruce were made. To mineralize the wood, various treatments were applied to the wood particles. The wood filler mineralised by water glass (sodium silicate) and Portland cement improved the wood concrete only when using 15 % wood particles as filler based on mass. A density decreases of 36 to 39 % was observed.

## 2.5 Treatment for Accelerating Cement Curing

Reducing the curing time of the cement wood composites has been heavily researched. Makoving, [69] investigated the possibility of drying CWC boards *via* microwave without damage to the boards or decreased mechanical properties. The results indicated the possibility of drying the boards without affecting quality. In recent years, CO<sub>2</sub> treatment is widely used for decreasing the curing time of the wood cement composite and improving its mechanical properties.

### 2.5.1 Carbon Dioxide (CO<sub>2</sub>)

During conventional production, CBPB is pressed between steel plates and left to dry for 24 hours, which is the time needed to become self-supporting. However, carbon dioxide (CO<sub>2</sub>) hardened CBPB in only 5 min bringing in advantages like lower energy requirements and higher production capacity [70]. Qi et.al, [71] investigated the possibility of accelerating the hardening of a wood-cement mixture made of red pine and Portland cement using CO<sub>2</sub>. In the first minutes of using the CO<sub>2</sub> injections, the carbonisation reaction started. After 30 min, approximately 43 % of the calcium oxide content in the cement was carbonated. The rapid hardening may have been caused by the interaction of calcium silicates in cement with CO<sub>2</sub>. On the other hand, no reaction was observed between calcium hydroxide and CO<sub>2</sub>. Wang et.al, [33] used CO<sub>2</sub> curing and fibre reinforcement to accelerate cement curing and enhance the physical properties of particleboard made of cement and wood waste. The results indicated that CO<sub>2</sub> helped cement hydration by accelerating the Ca(OH)<sub>2</sub> transformation into CaCO<sub>3</sub>, resulting in improvements in the strength of the particleboard. In addition, the total pore area of 12.2 m<sup>2</sup>g<sup>-1</sup> was reduced to 10.3 m<sup>2</sup>g<sup>-1</sup> and porosity from 34.8 % to 29.7 %. All the requirements of the relevant international standards were fulfilled by enhancing the mechanical properties, dimensional stability, and contaminants sequestration. Soroushian, investigated the effect of accelerated aging on the bending strength; CO<sub>2</sub> helps increase the CaCO<sub>3</sub> and decrease the Ca(OH)<sub>2</sub> content, which results in higher bending strength and stiffness. As a consequence of aging, CaCO<sub>3</sub> content increases and Ca(OH)<sub>2</sub> content decreases, leading to an improvement in the fiber matrix interfaces. [32].

Increasing the performance of cement wood composite by CO<sub>2</sub> is not always effective. Wood species used can have important effect. Taskirawati et.al, evaluated the characteristics of cement-wood board made of Portland cement and two wood species, *Acacia mangium* (Acacia) and *Arthophyllum diversifolium* (Lento-lento). The boards were made with the conventional production method, using CaCl<sub>2</sub> as an accelerator additive, and boards were also made by the

carbonisation method using CO<sub>2</sub> injection to accelerate the hardening and enhance the mechanical properties. Results showed that the boards made of Lento-lento wood had better characteristics with the CO<sub>2</sub> injection method, while Acacia showed better results with the conventional production method, thereby proving that CO<sub>2</sub> injection is not always better than the conventional production methods depending on the used wood species [72]. Maail, [73] studied the degradation of cement-bonded particleboard made of Portland cement and a mixture of wood species: Japanese cypress (*Chamaecyparis obtusa* Endl.) and Japanese cedar (*Cryptomeria japonica* D. Don) with CO<sub>2</sub> as a curing accelerator. Results indicated the effect of CO<sub>2</sub> on the degradation of CBPB. CO<sub>2</sub> helped the boards to reach the maximum mechanical properties in a short time by accelerating the cement curing process. CO<sub>2</sub> did not just help in accelerating the curing but enhanced the mechanical properties and dimensional stability as well. However, the timing of CO<sub>2</sub> treatment had a big influence on its performance. The treatment is recommended for short period of time, no longer than 30 min. Using the CO<sub>2</sub> treatment for 60 min to 10 days had a negative influence on the mechanical properties of the boards, as longer periods of time cause CBPB degradation because of the effect of the calcium carbonated content [74]. A study was undertaken on cement-wood boards made of Portland cement and date palm with a CO<sub>2</sub> curing accelerator. It was found that date palm fibers are not compatible with cement; however, with hot water pre-treatment, the fibers' compatibility upgraded to suitable. CO<sub>2</sub> injection decreased the bending strength and enhanced the matrix and the board's qualities [75].

Additionally, research was done on CBPB made with various kinds of natural fibers using CO<sub>2</sub> injection to raise the initial compatibility between cement and fibres. The CO<sub>2</sub> injection was successful in increasing the initial strength by accelerating the cement curing and bonding the cement and wood. These boards had similar mechanical properties as the boards made via conventional production, and had a lower cement content [76]. The durability characteristics of composites made of cellulose fibre and cement were studied. After treating the boards with CO<sub>2</sub> results indicated that the capillary porosity decreased due to the CO<sub>2</sub> curing, and the rise of CaCO<sub>3</sub> content increased the compatibility between the cement and fibers by improving the cement-based matrix for cellulose fibers. The longevity and weathering resistance was also enhanced [77].

## 2.6 Fire Resistance of Cement Wood Composite

For building materials, fire resistance is a very important factor because of human's safety. Materials made of magnesium cement products are considered outstanding fire retardant materials

[78]. Generally, cement-wood composites are materials that have good fire resistance. Saval et.al, [79] investigated the flammability of CBPB made of cement and *Oceanic posidonia* waste. Because no flame spread occurred to the CBPB, it is not a flammable material. According to the literature, the cement-wood ratio has an influence on the fire resistance of the cement-wood composites. A study was conducted on recycled Chinese fir particles and cement. The investigation was performed using a cone calorimetry test. Results indicated that the cement-wood ratio had an effect on the fire resistance of the CBPB. With a rise in the cement-wood ratio from 0.5 to 2, the ignition time increased from 26 s to 548 s, and the mass loss rate decreased. [80].

## 2.7 New prospective for CWC enhancement

The upper part of this chapter summarized the world's research achievement, related to CWC over the years with focus on the last 10 years. Many studies have been conducted, that covered many problems such as: enhancing cement wood compatibility, CWC thickness swelling, water absorption, and mechanical properties, as well as reducing its manufacturing time. However, no research showed new prospective on enhancing the CWC. In the course of research, among all the previous papers only a few addressed fire resistances of CWC. All researches dealt with the same above mentioned prospective only the used materials and methods changed. However, there is no research on making it more fireproof. There was no wood pre-treatment investigation improving the fire resistance of CWC, as was the case for reducing wood inhibitors and improving mechanical properties. The only studies in the fire retardation prospective concerned the non-combustibility of the CWC and the effect of wood ratio on its fire resistance.

Fire safety is an important aspect in constructions. Based on statistics in 39 country in 2016, thousands of people died in building fires [8]. Building fires leaves both human and material losses, sine CWC are construction material the increase in its fire resistance will help to build more fire resistance buildings. The aim of this research work is to improve fire resistance of CBPB which will be advantageous for both scientific and industrial field. From scientific side, the idea of enhancing flame retardancy of CBPB will open new research prospective to scientists on CWC while for industrial field a construction material will improve which is good especially that national and international regulations is pushing companies to enhance their products and enhancing fire resistance of construction material will means more safer building to fire. However, to increase fire resistance of CBPB which is a composite material of cement and wood, its better to target the weakest component to fire. Since cement is non-combustible material unlike the wood, increasing wood flame resistance will increase CBPB fire resistance as well. Wood combustion is

a complex process, to improve flame resistance of wood, it must understand the processes of wood burning to find a solution to overcome it.

## **2.7.1 Wood combustion**

### **2.7.1.1 Pyrolysis**

Wood consists of connected atoms to each other in strings of units long, that called molecules, which in case of wood molecules of cellulose, hemicellulose and lignin. The temperature of material is related to the violence of the atomic motion in the molecules. With the raise of the temperature, more vibrations to the atoms occurs. In the end vibration get stronger making the atoms come apart, as a result the molecules begins to separate [81]. Wood pyrolysis is a term called on the decomposition process of wood molecules caused by raise in temperature. The first wood molecule decompose is hemicellulose at temperature range of 250 to 500 °C, after that comes cellulose between 275 to 350 °C, then lignin with temperature of 250 to 500 °C. The thermal stability of lignin is a reflection of its high molecule weight and heavily crosslinked structure [82].

When wood pyrolyzed it create a char layer of carbon and ash that works as barrier for the under lying wood from direct outside heating. Because of wood shrinkage caused when it changes to char, the char layer cracks, giving an opportunity to the produced gazes to escape from the surface layer to the under lying wood [81]. That's the reason that makes the charred surface of wood abstained temperate of 800 °C, while the main pyrolysis of wood is range between 225 to 500 °C [82].

### **2.7.1.2 Char**

When wood pyrolysis forms two kinds of gaseous products: gazes that escape of the solid residue and gazes that don't. Gazes that escapes are sneak from cellulose and lignin in the early-stage pyrolysis process, where its wealthy of oxygen and hydrogen. The gazes that do not escape from solid residue, pyrolysis keep to leak and form a secondary char.

Char formation has significant influence on wood decomposition because the char layer works as shield that slower the virgin wood decomposition process. The char does not increase strength of wood; however, it increases its thermal resistance of the virgin wood under the pyrolysis front. As a result, it causes a reduction in heat release rate and convert to a mass transport barrier for volatiles lunched from fuel and oxygen in the air [82]. The formed char has different structure and amount from wood to another. Usually, the amount of char varies from 20 to 30 °C

of the wood weight. Char basically is carbon with small quantity of hydrogen and oxygen. Carbon structure melt only at high temperature 4000 °C [81].

### **2.7.1.3 Smoke**

Smoke is mostly carbon and ash, in general, smoke forms when big molecules in the pyrolysis gazes reacts with air but are not in complete combustion (insufficient oxygen to burn the wood completely), it condenses to tiny micrometre size droplets [81]. These tiny droplets or particles are invisible to the eye but when they come together will be clear and take form of what called smoke. Wood can produce 25-100 m<sup>2</sup>kg<sup>-1</sup> of smoke in well ventilated conditions [82].

In indoor fire cases, most of people die because of smoke inhalation rather than flames. Smoke not only decrease visibility but diminish the chances of deliverance from a flaming building because it can be extremely toxic, irritating and lethal. Carbon monoxide, carbon dioxide and water are primary products obtained of wood combustion. However, the presence of heteroelements such as nitrogen or halogens can release hydrogen cyanide and hydrogen halides [82].

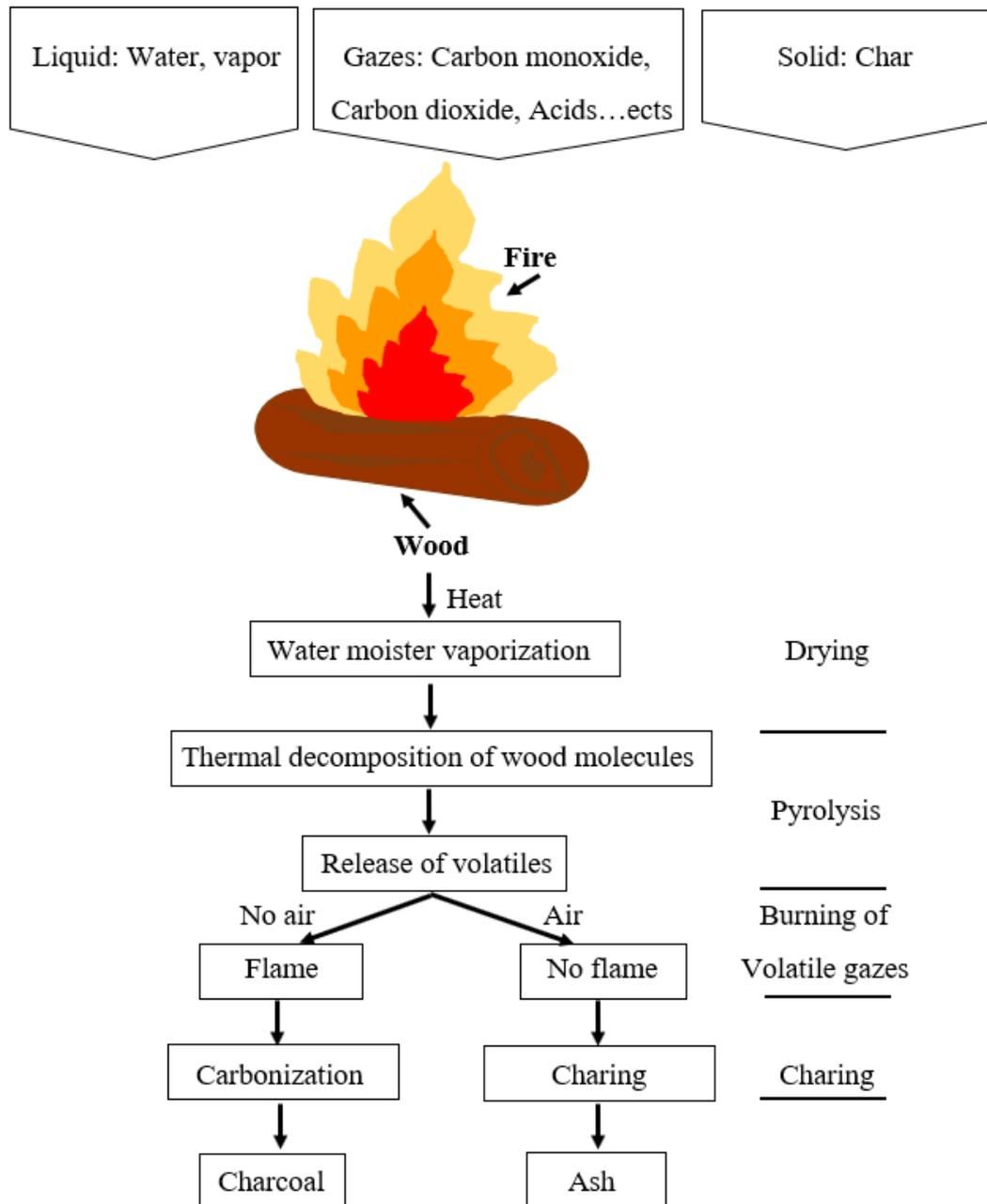
### **2.7.1.4 Solution to overcome the wood combustion problem**

Based on wood combustion process (Fig.2.3), decomposition of wood molecules (cellulose, hemicellulose and lignin) is the reason of wood pyrolysis. the best solution to overcome the problem of wood pyrolysis is to modify the wood molecules with fire retardants. Many chemicals could be used as pre-treatments to improve the fire resistance of the wood and as a result improve fire resistance of the wood-cement composite. Sodium silicate is known as a binder and fire retardant that can improve wood properties such as the mechanical properties, dimensional stability, and fire resistance[68], [83].

Fire retardants have different effects on different materials because each material has a unique response to fire based on a number of factors. For example, the material's ignition ease, rate of burn, and flame spread over the surface are factors to consider. Additionally, the rate at which the flames infiltrate into a wall or barrier, the speed at which heat is released, and the amount of smoke and toxic gas generated all have an effect on the fire resistance of the material [84]. However, it's important to understand the operation of fire-retardant chemicals, the differences between fire retardants, and to decide which one is better to use depending on the situation.

Most fire retardants for wood work by improving the pyrolysis of cellulose through the fire

combustion pathway that leads to char formation. Fire retardants stabilize the wood molecules against decomposition by slowing down pyrolysis reaction. It can create an isolating surface layer that reduces temperature rise, the release of pyrolysis gases, and the oxygen penetration on the surface. These factors can be achieved using intumescent fire retardant surface treatments which can expand when the temperature rises, as a result form a thick layer that works as a shield that will protect the wood surface from flames. The typical fire retardant coatings for wood are compounds that contain halogens, phosphorus, nitrogen, boron compounds [85].



**Figure 2. 3:**Schematic diagram represents wood combustion process [85].

## **2.7.2 Pre-treatment Fire retardants for wood**

### **2.7.2.1 Phosphorus compounds**

Many fire retardants could be used as pre-treatment of wood in CWC. Among chemicals, phosphorus compounds are well known as fire retardants for wood. The most popular phosphorus compounds as fire retardants are phosphoric acid and mono- and diammonium phosphate salts. In addition, phosphate salts of nitrogen containing organic compounds are also commonly used [86]. In general, the phosphorus fire retardants are divided into three categories: those containing inorganic, organic and halogen components. Those containing halogen component are the least environment friendly ones. Their mechanism works in most cases in the solid phases of burning material but it can be active in gas phase also [87]. The phosphorus compounds are efficient as fire retardants, because they reduce the thermal degradation of wood [88]. The phosphorus chemicals work as fire retardant by forming acids that decrease the temperature of the wood [89] and as a result increase its dehydration and char formation [90], [91]. Char works as a barrier for oxygen and volatile organic compounds (VOCs). Hence, low cost, environmentally friendly phosphorus compounds act as fire retardants in the materials containing a high amount of oxygen-like cellulosic [92], [93]. This has made phosphorus compounds the most investigated fire-retardant chemicals for wood over the years. That's the reason of choosing diammonium and disodium hydrogen phosphate as fire retardants in this research work.

### **2.7.2.2 Boron compounds**

The second most popular fire retardants are boron compounds. Boron, a well-known product used in various agricultural and industrial applications such as glass fibre production and material processing, is the second most popular fire retardant for wood [94]. Boron compounds are durable due to their deep wood penetration [92]. Boron compound-based fire retardants are the best fire retardants for cellulosic materials. Much research proving the effectiveness of boron compounds as fire retardants has been completed over the years. In most cases, two kinds of boron compounds are used: borax and boric acid. These two compounds act as effective fire retardants on wood surfaces and, due to their complementary characteristics, are generally used together. One advantage of borax is flame propagation suppression, but its major disadvantage is the promotion of smouldering. Conversely, boric acid is an effective smouldering suppressant, but its flame spread suppressing ability is low [95]. Borax is also used as a fire retardant with other chemicals such as potassium carbonate and Wolmanit. These three chemicals have been applied on oriented

strand board via brushing or dipping. The result of this comparison was that borax has the highest penetration capability and is one of the best choices for fire suppression in oriented strand board [96]. Boron compounds are present in different forms like pure compound or minerals and have many advantages when applied to solid wood and wood-based products. Boron compounds are easy to use and has various advantages like high thermal and biological resistance, low cost, low toxicity, eco-friendliness [97], [98]. Among boron compounds Borax was chosen to be used in this research.

### 2.7.2.3 Polyethylene glycol

Polyethylene glycol appeared as a fire retardant many years ago. Compared to the above-mentioned fire retardants, polyethylene is not a well-known fire retardant. A 1995 research study employed polyethylene glycol with phosphate as a fire retardant with positive results, but when the temperature reached 80 °C, the phosphate began to decompose and became less stable [99]. In recent study an experiment for improving the fire resistance of scots pine (*Pinus sylvestris*) by using Polyethylene glycol 400 and phosphoric acid as fire retardants was made. The investigation was made by using the single flame source test as fire test according to the standard (MSZ EN ISO 11925-2:2011). In addition, contact angle was measured to calculate the surface energy, surface polarity and wettability in order to give a better understanding to the used fire retardants and their effect on the surface of Scots pine. Results showed that Polyethylene glycol 400 and phosphoric acid are effective as fire retardants in case of a high dose of phosphoric acid and minor time in the microwave [100]. A 2016 study by Wang and Shi, focused on the influence of molecular weight of polyethylene glycol (PEG) on thermal and fire protection of pentaerythritol phosphate (PEPA). Four types of PEG were used with different molecular weights: PEG 150, PEG 200, PEG 400, and PEG 600. The results of the fire protection of fire-resistant coatings and the intumescence ratio test showed that PEG 600 had no efficiency on fire resistance, but PEGs with low molecular weights were more efficient as fire retardants for the intumescent coating. For the thermal degradation, the behaviour of fire resistant coatings results showed that char forming capability of intumescent coatings could be enhanced if PEG had low molecular weight [101]. PEG 400 is an inexpensive, eco-friendly fire retardant possessing thermal stability and hydrolyzation properties, all of which makes it an excellent fire retardant [102], [103].

### **2.7.3 Fire retardants treatment technology**

Fire retardant wood treatment technology is capable of converting combustible wood into flame resistant material. This kind of transformation is only possible by adding chemicals substances to wood. The best fire retardant should have many advantageous properties including high potency, eco-friendliness, and durability, and it should deliver these at low cost and low toxicity. The efficiency of flame-retardant treatments depends not only on performance and usage, but also on the distribution of these treatments in the wood itself. Therefore, the choice of a suitable application method is crucial [104].

The characteristics of any material depend upon the chemistry of the components within the material itself. For wood, the cell wall polymers such as cellulose, hemicelluloses, and lignin represent the modified components after fire retardation treatment. The chemical modification performed on these components alters the performance of wood. This idea is applied to solid wood and wood-based products as well. The approaches to cell wall modification are numerous and depend on the characteristics are modified. For example, to achieve the objective of flame retardancy, chemical groups can be bonded into cell wall polymers containing retardants or flame suppressants [105]. Petric [106], stated that surface modification by densification and/or resin impregnation can be considered a wood improvement. Surface modification serves the exact same purpose as bulk modification, but the treatments are restricted to only the first few surface layers of wood. Fire retardants can be applied on untreated wood by soaking, spraying or coating.

### **2.8 Selected CBPB Components and influencing factors on fire retardant performance**

For cement bonded particleboard production, not all wood species are suitable. Contrary to other materials wood is anisotropic, inhomogeneous and capillary diverse porous, and several studies emphasized that the measurable characteristics are wood species dependent [107]. Furthermore, within one species, the properties may differ according to the plantation characteristics and eventual clone variations of the same wood species [108]–[110]. Choosing the right wood species depends on the chemical structure of wood and on the type of wood cement composite produced, because the sugar and tannin content of the wood species is different [44]. It is important to choose the right wood species, the ratio of wood cement and ratio of cement water because the amount of extractives effects the cement hydration process [25]. In addition, the age, place of growth and season of harvesting are with influence also.

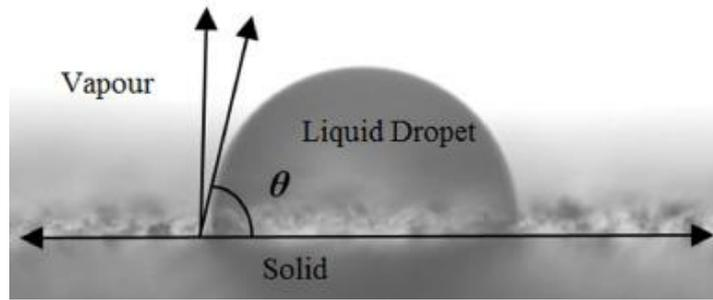
The Scots pine is usually used in production of cement bonded particleboards in industry line because contains few extractives [111]. Alpár and Rácz, [112] proved that the poplar hybrid I214 is suitable for cement bonded particleboard production and more economic than Scots pine. Yearly about 1.3 – 1.5 million m<sup>3</sup> poplar wood are extracted from the 1,5 million has populated by these species in Hungary. The industrial utilization of the extracted stock approximates 90 %, and there are huge plantations as the species develop a considerable wood trunk mass even on poor, humid soil. Nowadays, 23-25 % of the whole Hungarian timber extraction consists of poplar wood and according to Molnár and Bariska [113] Poplar I 214 (*Populus cv. euramericana I 214*) is the most prevalent poplar hybrid in Europe, and currently occupies the largest area in Hungary among the poplars. When large masses of wood material are reached, their maturity raises the question of a better utilization. This is the case of the Hungarian poplar plantations; the target is to improve their utilization, to check their suitability for construction material purposes. In this context, fire retardancy is a major aspect, which can be improved by using different type, amount and concentration fire retardants. Poplar wood in this context is rather under investigated as possible engineering material for CBPB production. Since cement wood composites are made of cement and wood, their resistance to fire is better than the one of pure wood, but still does not reach the level of concrete. In order to enhance the fire resistance of cement bonded particleboards (CBPB) by pre-treating the wood particles with FR the first goal is to find the suitable FR for poplar and Scots' pine. And to look for the answer whether the good wetting fire retardants are offering the best fire resistance? There is the hypothesis that if FRs spread nicely all over the material, they give a uniform, good covering of the surface. Many studies were made about testing wettability of FR treated wood surface but no research was found on testing wetting with the fire retardant itself.

When investigating the effect of aluminium trihydrate (ATH), zinc borate (ZB), graphite, melamine and TiO<sub>2</sub> as FR's, on mechanical properties and wettability of coextruded PP based WPC, concluded that the wettability of the fire retardant treated composites decreased with the amount of FR [114]. This would be equal with an increase of the contact angle with increasing amount (concentration) of the FR. Kong et al. reports [115] after treating poplar wood with furfuryl alcohol, for an improved dimensional stability and with ammonium dihydrogen phosphate for flame retardancy, that small amount of ammonium dihydrogen phosphate enhances the flame retardancy of the furfuryl alcohol treated wood. Ayrilmis, [116] investigated the effect of FR's on surface roughness and wettability of WPC panels, with the conclusion that the surface smoothness

of the WPC panels decreases with the amount of the FR powder, whilst the wettability increased. Ayrimilis et.al, [117] investigated the effect of various FR's on the surface roughness of plywood, with the conclusion that the surface quality of the panels decreased with increasing chemical concentration. Rábai, [118] investigated the wettability of sanded and planed surfaces of poplar wood originating from different plantations, and concluded that both the origin and the grain orientation (radial and tangential cut) have significant effect on the measure of the contact angle. Papp and Csiha, [119] reported exponential function between the contact angle (measured with DW) and the roughness of the surface, meaning that surface roughness influences the wettability of the wood surface. The above papers evaluate the effect of the FR on the roughness of the surface but offer no information about the opposite: the influence of wood surface roughness on the fire performance. This research work searched for an answer, that when machined in the same way and treated with the same FR is there a relevant influence of wood species, and furthermore is there a relevant influence of machining type on the wettability with FR's, specially focused on poplar hybrid I214 and Scots' pine. The surface quality of wood is machining type dependent which characterises by surface roughness [120]. The machined wood surface is not ideally smooth because of surface irregularities like protruding parts, valleys, and peaks, generally called roughness [121].

Wang et al. investigated the surface free energy and dynamic wettability of poplar wood veneer simultaneously treated with acidic dye and FR, by measuring the contact angle with formamide, diiodomethane, DW and phenol formaldehyde (PF) adhesive [122]. They concluded that the FR reacted chemically with wood, the surface free energy of the FR treated samples used to be higher than the untreated wood samples and the contact angle of PF adhesives on the FR treated wood surface decreased over time.

Wetting of solids with different liquids is always a good indicator of the measure of spreading and in case of film forming liquids of the measure of adhesion of those to the wood surface. Generally, wettability is evaluated based on the contact angle  $\theta$ , formed between a drop of liquid (*a demi sphere*) relaxed on an ideally smooth solid surface and the tangential drawn to the drop in the point of intersection. (Fig.2.4). A higher contact angle than  $90^\circ$  means low wettability, a contact angle smaller than  $90^\circ$  means high wettability and it can be expected that the liquid will spread well. For maximum wettability contact angle should be  $0^\circ$  [123]. According to this theory, contact angle is measured on a perfectly smooth surface.



**Figure 2. 4:** Contact angle ( $\theta$ ).

Wenzel [124] suggests that in case of rough surfaces the apparent contact angle  $\theta_w$  on a geometrically rough surface should be considered according to the following formula.

$$\cos\theta_w = r \cdot \cos\theta_Y \quad (1)$$

where  $\theta_w$  is the apparent contact angle,  $\theta_Y$  is the Young contact angle, and  $r$  is a roughness factor, which is the ratio of the rough surface to the area of the effective planar surface  $A_r/A$ . Young [125] declared that for a homogenous and ideally smooth surface the contact angle for a wetting droplet is written by the following equation:

$$\cos\theta = \frac{\gamma_{sv} - \gamma_{sl}}{\gamma_{lv}} \quad (2)$$

Where  $\gamma_{sv}$  is the surface tension at the solid-vapour interface,  $\gamma_{sl}$  is the surface tension at solid- liquid interface and  $\gamma_{lv}$  is the surface tension at liquid-vapour interface. We did our evaluation based on apparent contact angle values, since the measuring liquid used to be the FR itself, thus the spreading of the FR monitored directly on the real surface. Instead of went forward to calculate the surface tension of the differently rough surfaces, it was better to consider that the primary data is the value of the apparent contact angle, which offers a good basis for comparison even without the calculation of the surface tension values, which would be anyhow proportionate to the contact angle values. Regarding machining several authors published that in case of wood the smoothest surface is provided by sanding [126]–[128] . There are some studies dealing with the wettability of poplar and Scots pine, but not in the context of fire resistance. In order to make our results comparable in some aspect, surfaces were tested with DW too. Oberhofnerova and Panik [129] monitored the changes of the contact angle during weathering, but they report on initial data on poplar and Scots pine as well. On sanded surfaces (grain size 120) they measured with DW on poplar, contact angle  $51^\circ$  and on Scots pine  $82^\circ$ , using a  $10 \mu\text{l}$  drop. Wettability of

planed and sawn poplar surfaces, measured beside other liquids with DW also, drop of 3  $\mu$ l, and roughness characterized by  $R_a$  [130]. They found mostly similar contact angle values: 46.34 – 48.07 on sapwood and heartwood for both sawn and planed surfaces. DW drop of 4  $\mu$ l, used for measuring the contact angle of Scots pine, being 46 on surfaces sanded/polished with sandpaper of grain size 320 [131].

Based on literature, Scot's pine as soft wood and poplar as hardwood were chosen as wood species. Since CBPB is material used in general construction, and doesn't be used as main element for structure it doesn't need high strength, CEM I 42.4 N was used especially it's the same cement that Falco Zrt. uses in its production line of CBPB. As fire retardant, diammonium and disodium hydrogen phosphate, sodium tetraborate and polyethylene glycol were selected. Sodium silicate and mixture of PDDA+MM were chosen as agent binder because both works perfectly as cement wood binders and both have fire retardation property. According to literature, fire retardants performance may be affected by many factors like concentration, wood surface roughness and wettability. As well no literature was found on effect of fire retardants on cement curing which led to divide the research work to two parts. First making primary tests were all the above-mentioned factors will be tested and evaluated based on it fire retardants will be used in CBPB which is the second part of the research work.

## CHAPTER III

### 3 Materials and Methods

Enhancing the fire resistance of CBPB with fire retardants is a new research topic. No information was available neither on the effectiveness of the selected fire retardants on the used wood species nor on their effect on cement curing. Before starting the CBPBs production with fire retardants treated particles, it is better to conduct some tests to collect some pieces of information. Results can help to draw a plan of which and how fire retardants will be introduced to CBPBs production.

#### 3.1 Part I: Primarily test

In this part, primarily tests were conducted to collect some information on the chosen fire retardants and their effect on fire resistance of wood and cement curing.

##### 3.1.1 Description of the used material

This study examined two tree species: Scot spine (*Pinus sylvestris*) and poplar hybrid I214 (*Populus cv. euramericana I214*). Scot's pine was provided by the (Falco Zrt.) wood industry company in Szombathely, Hungary, and the poplar originated from the Derula Ltd. plywood company in Magyarszecsőd, Szombathely, Hungary. A boron compound borax ( $\text{Na}_2\text{B}_4\text{O}_7$ ) with a concentration of 25 g/l, and phosphorus compounds DSHP ( $\text{Na}_2\text{HPO}_4$ ) with 25 g/l and 77 g/l concentrations, DAHP ( $(\text{NH}_2)_4\text{HPO}_4$ ) with 25 g/l and 300 g/l concentrations, and PEG 400 were employed as fire retardants (Table 3.1). The fire retardants utilized were in powder form except for PEG 400, which was in liquid form. The powder-form retardants were dissolved in distilled water to become liquids under solubility temperature of 20°C.

**Table 3. 1:** concentration of the fire retardants in scope.

	Borax	DSHP	DAHP
Concentration	25 g/l	25 g/l	25 g/l
	–	77 g/l	300 g/l

For hydration test, Portland cement CEM I 42.5 N, and Sodium Silicate ( $\text{Na}_2\text{SiO}_3$ ) with density of 1.09 g/m<sup>3</sup> were used (Falco Zrt. wood industry company, Szombathely, Hungary).

For contact angle measurement, the fire retardants have been used as a test liquid of contact angle measurement in addition to DW as the 6th test liquid to offer the basis of comparison with possible external results. There are no literature data available for poplar or Scot's pine measured with these fire retardants as test liquids. However, many data exist with distilled water, DW used as a reference test liquid.

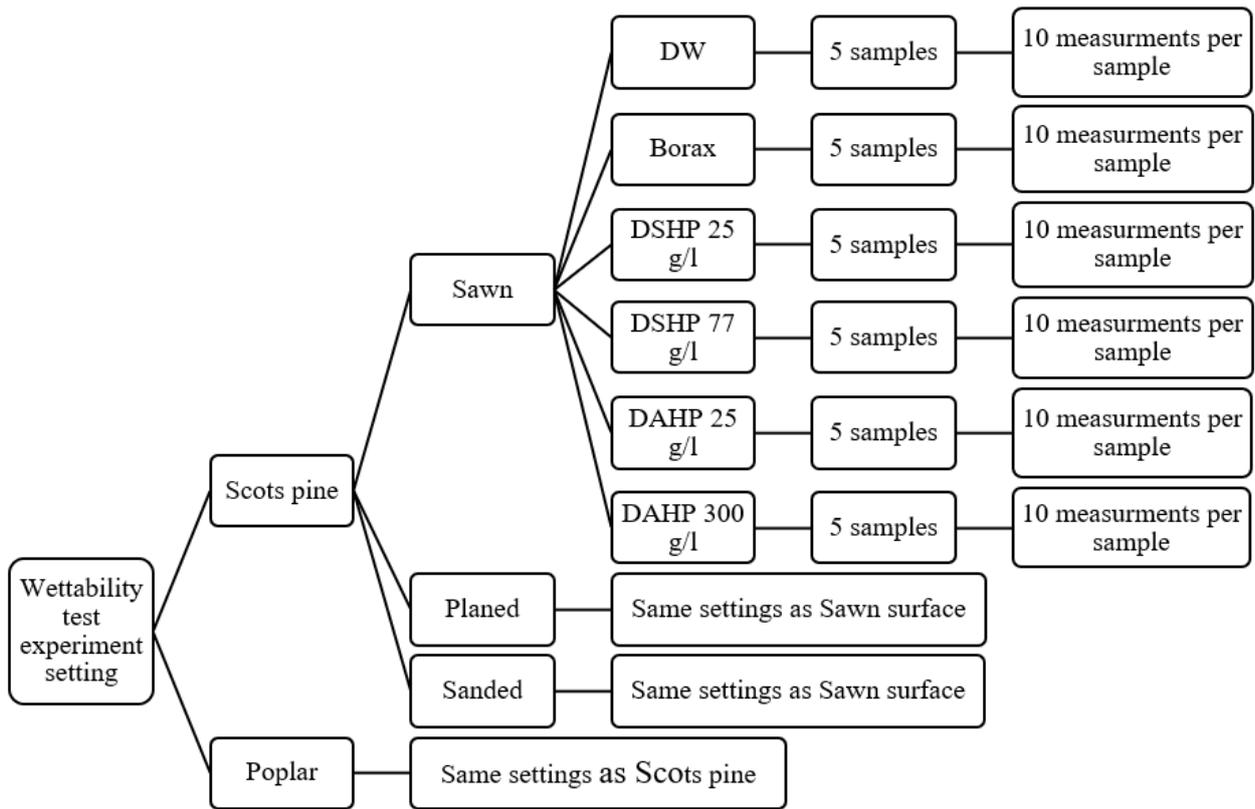
### **3.1.2 Description of used experimental methods**

#### **3.1.2.1 Surface Roughness test**

Since the wood used in CBPB production is particles, the surface quality is not perfectly smooth. In case of wood, sanded surface is the best-processed wood quality [132]. Boards from Scots pine and poplar with three types of surfaces – sawn with a band saw, planed with a planer, and sanded with a belt sander (sand paper grit size 120) – were prepared by dimension (250x90x10) mm. The measurements have been conducted on poplar hybrid I214 (*Populus cv. euramericana I 214*) and Scots Pine (*Pinus sylvestris*) samples. In order to describe the status of the surfaces, wood surface roughness was also measured, using a stylus tip MAHR S2P perthometer instrument, with a tip diameter of 2  $\mu\text{m}$ . Fifteen measurements on each differently machined wood species have been performed, with a difference of 50  $\mu\text{m}$  between the consecutive measurements, on three samples resulting five measurements on each sample. The unfiltered primary profile has been evaluated by  $R_a$ , the mean roughness [133],  $R_z$  the mean roughness depth and  $R_{\text{max}}$  the maximum roughness, according to the standard DIN EN ISO 4288 [134].

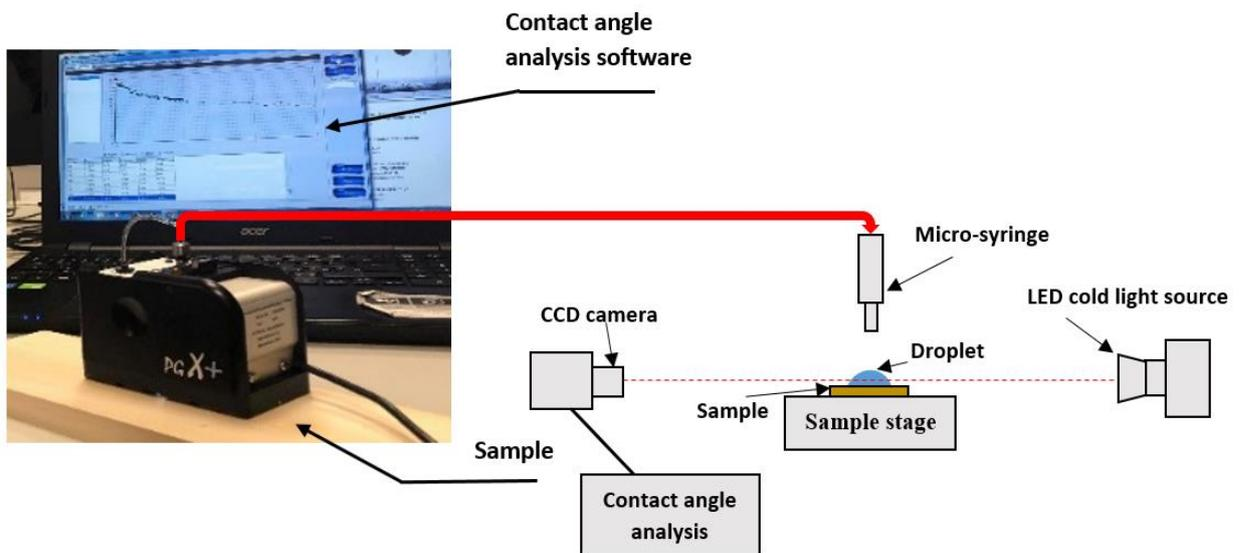
#### **3.1.2.2 Wettability test**

Sanded, sawn and planed radial cut surfaces have been prepared with dimension of (250x90x10) mm from poplar and Scots pine, tested with 6 different test liquids. 5 samples being grouped for each type of combination, and 10 measurements have been performed on each sample. Resulting 50 measurements on each type of sample group and 1800 contact angle measurements in total (Fig.3.1). Prior to testing, all samples have been conditioned at room temperature of 20° C and RH of 65 % until reaching constant weight. The average MC of the samples was 6.1 %. In order to test wettability of the two wood species, machined in three different ways, PG-X Goniometer was used (Fig.3.2). The size of the testing droplet can be adjusted prior to measurements. The effect of droplet's size on contact angle was always a question and it appears that when surface is rougher may cause significant effect [135], [136].



**Figure 3. 1:** Wettability test experimental setting.

As we could not find any literature data on tests performed with the fire retardants in scope as test liquids, small tests were conducted to decide which size of the droplet would be appropriate. Finally, a droplet of 5  $\mu\text{l}$  has been chosen, the tests have been performed in dynamic mode, and the apparent contact angle was taken in the 0.5<sup>th</sup> second [137].



**Figure 3. 2:** Schematic description of contact angle measurement by PGx goniometer.

### 3.1.2.3 Lindner test

To perform the Lindner test, six test species for each surface type and wood species were used with each of the fire retardants. In total, 126 specimens for each type of wood were tested, and 18 specimens were left untreated as control (see Fig.3.3). Specimens were kept at a room temperature of 20 °C with a relative humidity of 65 % for 24 hours. Subsequently, the surface of each of the species was treated by spreading 5 g of each fire retardant with a brush. Specimens were allowed to dry for 24 hours in an ambient room condition. The room conditions (RH = 52 %, T = 22 °C) were similar to the conditions initially used for the 24-hour period (RH = 65 %, T = 20 °C), only this time the specimens were left for seven days according to standard MSZ 9607/1-83 (Hungarian National Standard) [138]. In general, this test is igniting wood samples via stove fire, but rather than using gas, a 1g pill of hexamethylenetetramine was ignited instead, and the wood specimen was placed on an iron stand above the flame. The burning time was the total burning time of examethylenetetramine pill. Mass loss was calculating based on following equation:

$$M = M_0 - M_1 \quad (3.1)$$

Where, M: Mass loss (g), M<sub>0</sub>: initial mass (g), M<sub>1</sub>: Mass after burning (g).

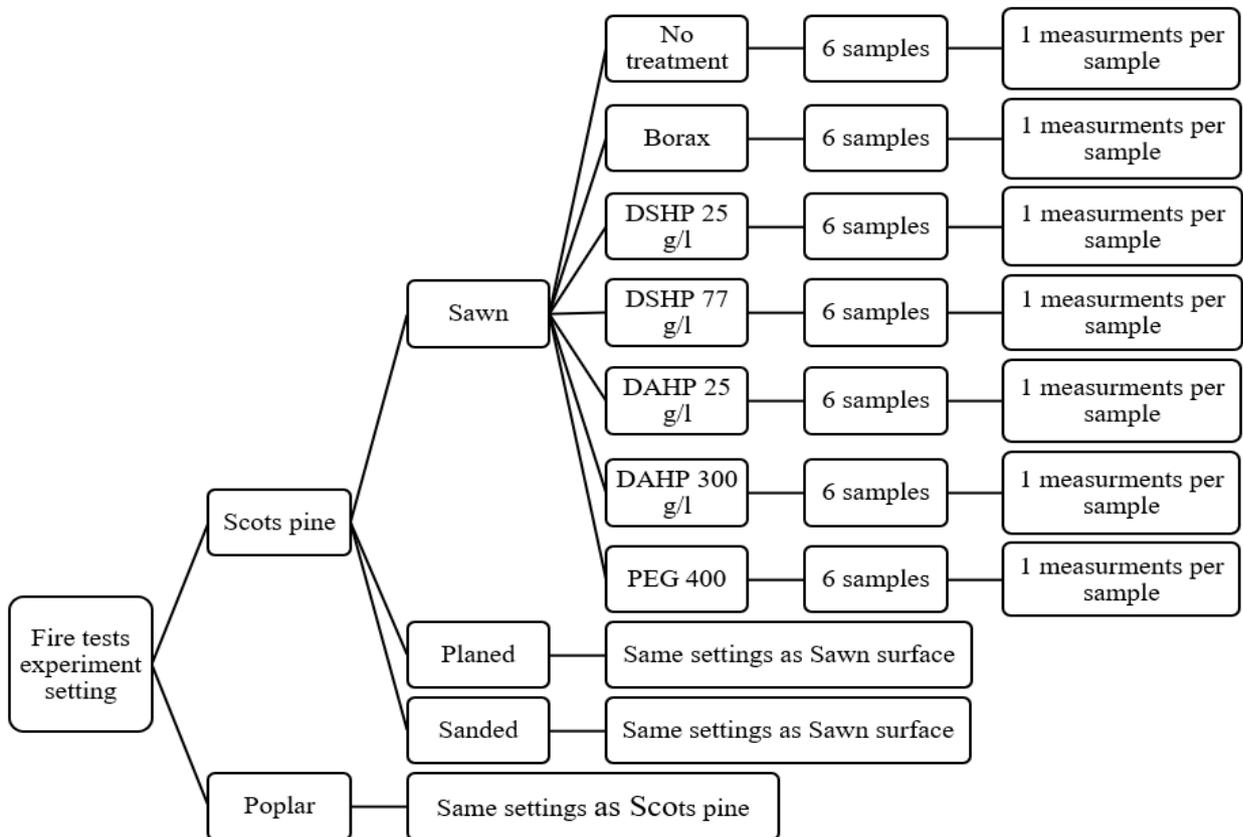
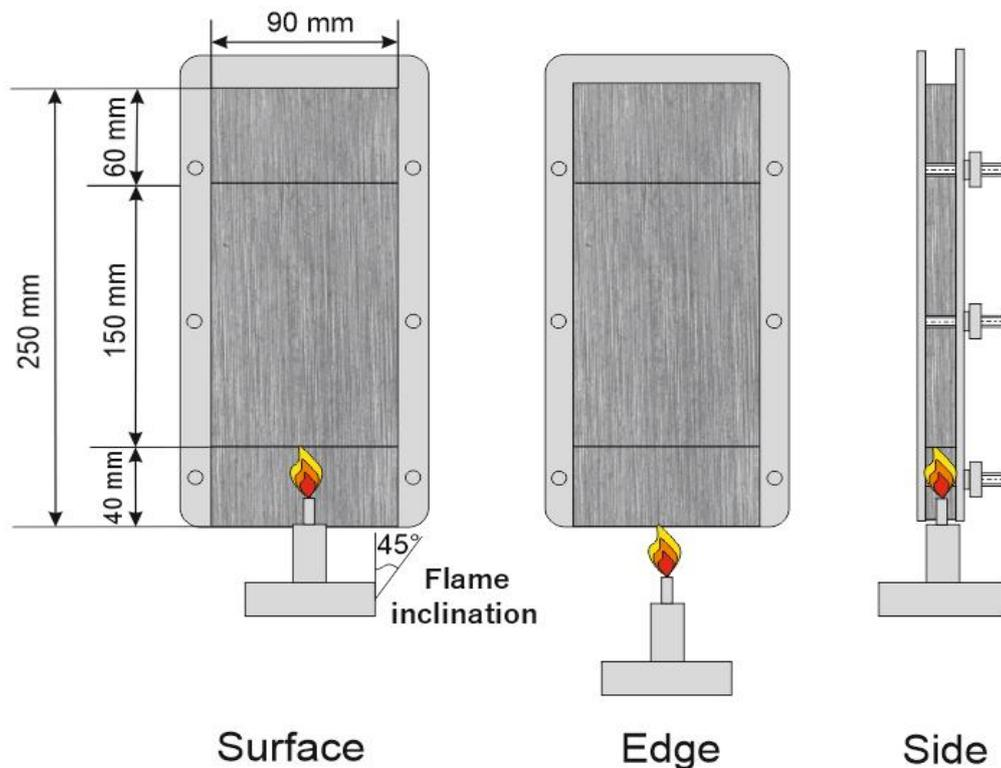


Figure 3. 3: Fire tests experimental setting.

### 3.1.2.4 The single flame source test

The surface treatment and preparation for the Lindner test and the single flame source test were achieved in the same manner (see Fig.3.3). However, in case of the single flame source test, specimens with dimension of (250x90x10) mm were used. The single flame source test was accomplished according to standard MSZ EN ISO 11925-2:2011 *Reaction to fire tests. Ignitability of products subjected to direct impingement of flame. Part 2: Single-flame source test* with Taurus Instruments [16]. The aim of this test was to measure the ignitability of a vertically-oriented test samples exposed to a small flame. The specimens can be exposed at three different spots, either at the surface, the side or at the edge (Fig.3.4). In our test, the face was used. The specimens for this test were prepared by marking two lines on the surface of each specimen. The first line was 40 mm above the bottom of the specimens and the second line was located 150 mm above that. This space marks the flame area according to the standard. The first line is where the flame should be started. If the flame exceeds the second line, the specimen is out of standard. The test duration is 30 s. During the first 15 s, the specimen is burned. In the second 15 s period, observations concerning the success or failure of ignition are noted.

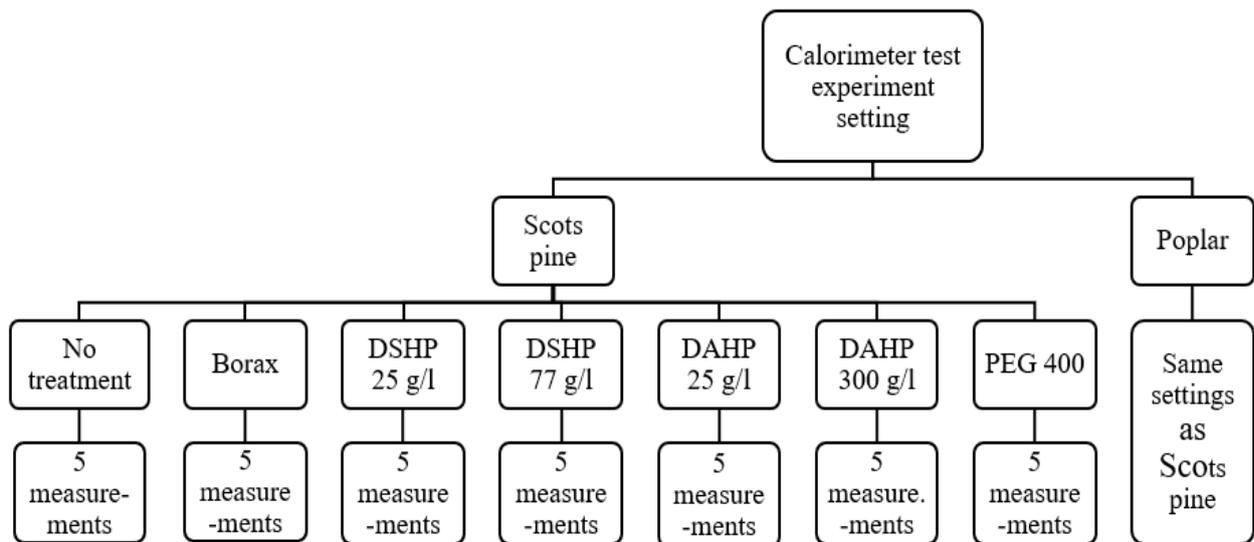


**Figure 3. 4:** The single flame source test.

### 3.1.2.5 The bomb calorimeter test

The bomb calorimeter is a heat of combustion measuring device of materials. Specimen with mass range between 0.6-1.2 g is burned inside the apparatus under standardised conditions [139]. The heat of combustion is calculated based on the observed temperature rise while the heat loss was taken into consideration.

In preparation for the calorimeter test MSZ EN ISO 1716:2011, the poplar and Scot's pine hammer-milled particle were then kept in a room climate with a relative humidity of 65% and a temperature of 20 °C for 24 h. Afterward, 8 g of the particles were soaked into each fire retardant for 1 min, before being drained and left to dry. The tests were performed with a Parr™ 6200 Compensated Calorimeter. For the test, a bucket was filled with 2000 g of water and 1g of particles was put inside a calorimeter bomb, which was filled with oxygen. After that, the calorimeter bomb was put in the water bucket. The total test time was around 15 min.



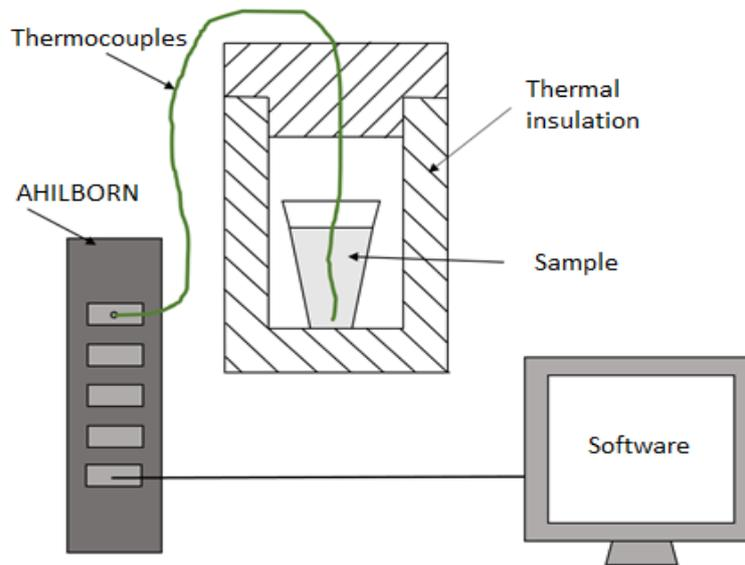
**Figure 3. 5:** Calorimeter test experimental setting.

### 3.1.2.6 Hydration test

For hydration test, mixture of Portland cement CEM I 42.5 N, Sodium Silicate ( $\text{Na}_2\text{SiO}_2$ ) water glass (SS), mixing water and fire retardant was created. The amount of the added FR's was calculated based on the wood and dry after 24 hours. The mixture was poured into small cups and thermocouples were inserted into the mixture to measure the temperature change during cement curing for 24 hours. The thermocouples were connected to an AHLBORN device that was linked to a laptop via special software that collected the temperature data directly into an excel sheet with a given sampling rate (Fig.3.6).

**Table 3. 2:** Hydration test experimental setting.

Variant	Cement	Additive	Fire retardants	Samples
1	CEM I 42.5 N	Sodium Silicate	No treatment	3 samples
2	CEM I 42.5 N	Sodium Silicate	Borax	3 samples
3	CEM I 42.5 N	Sodium Silicate	DSHP 25 g/l	3 samples
4	CEM I 42.5 N	Sodium Silicate	DSHP 77 g/l	3 samples
5	CEM I 42.5 N	Sodium Silicate	DAHP 25 g/l	3 samples
6	CEM I 42.5 N	Sodium Silicate	DAHP 300 g/l	3 samples
7	CEM I 42.5 N	Sodium Silicate	PEG 400	3 samples

**Figure 3. 6:** Schematic description for hydration test.

### 3.2 Part II: CBPB tests

#### 3.2.1 Raw materials and chemicals

Derula Ltd. plywood company, (Magyarszecsőd, Szombathely, Hungary), supplied poplar (*Populus cv. euroamericana I214*) logs. Particles of Scots pine (*Pinus sylvestris*), Portland cement CEM I 42.5 N, and Sodium Silicate ( $\text{Na}_2\text{SiO}_3$ ) were obtained from Falco Zrt. wood industry company, (Szombathely, Hungary). Chemicals: Borax ( $\text{Na}_2\text{B}_4\text{O}_7$ ), DSHP ( $\text{Na}_2\text{HPO}_4$ ), DAHP ( $(\text{NH}_2)_4\text{HPO}_4$ ), montmorillonite (MM)  $(\text{Na,Ca})_{0.33}(\text{Al,Mg})_2(\text{Si}_4\text{O}_{10})(\text{OH})_2.n\text{H}_2\text{O}$ , Polydiallyldimethylammonium chloride (PDDA)  $(\text{C}_8\text{H}_{16}\text{NCl})_n$ , Lead Acetate Trihydrate (LAT)  $(\text{C}_4\text{H}_6\text{O}_4\text{Pb}_3\text{H}_2\text{O})$ , Sulfuric acid (SA)  $(\text{H}_2\text{SO}_4)$ , Sodium hydroxide (SH)  $(\text{NaOH})$ , Copper(II)

sulfate pentahydrate (CSP) ( $\text{CuSO}_4 \cdot 5\text{H}_2\text{O}$ ) and potassium sodium tartrate tetrahydrate (PSTT) ( $\text{C}_4\text{H}_4\text{O}_6\text{KNa}$ ) were purchased from Thomasker Ltd (Budapest, Hungary).

### **3.2.2 Experimental settings:**

#### **3.2.2.1 Fire retardant preparation**

The fire retardants used were in powder form. They were dissolved in distilled water to become liquids. Chemicals were prepared with concentration of 150 g/l for DAHP, 77 g/l for DSHP and 25 g/l for Borax under solubility temperature of 20 °C.

#### **3.2.2.2 Wood particle preparation**

In the Falco company production line of CBPB only scots pine was used. Particles of Scots pine were obtained prepared for the CBPB production. However, for poplar hybrid I214 (*Populus cv. euramericana I214*) only wood logs were obtained from a plywood company and particles were prepared by cutting the logs into tall sticks after that crashed into small chips and finally hammer-milled with using a sieve (hole diameter 5 mm) for controlling the particle size. Particles of poplar were separated into two part from 0.314 to 2 mm for surface layer and from 2 to 5 mm for core layer.

#### **3.2.2.3 Wood particle extractives and size distribution**

Fritsch Analysette particle analyzer was used to measure the quantitative wood particles size distribution of poplar and Scots' pine. 100 g of wood particle were passed through 7 sieves with diameter of 0.314, 0.5, 1, 2, 3, 4, 5 mm (Fig.4.1). Measurement was repeated 5 times.

Suitability of wood species for CBPB production depends on the number of extractives in the wood. Sugar and tannin content measurement was done in order to confirm that the wood particles are suitable. For measuring the tannin content, 10 g of wood particles used for the test are kept in 200 ml of hot distilled water in an Erlenmeyer flask, put above stove, and let boil for 30 min at temperature between 90-100 °C. The resulting liquid is filtered with filter paper and adjusted to exactly 200 ml with hot DW. 20 cm<sup>3</sup> of the aqueous extract was put into test tubes with diameter Ø 16 mm and add to each tube 0.7 g of (LAT) let to rest for 24 hours after that measure the height of the resulting foam and compare it to diagram.

For Sugar, content measurement, pipette 100 ml of the aqueous extract into a 250 ml Erlenmeyer flask. 1 g of (LAT) is added. In the reaction, the existing tannin completely dissolves and precipitates. (This is necessary for larger amounts of tannin because it is cleaved by hydrolysis with sulfuric acid and gallic acid in d-glucose and therefore has a sugar content in the Fehling's solution reduction.) The dissolved tannin is filtered off and washed twice with distilled water in a 250 ml Erlenmeyer flask and 5 ml of (SA) added, the resulting white lead sulphate precipitate was again filtered off quantitatively. The resulting filtrate was heated at 90-100 ° C for 30 minutes (wood sugars were reduced to monosaccharides). After cooling, carefully pH adjusted to 8-9 with (SH). The pH must be adjusted carefully with (SH) particles to not exceed 100 ml. Pour into a 100 ml standard flask and make up to the mark. Take 20 ml of the obtained solution, put into beaker, and add 1 ml of Fehling's solution. The mixture is then boiled for 2 minutes. If the solution turns blue or bluish green, it contains copper sulfate. The wood in this case contains less than 0.5 % sugar amount. Conversely, if the solution becomes colourless, a further experiment must be carried out with 20 ml of aqueous extract and 2 ml of Fehling's solution. The Fehling's solution is made of solution A: (CSP) with concentration of 6.39 g/l and solution B: mixture of 34.6 g of (PSTT), 10 g of (SH) and 100 ml of DW.

#### 3.2.2.4 CBPB production, mat formation and processing

Particles of Scots pine and poplar were treated with fire retardants by spray gun in a drum blender. The initial moisture content of wood particle was around 18 %. 1 L of FR were sprayed for 3 kg of wood.

**Table 3. 3:** CBPB recipe production.

Recipe	R1	R2	R3	R4
Wood	1	1	1	1
Cem	2.6	2.6	2.6	2.6
SS	0.052 (2 %)	0.13 (5 %)	0	0
PDDA	0	0	0.002 (0.2 %)	0.2 (20 %)
MM	0	0	0.002 (0.2 %)	0.2 (20 %)
CS	0.52	0.52	0.52	0.52
Total	4.172	4.25	4.122	4.32

**Note:** The recipes were given in ratio because of difference in MC of wood particles from board to another.

CBPB were produced from treated Scots pine and poplar particles. The boards have three layers, the core layer with big particles and two surface layers with small particles. Sodium silicate was used as additive to increase the cement wood compatibility first with 2 %, then 5 % of the cement weight. A mixture of PDDA and MM were used as well with different amount 0.2 % and 20 % of the cement weight. The used additives well known as bender for Scot's pine and poplar with cement and as well good fire retardants. The recipes (R) shown in, (Table 3.3) manufactured all 32 CBPB's with one replication for each (Table 3.4).

**Table 3. 4:** Produced CBPBs and experimental matrix (NB: number of replication).

Board ID	Wood particles	Treatments	Additives	Additives amount	Recipe	NB
Sc-N-SS-2	Scots pine	No treatment	SS	2 %	R1	2
Sc-N-SS-5	Scots pine	No treatment	SS	5 %	R2	2
Sc-N-PM-0.2	Scots pine	No treatment	PDDA+MM	0.2 %	R3	2
Sc-N-PM-20	Scots pine	No treatment	PDDA+MM	20 %	R4	2
Sc-B-SS-2	Scots pine	Borax	SS	2 %	R1	2
Sc-B-SS-5	Scots pine	Borax	SS	5 %	R2	2
Sc-B-PM-0.2	Scots pine	Borax	PDDA+MM	0.2 %	R3	2
Sc-B-PM-20	Scots pine	Borax	PDDA+MM	20 %	R4	2
Sc-DS-SS-2	Scots pine	DSHP 77 g/l	SS	2 %	R1	2
Sc-DS-SS-5	Scots pine	DSHP 77 g/l	SS	5 %	R2	2
Sc-DS-PM-0.2	Scots pine	DSHP 77 g/l	PDDA+MM	0.2 %	R3	2
Sc-DS-PM-20	Scots pine	DSHP 77 g/l	PDDA+MM	20 %	R4	2
Sc-DA-SS-2	Scots pine	DAHP 150 g/l	SS	2 %	R1	2
Sc-DA-SS-5	Scots pine	DAHP 150 g/l	SS	5 %	R2	2
Sc-DA-PM-0.2	Scots pine	DAHP 150 g/l	PDDA+MM	0.2 %	R3	2
Sc-DA-PM-20	Scots pine	DAHP 150 g/l	PDDA+MM	20 %	R4	2
P-N-SS-2	Poplar	No treatment	SS	2 %	R1	2
P-N-SS-5	Poplar	No treatment	SS	5 %	R2	2
P-N-PM-0.2	Poplar	No treatment	PDDA+MM	0.2 %	R3	2
P-N-PM-20	Poplar	No treatment	PDDA+MM	20 %	R4	2
P-B-SS-2	Poplar	Borax	SS	2 %	R1	2
P-B-SS-5	Poplar	Borax	SS	5 %	R2	2
P-B-PM-0.2	Poplar	Borax	PDDA+MM	0.2 %	R3	2
P-B-PM-20	Poplar	Borax	PDDA+MM	20 %	R4	2
P-DS-SS-2	Poplar	DSHP 77 g/l	SS	2 %	R1	2
P-DS-SS-5	Poplar	DSHP 77 g/l	SS	5 %	R2	2
P-DS-PM-0.2	Poplar	DSHP 77 g/l	PDDA+MM	0.2 %	R3	2
P-DS-PM-20	Poplar	DSHP 77 g/l	PDDA+MM	20 %	R4	2
P-DA-SS-2	Poplar	DAHP 150 g/l	SS	2 %	R1	2
P-DA-SS-5	Poplar	DAHP 150 g/l	SS	5 %	R2	2
P-DA-PM-0.2	Poplar	DAHP 150 g/l	PDDA+MM	0.2 %	R3	2
P-DA-PM-20	Poplar	DAHP 150 g/l	PDDA+MM	20 %	R4	2



**Note:** Sc-B-PM-20 board was not tested because it did not cure.

### 3.2.2.5 Mechanical properties

The qualification of the finished product requires the performance of tests specified in several standards. Standards not only define and standardize test methods but also define exact requirements for different products.

In general, many standards define the qualified products for both the domestic market and for export. In the case of CBPBs, based on MSZ EN 634-2:2007- Cement-bonded particleboards - Specifications - Part 2: Requirements for Ordinary Portland Cement (OPC) bonded particleboards for use in dry, humid and exterior conditions [140] the following standard test and requirements are adopted (Table 3.6).

- Testing of flexural strength and flexural elasticity factor: MSZ EN 310
- Tensile strength test perpendicular to the leaf plane: MSZ EN 319
- Determination of thickness swelling after soaking: MSZ EN 317

**Table 3. 6:** Requirements for specified properties according to MSZ EN 634-2:2007 [142].

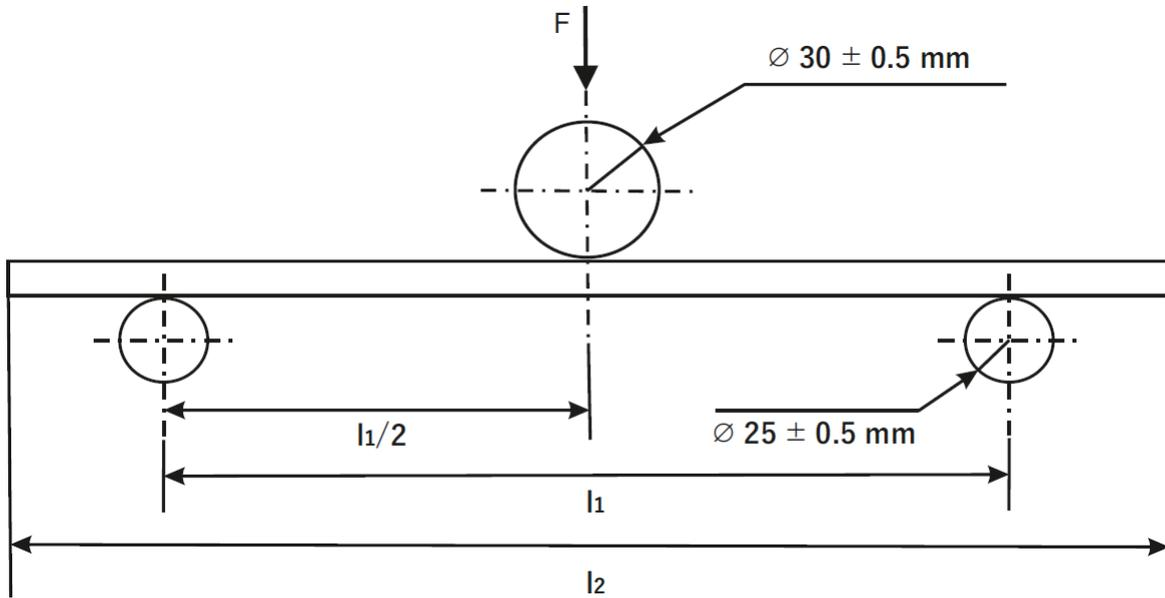
Property	Test method	Unit	Requirement
Bending test	EN 310	N/mm <sup>2</sup> (Mpa)	9
Internal bond	EN 319	N/mm <sup>2</sup> (Mpa)	0.5
Swelling thickness	EN 317	%	1.5

After 15 days, all produced CBPB's were cut for tests except (Sc-B-PM-20) it did not cure and was impossible to hold. Modulus of elasticity in bending and bending strength (Bending test) EN 310, internal bond (IB) EN 319 and Swelling in thickness after immersion in water (ST) EN 317 were made.

#### 3.2.2.5.1 Bending test

The flexural strength and the flexural elasticity factor have resulted from the central loading of two supporting specimens (Fig.3.7). Test specimens with dimension (250x50x12) mm were subjected to a load slowly to the point of failure with speed of 5 mm/min by Instron test machine with static mode. The speed was taken carefully during test, as too rapid sled movement may give an erroneous, non-static bending strength result. The failure load and displacement, was recorded for each specimen, and modulus of rupture (MOR) and density was calculated with

Blue hill software attached to the test machine INSTRON IN5566 [13]. In total 6 measurements were made for each type of specimen from the same board.



**Figure 3. 7:** Schematic diagram explains the bending test [140].

$l_1 = 200 \text{ mm}$ .

$l_1/2 = 100 \text{ mm}$ .

$l_2 = 250 \text{ mm}$ .

The bending strength was calculated based on the ratio of the bending moment ( $M$ ) for the breaking load  $F_{\max}$  to the cross-sectional factor with the following equation:

$$fm = \frac{3 * F_{\max} * l_1}{2 * b * t^2}$$

### 3.2.2.5.2 Internal bond test (IBS)

Test specimen with dimension (50x50x12) mm were glued into two plywood test surfaces with dimension of (70x50x10) mm under high pressure. A force perpendicular to the face were applied by INSTRON IN5566 test machine on test specimens gradually and continuously with speed of 0.8 mm/min under static mode until reach failure and tensile strength were recorded (Fig.3.8). In total 6 measurements were made for each type of specimen from the same board [14].

The formula used for calculation:

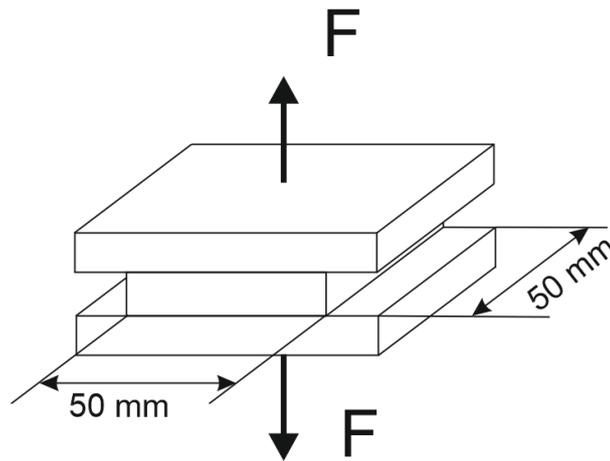
$$f_{ti} = \frac{F_{max}}{a * b}$$

Were,

$f_{ti}$  : Tensile strength perpendicular to the sheet plane (N /mm<sup>2</sup>).

$F_{max}$ : tensile force (N).

a,b : Width and length of the sample (mm)



**Figure 3. 8:** Schematic diagram explains the internal bond test.

### 3.2.2.5.3 Thickness swelling test (TS)

Thickness swelling [15] was calculated as the percentage difference in length over the initial thickness (Eq.3). Test specimens with dimension (50x50x12) mm were immersed in water for 24 hours at room temperature 17 °C. Thickness were measured at the middle of the specimen with digital thickness gauge. In total, 6 measurements were made for each type of specimen from the same board.

$$TS = \frac{T_2 - T_1}{T_1} \times 100 \% \quad (3)$$

### 3.2.2.6 Fire performance

#### 3.2.2.6.1 The single flame source test

The single flame source test was made according to standard EN ISO 11925-2:2011 *Reaction to fire tests. Ignitability of products subjected to direct impingement of flame. Part 2: Single-flame source test* with Taurus Instruments [16]. Test specimens with dimension (250x90x12) mm were

prepared from each CBPB. Each 3 specimens were subjected to edge, surface and side surface exposure from gas flame. During the test, ignition time, burning length was registered.

### 3.2.2.6.2 The non-combustibility test

Wazau test apparatus corresponds to standard MSZ EN ISO 1182:2010 [17] were used to determine the classification of the CBPB specimens. MSZ EN ISO 1182 Non-combustibility test is one of the Euro class test standards. The Non-combustibility test is made to determine whether the material will participate directly to fire expansion and is relevant to classification of all building products into classes A1 and A2 (Table 3.7) [141]. Test specimens were prepared with 45 mm diameter and approximately 50 mm height (Fig.3.9) five pieces were prepared from each specimen type. The specimen is inserted into furnace at 750 °C, temperature rise in the furnace specimen is measured and  $\Delta T$  was calculated, the flaming time and the mass loss are also measured. In order to increase the fire performance some test specimens were soaked into SS.



**Figure 3. 9:** Wazau non- combustibility apparatus and specimen .

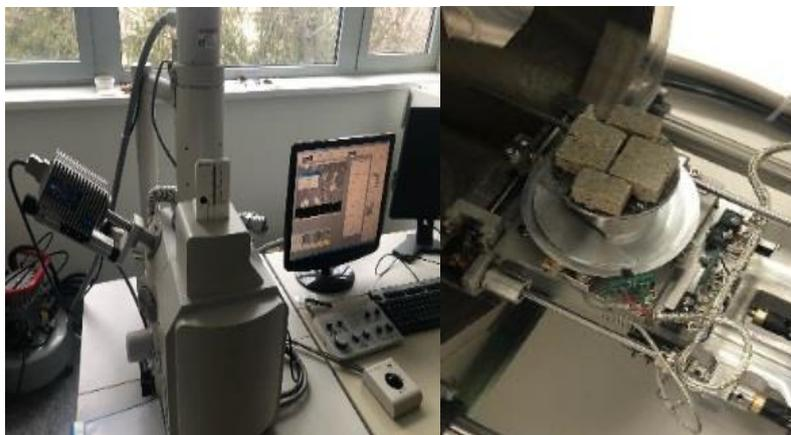
**Table 3. 7:** Classes of reaction to fire performance for construction product EN ISO 13501-1:2007 +A1:2010.

Class	classification criteria
A1	$\Delta T \leq 30 \text{ }^\circ\text{C}$ ; and $\Delta m \leq 50 \%$ ; and $t_f =$ (i.e. no sustained flaming)
A2	$\Delta T \leq 50 \text{ }^\circ\text{C}$ ; and $\Delta m \leq 50 \%$ ; and $t_f \leq 20 \text{ s}$

### 3.2.2.7 Characterization methods used for testing specimens

#### 3.2.2.7.1 Scanning electron microscopy (SEM)

SEM observation specimens were prepared with dimensions (10x20x10) mm for low magnification observation x500 and (10x4x4) mm specimens coated with platinum for high magnification x5 k. The observation was performed by electron mode at a beam current 60  $\mu$ A, accelerating voltage 20000 V and  $v_{acc}$ = 20 kv with Hitachi S-3400N instrument (Fig.3.10). SEM images were taken to compare the cement wood bonding for each specimen and to identify the cement mixture components at high magnification.



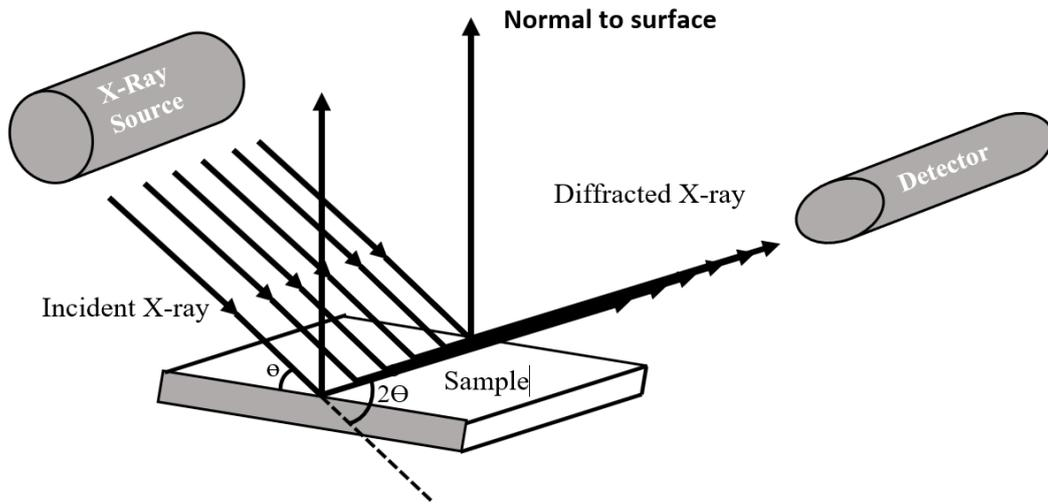
**Figure 3. 10:** Hitachi S-3400N scanning electron microscopy and specimens.

#### 3.2.2.7.2 Thermal gravimetric Analysis (TGA)

The thermogravimetric analyses were performed using LABSYS evo 1150 TGDSC. 140 mesh-powdered samples were examined but before measurement it was kept into room climate under  $T = 20\text{ }^{\circ}\text{C}$  and  $\text{RH} = 65\%$  till reach equilibrium of MC. Measurement were made under argon atmosphere with temperature range from room temperature to  $950\text{ }^{\circ}\text{C}$ , at flow rate 50 ml/min with heating rate of  $10\text{ }^{\circ}\text{C}/\text{min}$ . The mass loss curves were plotted against temperature.

#### 3.2.2.7.3 X-ray diffraction (XRD)

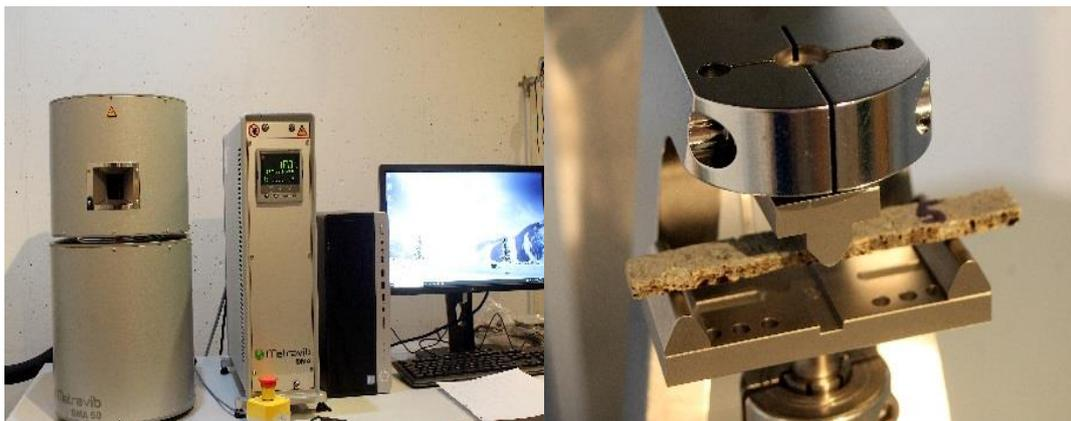
Powdred specimens of 140 mesh-pass taken from cured board of 28 days were examined by X'Pert Pro XRD (Fig.3.11). Step scan was measured using XRD at 40 kv and 40 mA,  $2\theta$  ranged from  $0^{\circ}$  to  $80^{\circ}$ . XRD was made in order to identify the cement component for each specimen and to observe if there are any new crystalline phases appeared because of the fire retardants presence.



**Figure 3. 11:** Schematic diagram Explain how XRD works with X’Pert Pro XRD.

#### 3.2.2.7.4 Dynamic mechanical analysis (DMA)

DMA test was carried out using a METRAVIB DMA 50 machine, test specimens with dimension of approximately (70x10x3) mm were used (Fig.3.12). Three points bending mode was chosen with frequency of 1 Hz, and heating range from 20 to 200 °C at heating rate of 3 °C/min, 100 point was taken during measurement and Storage modulus ( $E'$ ), loss modulus ( $E''$ ) and Tan delta ( $\tan \delta$ ) was measured. In total 3 measurements were made for each type of specimen from the same board.



**Figure 3. 12:** METRAVIB DMA 50 machine and test specimen .

## Chapter IV

### 4 Results and Discussion

#### 4.1 Part I: Primarily test results and discussion

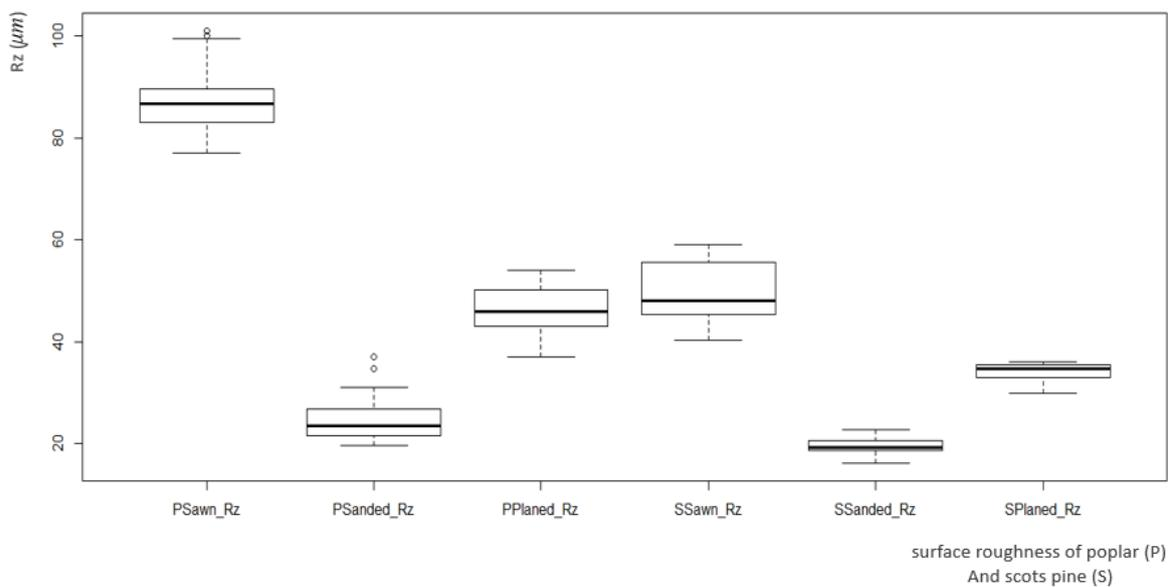
##### 4.1.1 Results

##### 4.1.1.1 Surface roughness

From the surface roughness measurements (see Table 4.1) resulted that in case of both wood species the sawn surfaces manifest the highest surface roughness, whilst the sanded surfaces are the smoothest considering  $R_z$  of the primary profiles (see Fig.4.1). Based upon  $t$ -test there is a significant difference between the roughness's of the two wood species, meaning that even machined in the same way there can be significant differences in the surface quality of the two wood species and thus in their wettability.

**Table 4. 1:** Surface roughness ( $\mu\text{m}$ ).

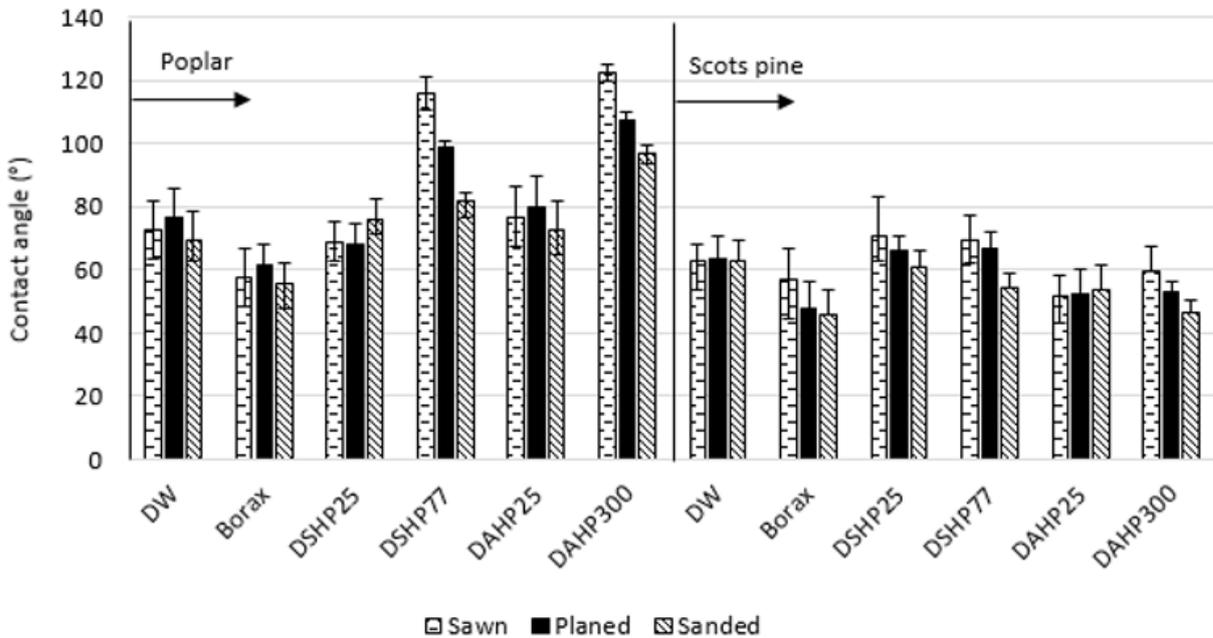
	Scots pine				Poplar							
	$R_z$		$R_a$		$R_{\text{max}}$		$R_z$		$R_a$		$R_{\text{max}}$	
	Mean	Sd	Mean	Sd	Mean	Sd	Mean	Sd	Mean	Sd	Mean	Sd
Sanded	19.37	1.69	3.05	0.24	23.27	2.53	25.23	5.30	3.20	0.20	28.52	4.82
Planed	34.05	1.92	5.39	0.33	40.65	2.66	46.65	4.90	7.07	0.76	57.69	4.97
Sawn	50.09	6.22	6.43	0.32	81.07	20.86	87.53	7.67	13.33	0.87	106	16.19



**Figure 4. 1:**  $R_z$  surface roughness of Poplar (P) and Scots pine (S) with sawn, sanded and planed surfaces.

#### 4.1.1.2 Contact angle measurement

Evaluating the wettability of the two wood species by the contact angle, the different test liquids resulted in different contact angle (Fig.4.2).



**Figure 4. 2:**Contact angle values of Poplar and Scots pine for all surfaces with all test liquids.

Based on T-test, measured with DW, all sanded, sawn and planed poplar surfaces manifested significantly higher contact angle values than the sanded, sawn and planed Scots pine surfaces, leading to the conclusion that their surface tension is expected to be lower and thus Scots pine is easier to be wetted with DW than poplar. When testing with borax the sanded, sawn and planed surfaces mostly all manifested higher contact angle on poplar than on Scots pine, only the sawn Scots pine resulted similar high contact angle as the sawn and sanded poplar samples did. The overall wettability of poplar with borax is worse than the expected wettability of scots pine. When tested with DSHP (of 25 g/l concentration) the contact angle values measured on sanded, sawn and planed poplar surfaces are mostly higher than on Scots pine surfaces. Only the sawn Scots pine serial shows as high average contact angle values as the sawn and planed poplar samples, leading to the conclusion that sanded and planed Scots pine surfaces are easier to wet with the fire retardant in scope than all other. When testing with DSHP (77 g/l concentration) the contact angle values on poplar show a significant increase (28 %), whilst the contact angle values on Scots pine remain mostly similar (3,7 %) to the one measured with the 25 g/l concentration of DSHP. This leads to conclusion that there is a strong influence of the wood species and of the concentration of

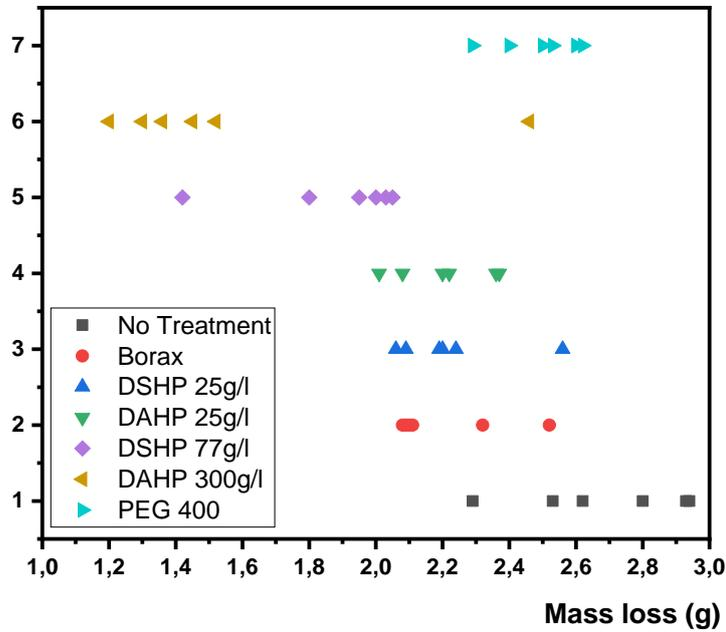
the FR as well. When testing poplar with DAHP of 25 g/l concentration, all sanded, sawn and planed surfaces manifested a significantly higher average contact angle values, than the similarly machined Scots pine surfaces. Testing poplar with DAHP of 300 g/l concentration all sanded, sawn and planed surfaces manifest significantly high average contact angle values compared to similarly machined Scots pine surfaces. The increase in concentration had different effect on poplar and on Scots pine, whilst there isn't relevant increase in the contact angle values of scots pine (less than 1 %), in case of poplar surfaces the increase of concentration results around 31 % increase in the values of the contact angle. When measuring contact angle with the higher concentrations of DAHP and DSHP, the surface roughness of both Scots pine and poplar has a significant effect. Sawn surfaces showed the highest contact angle, meaning worse wettability, followed by planed than sanded surfaces.

The measured average contact angle values result that the sanded, sawn and planed poplar surfaces showed higher contact angle values than the similarly machined Scots pine surfaces, indifferent from the test liquid they have been measured with. The lowest contact angle and thus the best wetting on poplar has been measured with borax, on sanded surface. The highest contact angle between the good wetting ones on Scots pine has been measured with diammonium hydrogen phosphate (25 g/l) on sawn surface. But when checking the relation of these two latest values, the best wetted poplar surface has significantly higher contact angle value than the DAHP tested sawn Scots pine surface. This leads to the conclusion that there is a strong influence of the wood species when measuring wettability with different FR's: Scots pine can be wetted better by the test liquid than poplar. Increasing the concentration of the DSHP and DAHP, on poplar the contact angle increased significantly, showing that a more concentrated fire-retardant wets worse the poplar surface than a less dense one. In the same time, it has been noted, that a more concentrated FR forms a more accentuated film on the surface, which raises the question how the fire retardancy is related to the thicker fire-retardant film and thus to the measured weak wetting.

#### **4.1.1.3 Experimental analysis for Fire tests:**

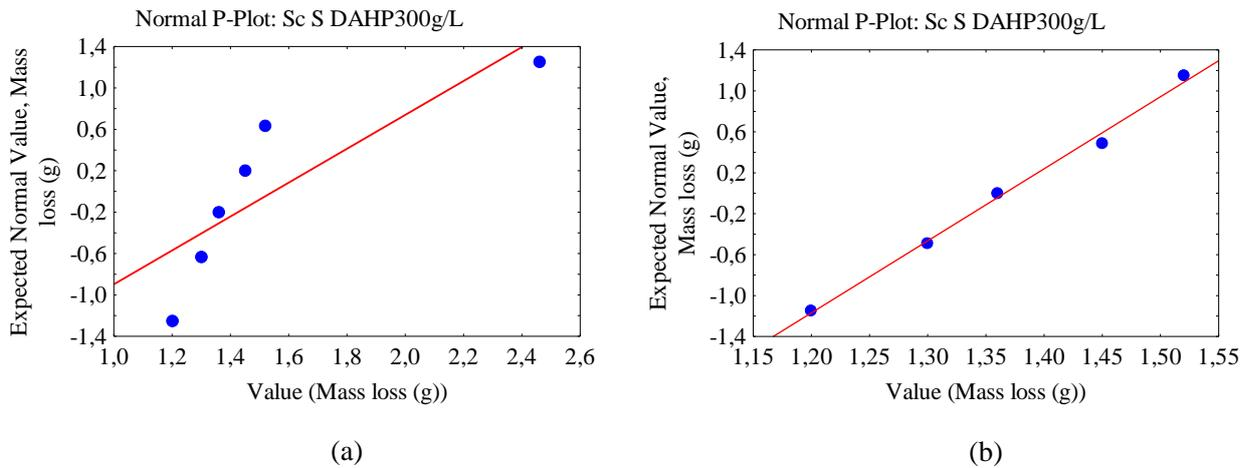
In order to detect any individual major individual experimental errors, we visualized the spread of measurement results in each series to detect signs of irregular distribution like skewness or outliers. Fig.4.3 shows a dot plot diagram for the Lindner test of sanded Scots pine. Descriptive statistics analysis with Statistica software supported our observations based on the dot plot regarding the

distribution of test results and the identification of outliers. In some cases, normal distribution was violated and a few extreme outliers were detected by using criteria given in [142]



**Figure 4. 3:** Dot plot of measurements for Linder test for sanded scots pine.

The few extreme outliers were deleted. Descriptive statistics analysis was redone in view of further evaluation of the results; as an example, see the mass loss for the Linder test on sanded Scots pine treated with DAHP 300 g/l (Fig.4.4).



**Figure 4. 4:** Descriptive statistics analysis for Mass loss for Linder test sanded scots pine species treated with DAHP 300 g/L with extreme outlier (a). Descriptive statistics analysis after deleting extreme outlier (b).

Factorial analysis of variances (ANOVA) was conducted for Linder and single flame source test in order to show effect sizes of the different pre-treatments on specimens of different types of surface preparations. The two factors were pre-treatment type at 7 levels and surface preparation at 3 levels. Results in graphical form are shown in Fig IV.1 and Fig IV.2 for Linder test and Fig IV.3 and Fig IV.4 for single flame source test. In addition, we compared the results of the different pre-treatments for the three surface preparations by drawing effect and interaction effect diagrams as can be seen in Fig IV.1 and Fig IV.2 for Linder test and Fig IV.3 and Fig IV.4 for single flame source test. Table 4.2 and Table 4.3 give the results of f-testes of significance and the effect sizes.

For calorimeter test, the two factors were pre-treatment type at 7 levels and wood species were used at 2 levels. Results in graphical form are shown in Fig IV.5 and the interaction diagrams compare the results of the different pre-treatments for the two wood species see Fig IV.5. Table 4.4 lists the results of f-testes of significance and the effect sizes. However, because of lack of homogeneity of variances in most cases, the p-values calculated cannot be taken as true; nevertheless, facts of significance were indicated and the trends of influences of pre-treatments can be accepted. In order to obtain reliable evaluation results, pairwise comparisons were conducted by applying the “Newman-Keuls” test.

**Table 4. 2:** Univariate Tests of Significance, Effect Sizes, and Powers for Scots pine and poplar mass loss.

Effect	SS	Degr. of freedom	MS	F	P	Partial eta-squared	non-centrality	observed power alpha=0.05
Intercept	544.0546	1	544.0546	16961.91	0.000000	0.993964	16961.91	1.000000
Sc Pre-treatment	16.8074	6	2.8012	87.33	0.000000	0.835726	524.00	1.000000
Sc Surface	0.5764	2	0.2882	8.99	0.000253	0.148557	17.97	0.970423
Sc Pre-treatment* Sc Surface	1.9232	12	0.1603	5.00	0.000002	0.367938	59.96	0.999901
Error	3.3037	103	0.0321					
Intercept	888.4032	1	888.4032	11117.16	0.000000	0.990732	11117.16	1.000000
P Pre-treatment	52.9347	6	8.8225	110.40	0.000000	0.864302	662.41	1.000000
P Surface	0.0287	2	0.0144	0.18	0.835773	0.003444	0.36	0.077228
P Pre-treatment* P Surface	4.6654	12	0.3888	4.87	0.000003	0.359534	58.38	0.999861
Error	8.3109	104	0.0799					

**Table 4. 3:** Univariate Tests of Significance, Effect Sizes, and Powers for Scots pine and poplar Burning length.

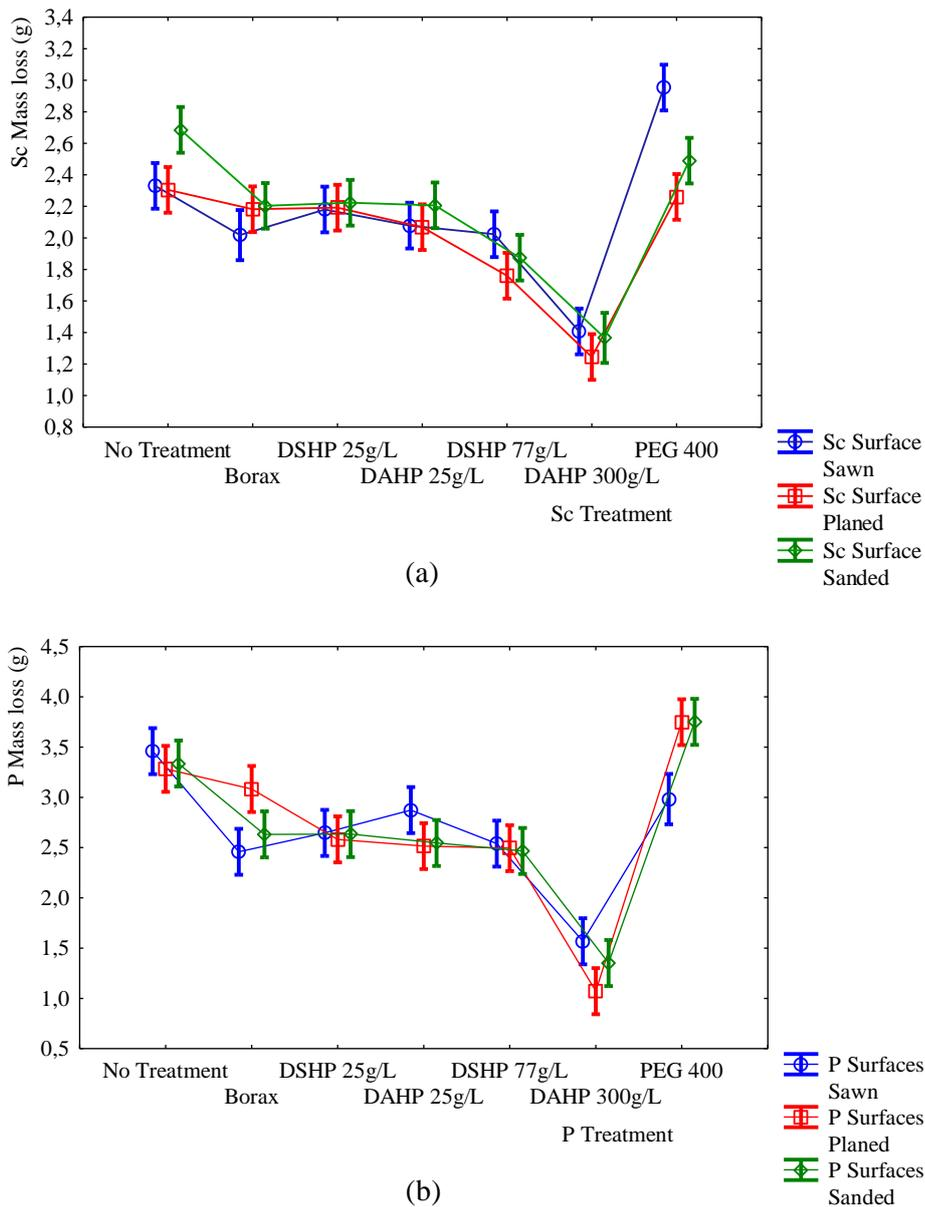
Effect	SS	Degr. of freedom	MS	F	P	Partial eta-squared	non-centrality	observed power alpha=0.05
Intercept	3807.541	1	3807.541	9857.691	0.000000	0.989461	9857.691	1.000000
Sc Pre-treatment	180.165	6	30.028	77.741	0.000000	0.816256	466.447	1.000000
Sc Surface	9.413	2	4.707	12.186	0.000017	0.188381	24.371	0.994804
Sc Pre-treatment* Sc Surface	7.212	12	0.601	1.556	0.116208	0.150971	18.671	0.788611
Error	40.556	105	0.386					
Intercept	4173.984	1	4173.984	10418.79	0.000000	0.990117	10418.79	1.000000
P Pre-treatment	184.613	6	30.769	76.80	0.000000	0.815869	460.82	1.000000
P Surface	1.434	2	0.717	1.79	0.172083	0.033276	3.58	0.366935
P Pre-treatment* P Surface	15.456	12	1.288	3.22	0.000598	0.270591	38.58	0.991502
Error	41.665	104	0.401					

**Table 4. 4:** Univariate Tests of Significance, Effect Sizes, and Powers for scots pine, poplar, and date palm leaflet Combustion heat.

Effect	SS	Degr. of freedom	MS	F	P	Partial eta-squared	non-centrality	observed power alpha=0.05
Intercept	20398.99	1	20398.99	43289.22	0.000000	0.998708	43289.22	1.000000
Pre-treatment	814.54	6	135.76	288.09	0.000000	0.968620	1728.57	1.000000
Wood Species	85.54	1	85.54	181,52	0.000000	0.764233	181.52	1.000000
Pre-treatment*Wood Species	21.60	6	3.60	7.64	0.000005	0.450104	45.84	0.999625
Error	26.39	56	0.47					

According to the standard MSZ 9607/1-83 [138] for Lindner tests, for absolute protection, mass loss has to be less than 1.5 g. As can be seen in (Fig.4.4), only DAHP with a concentration 300 g/l fulfilled the criterion of mass loss for both poplar and Scots pine. For poplar, mass loss

was reduced by 54.91 % for the sawn surface, by 67.37 % for the planed surface, and by 59.45 % for the sanded surface, while the decreases for Scots pine were 39.90 % for the sawn surface, 46.08 % for the planed surface, and 42.53 % for the sanded surface. After completing the t-test, DAHP with 300 g/l concentration had the lowest mass loss among all wood specimens, while PEG 400 had the highest mass loss.



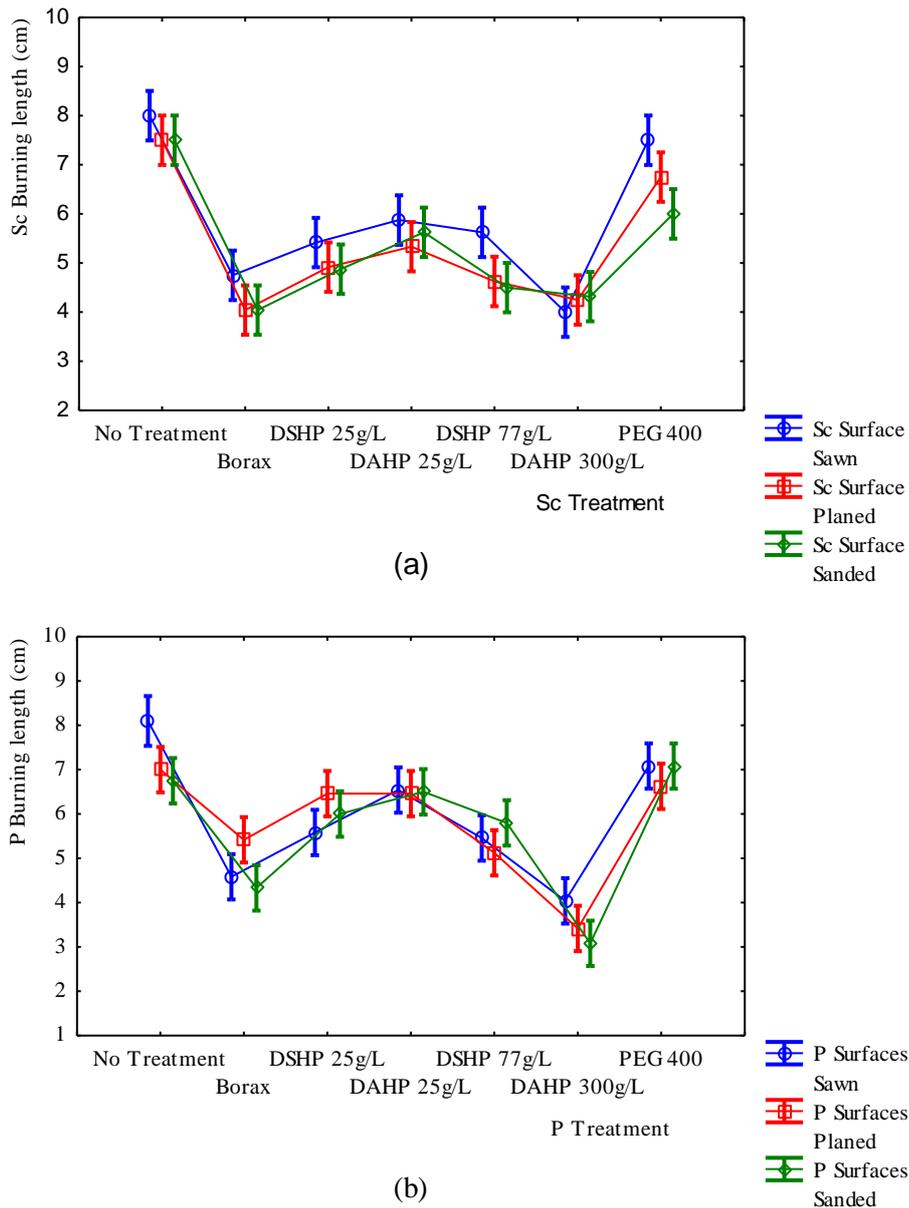
**Figure 4. 5:** Mass loss (g), Scots pine results (a), results of poplar (b).

The mass loss when various surfaces (sanded, planed, and sawn) were compared was significantly different in Scots pine. In contrast, this difference in poplar was slight. For Scots pine, the planed surface had the lowest mass loss, while the sanded and sawn surfaces had the highest

mass loss. The latter two surfaces revealed no substantial differences between them with most pre-treatments. On the contrary, the planed surface of poplar has the highest mass loss and the three surface preparations had no significant differences with most pre-treatments. In general, there was no marked difference between surface preparation on poplar and Scots pine. For poplar, all specimens treated with fire retardants, with the exception of those treated with PEG 400, had significantly lower mass loss than the untreated wood specimens, which means almost all fire retardants were effective in increasing the fire resistance of the wood specimens. The mass loss of all Scots pine specimens treated with fire retardants was significantly lower than in untreated samples except for samples treated with borax and DSHP 25 g/l on planed surface and PEG 400 on all surfaces. With respect to fire retardant concentrations, specimens treated with DAHP 25 g/l had a notably higher mass loss than the samples treated with DAHP 300 g/l in both wood species. This indicates that the concentration had a positive effect on the performance of fire retardants. Concerning DSHP, there was no marked difference of mass loss between the concentration 25 g/l and 77 g/l in Scots pine, while in poplar the difference was significant. This implies that efficiency of concentration was influenced by various factors like the wood species itself and the fire retardant used. Comparing the mass loss of wood specimens with different surface preparations showed that for poplar there was no noteworthy difference while for Scots pine there was significant difference between planed and sanded surfaces and between sawn and sanded surfaces. ANOVA indicated that all pre-treatments affected mass loss on both wood species, but surface preparations only affected Scots pine.

All specimens fulfilled the criteria according to the EN ISO 11925-2:2011 standard [16] as none of the burning lengths exceeded 15 cm see (Fig.4.6). DAHP with concentration of 300 g/l had the lowest burning length among all treated and untreated specimens of both wood species. This resulted in burning lengths that were reduced by 50 % on the sawn surface, 43.46 % on the planed surface, and 42.53 % on the sanded surface for Scots pine, and by 47.87% on the sawn surface, 51.28 % on the planed surface, and 45.62 % on the sanded surface for poplar as compared to the allowable value. Borax also achieved good results, especially on Scots pine, in which it decreased burning length by 40.62 % on the sawn surface and by 46.13 % for both planed and sanded surface. For poplar, borax decreased the burning length by 40.90 %, 22.71 %, and 35.85 % for sawn, planed and sanded surface respectively. All specimens treated with fire retardants had a lower burning length than untreated samples, but PEG 400 had almost the same results as untreated wood specimens. This means that PEG 400 is ineffective as a fire retardant for both poplar and Scots pine. The burning lengths of wood specimens prepared with different surface preparations

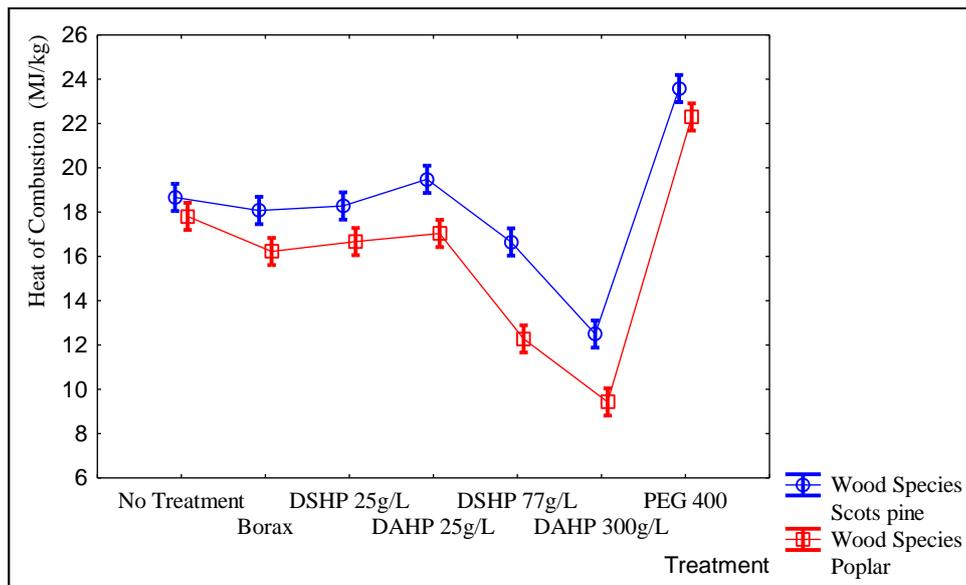
were compared with the t-test; results indicated no significant difference in Scots pine while in poplar there was significant difference between planed and sawn surfaces and among sawn and sanded surfaces. According to ANOVA results, pre-treatments do have an effect on burning length on both wood species, while influence of surface preparation was important only in Scots pine. The interaction between pre-treatment and surface had no effect on Scots pine specimens.



**Figure 4. 6:** Burning length (cm), Scots pine results (up), results of poplar (down).

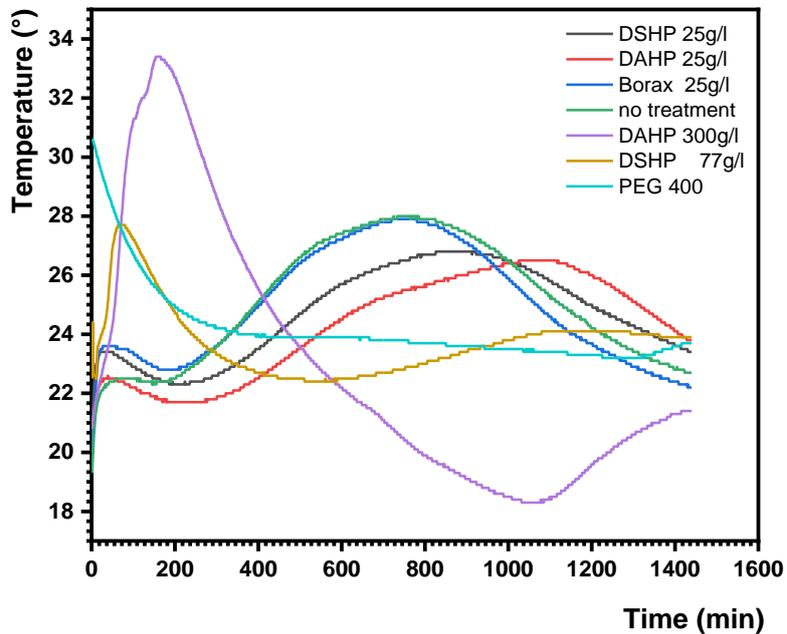
Calorimeter test results (see Fig.4.7) showed that the heat of combustion for poplar specimens treated with DAHP 300 g/l was significantly lower than that of Scots pine, while PEG 400 had the highest heat of combustion, which was even higher than that of the untreated wood

specimens. Specimens treated with DSHP 77 g/l had the second lowest heat of combustion. Poplar and Scots pine specimens treated with DSHP 25 g/l had substantially higher heat of combustion than the specimens treated with DSHP 77 g/l, especially in poplar. With poplar and Scots pine specimens treated with DAHP 25 g/l, the heat of combustion was significantly higher than it was in specimens treated with DAHP 300 g/l, which indicated that the concentration of fire retardants had an effect on the heat of combustion. No noteworthy difference emerged between specimens treated with borax and specimens treated with DSHP 25 g/l for any of the two wood species. Significant differences in heat of combustion between all treated specimens treated with various fire retardants with the exception of borax. Among all treated or untreated specimens, poplar had the lowest heat of combustion except with PEG 400. Among all the fire retardants, DAHP 300 g/l and DSHP 77 g/l performed the best and also displayed the lowest heat of combustion. For both, the lowest heat of combustion was measured in poplar, while the highest was measured in Scots pine. DSHP 300 g/l reduced the heat of combustion for poplar by 47.05 % and by 33.01 % for Scots pine. DSHP 77 g/l, decreased the heat of combustion by 31.04 % for poplar and by 10.77 % for Scot spine. According to t-test results for untreated wood specimens, poplar showed no notable difference compared to Scots pine. Considerable differences between the heat of combustion in the treated wood species samples emerged, with poplar having the lowest while Scots pine the highest heat of combustion. DAHP 300 g/l concentration and DSHP 77 g/l concentration treated poplar had the lowest value. ANOVA analysis indicated that both pre-treatment and wood species have an effect on heat of combustion.



**Figure 4. 7:** Heat of Combustion (MJ/kg) For Scots pine and poplar.

#### 4.1.1.4 Hydration test

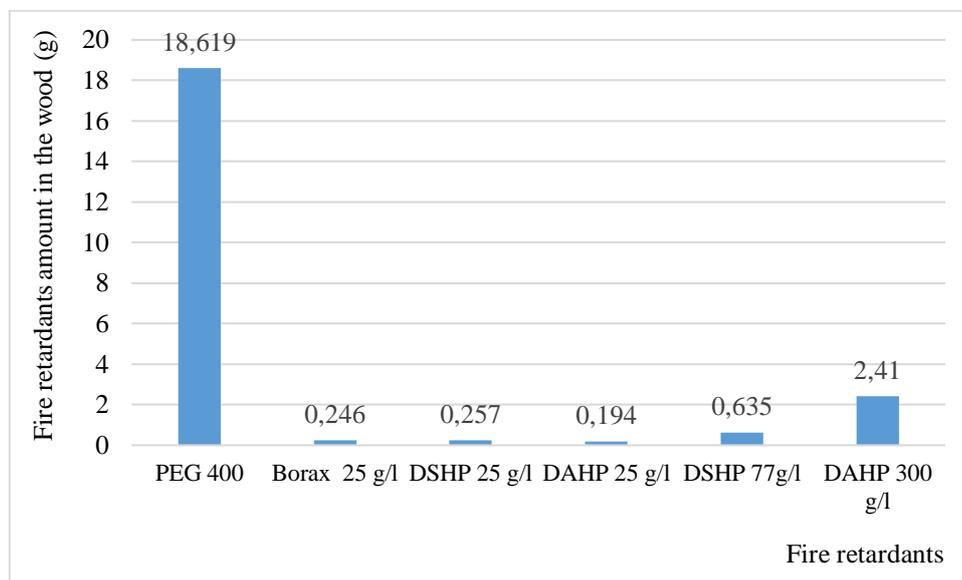


**Figure 4. 8:** Hydration test of cement treated with different fire retardants, Temperature change within 24 hours of cement curing.

In a normal curve, a small rise appears in the initial state of the cement hydration process. Following this, the curve becomes constant before rising at the end when the cement reaches its hardening stage. The hydration test indicated that all specimens treated with fire retardants were cured after 24 hours, with the exception of PEG 400-treated specimens. The best result was achieved with borax, as the curve of temperature change during cement curing was similar to the untreated cement mixture. For the other fire retardants, the small concentration (25 g/l) achieved the same results as the high concentration with high temperature peak in the beginning of the cement curing, followed by a decrease in temperature. On the other hand, the PEG 400 curve had no increase in temperature from the initial stage of the cement hydration process; this prevented the cement from curing. The specimen treated with PEG 400 did not reach the hardening stage even after 6 months of drying, which means PEG 400 is unsuitable for CBPB production, see Fig.4.8. According to the results, PEG 400 will increase the setting time of cement hydration and even prevent it from curing, while the high concentration of DAHP and DSHP will increase the setting time by a short period, leading to a worsening of the compatibility of wood and cement by adversely affecting mechanical properties and initial board strength. On other hand, borax, DAHP

and DSHP with 25 g/l concentration are expected to have no effect on the setting time of cement hydration and to have no effect on the mechanical and initial board strength.

Based on hydration test curves, DAHP 300 g/l and DSHP 77 g/l have big influence on cement curing compared with DAHP and DSHP with 25 g/l. When compare the curves results with the drying of pre-treated particles of wood during 24h it was found that PEG 400 does not dry at all while DAHP 300 g/l and DSHP 77 g/l drying ratio is less than the lower concentration 25 g/l see (Fig 4.9). It may conclude a relation between effect of fire retardants on cement curing and particle drying.



**Figure 4. 9:** Fire retardant amount in treated wood particles after 24 hours of drying.

#### 4.1.2 Discussion

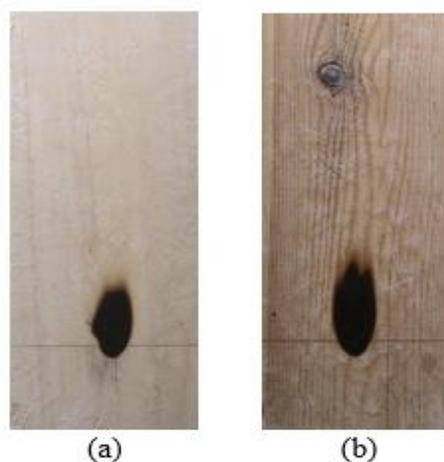
Surface roughness results indicated that poplar had higher surface roughness than Scots pine; which aligns with results in the literature [143]. Nevertheless, the results for surface roughness of specimens used in this study were lower than the results found in the literature. The difference between poplar and Scots pine was caused by the difference of the anatomical structure of wood species. In addition, the density of poplar was lower ( $320 \text{ kg/m}^3$ ) than that of Scots pine ( $500 \text{ kg/m}^3$ ). There are many factors that affect the surface roughness of wood, like the machining, moisture content, density, and anatomical structure [133], [144], [145]. Since all samples were machined in the same manner and had the same moisture content, density and anatomical structure were the only remaining influencing factors.

According to wettability test results [137], among all fire retardants Borax has the best wettability, but offers the weakest fire resistance. DAHP 300 had the worst wettability but the best fire resistance, followed by DAHP 77. These two fire retardants are from phosphorus compounds. Regarding wettability of the investigated wood species: scots pine is easier to wet compared with poplar. Only our DW results are comparable with other authors results, and this result was the opposite to what Oberhofnerova and Panek stated after similar measurements performed with DW [129] but the fire resistance of poplar is better than the one of scots pine. When evaluating the effect of concentration resulted, that higher concentration decreased the wettability but in the same time, an increase of fire resistance was observed. To lower concentrations of the same FR the contrary was typical.

The increase in contact angle indicates the increase in hydrophobicity when the contact angle is measured using very hydrophilic liquid (i.e. water), since larger contact angle means less wetting of the surface by water [146], [147]. Similarly, and according to our original presumption, low contact angle of the FR means good wettability, especially if the contact angle is lower or equal to  $30^\circ$  [148]. This would mean in case of FRs that they could spread easily and perhaps penetrate well into the wood surface. This presumption was based on the idea, that good wetting FRs cover uniformly the surface thus offer a better protection than a bad wetting liquid, but this theory has never been tested before. The actual test results did not support our original presumption. Contrary they show that high contact angles (suggesting bad wetting) of a concentrated FR, can be associated with an enhanced fire resistance. A possible reason of this phenomena may be, that the more concentrated the FR the thicker the layer of FR, which improves flame resistance by its physical presence in the upper wood tissue layer. During a bad wetting the water-soluble FR does not penetrate the wood structure, but mostly remains at the surface, when the dissolving water evaporates, FRs remains deposited close to the surface. Thus, the ignition time of the FR treated wood surface improves. This explanation is supported by the fact, that the same FR at low concentration wets well the surface, thus penetrates deeper, there isn't relevant material deposition close to the surface and accordingly its ignition is not that much blocked at the level of the surface. On the other hand, at high concentrations this FR deposition becomes more and more visible in form of a FR layer, which is not a problem in case of wood particles mixed with cement, but would be a problem in case of solid wood surfaces.

Phosphorus compounds are well-known fire retardants for wood because they reduce thermal degradation [88]. They form acids that decrease the temperature of wood [89] and as a

result increase its dehydration and char formation [90], [91]. DAHP and DSHP barely improved the fire resistance at lower concentration of fire retardants in each fire test and for all wood species, both in particle and solid wood forms. When the concentration was increased, they became very effective fire retardants especially on poplar. Both DAHP and DSHP in high concentrations formed a thin white layer on the surface of treated specimens, which worked as a protective layer against fire; (see Fig.4.10).



**Figure 4. 10:** (a) Sample of poplar treated with DAHP 300 g/l. (b) Sample of Scots pine treated with DAHP 300 g/l. Both figures show a thin film on the surface of samples that is caused by DAHP 300 g/l.

The thin layer was created because of the low wettability of the used fire retardants on wood. The thin layer was created because of the bad wettability of the used fire retardants on wood [137]. These results confirm those noted in previously published literature [149]–[151].

DAHP with a concentration of 300 g/l had the best results in all fire tests. When measuring the heat of combustion of Scots pine treated with the DAHP 300 g/l, results were the same as the results found by Terzi et al [152]. The DAHP and DSHP were suitable fire retardants for wood, but only in high concentrations. Borax is one of the known boron compounds. Bysal et al [95] reported that borax had the advantage of suppressing fire propagation, but also promoted smouldering. Therefore, it is usually recommended to use borax with boric acid, which suppresses smouldering. In this study, borax was first tested with the Lindner test, where mass loss was measured. Borax did not improve the fire resistance of the wood species. The same results were observed with the heat of combustion during the calorimeter test. Both tests offered insights into wood smouldering. For testing fire propagation, the single flame source test was performed to check the burning length. In this test, borax had one of the best results among all the tested fire retardants, which means that borax is good at suppressing fire propagation. To be an effective fire

retardant, borax has to be applied together with the boric acid because borax alone will not protect against fire. Borax always had lower fire retardation than DAHP 300 g/l on poplar and Scots pine. Demir and Aydin tested these fire retardants on poplar and Scots pine and found that the thermal conductivity of DAHP is higher than the thermal conductivity of Borax. A fire retardant's thermal conductivity allows chemicals to absorb heat, thus preventing the ignition of the wood surface. Since DAHP has higher thermal conductivity, it will impart better fire retardation than Borax. PEG is not known as a fire retardant, but one of the research [101] reports proved PEG to be an effective fire retardant, but only if its molecular weight was lower than 600. In this study, PEG 400 was used, but in almost all of the fire tests completed, the wood samples treated with PEG performed even worse than the untreated samples. This means that PEG 400 is not a suitable fire retardant for wood. In addition, PEG 400 is unsuitable for CBPB production because the hydration test of cement with the use of PEG 400 showed that the cement could not be cured even after 6 months.

Several FR's have been tested in order to find the most convenient ones for improving the fire resistance of poplar and Scots pine particles: Borax ( $Na_2B_4O_7$ ), DSHP ( $Na_2HPO_4$ ), DAHP ( $(NH_2)_4HPO_4$ ). The best fire resistance has been achieved on Poplar, and in case of both species at high concentrations of DAHP and DSHP. When testing wettability of sanded, sawn and planed poplar I 214 (*Populus cv. euramericana I214*) solid wood surfaces in comparison with the wettability of Scots pine (*Pinus sylvestris*) by contact angle measurement we have found that poplar's wettability is worse than the one Scots pine in each case, contact angle values of Poplar have been significantly higher, irrelevant from machining type relative to Scots Pine. With increasing concentration of the FR, the wettability of poplar gets worse, whilst the wettability of Scots pine remains mostly unchanged. On the other hand, with increasing concentration of FR the fire resistance of poplar improves considerably relative to Scots pine. This contradicts our original presumption. We can state that good wetting FR, doesn't result good fire resistance. Wettability has been found to be invers proportionate to fire retardancy. Results also showed that high concentration of the FR resulted significant differences in the contact angle values of sanded, sawn and planed poplar surfaces, indicating that roughness has a strong influence when the concentration of the FR is high. The relevance of these results is in pointing out, that no good conclusion can be deduced from the contact angle values regarding fire retardancy, if the measurement is not done with the FR's themselves. High concentration DAHP and DSHP are good fire retardants for both poplar and scot spine, and their introduction in the CBPB production

improves the fire retardancy of these boards. Surface roughness hadn't strong influence which could be neglected.

As fire retardants, DAHP and DSHP in high concentrations obtained the best results in all wood species. Borax displayed excellent flame spread prevention qualities and had no adverse effect on cement curing. On the other hand, PEG 400 had the worst fire resistance and it prevent cement from curing, make it not suitable for CBPB production. DSHP and DAHP with high concentration negatively influenced cement curing, which lead to decreases in the mechanical properties of CBPB. Nevertheless, using the proper amounts of curing agents can alleviate this problem. However, with decreasing the DAHP and DSHP concentration to 25 g/l, cement-setting time of cement hydration increased and it is expected to have no effect on mechanical properties of CBPB.

Thus, it can be concluded that fire retardants containing the phosphorus compounds DSHP and DAHP were not only effective fire retardants for wood, but could also be introduced in CBPB production. While these compounds enhance the fire resistance of wood, they affect the curing of cement slightly. They must be used at high concentrations for effective fire protection. Since particles are used in CBPB production particles, better results can be expected with poplar. After analysing the tests results it is recommended to make CBPB made of DAHP 300 g/l, DSHP 77 g/l and Borax 25 g/l.

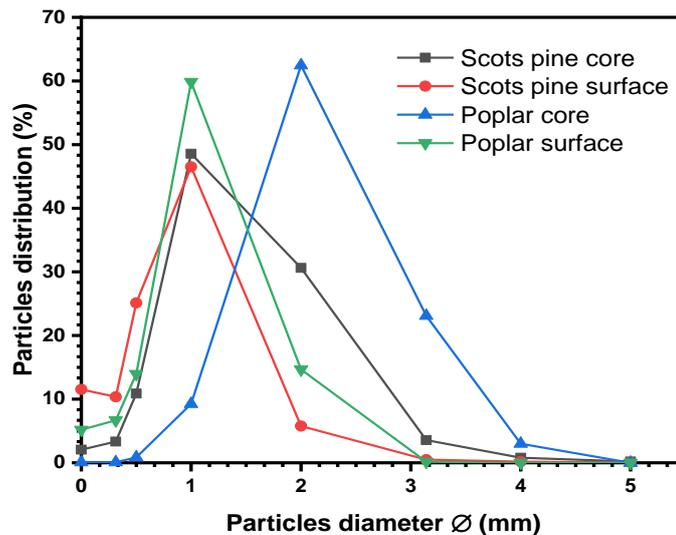
## **4 Part 2: CBPB test results and discussion**

### **4.2.1 Properties of wood particles**

#### **4.2.1.1 Wood particles size**

Particles are used with cement to increase MOR and to improve heat-insulating properties. Previous studies pleaded that particle size and geometry effect on mechanical properties is the same as resin-and cement-bonded particleboards. New researches proposed that the cement bonded board needs a larger particle size than resin-bonded panels. Particleboards with large and thin wood particles are stiffer, firmer, and more dimensionally stable. Long particles produce boards with high strength, while small particles are used for a more compact matt structure and reduce space and irregularities [153]. In this research, CBPB's with three-layers comprising of 0-2 mm thick particles for surface layers and 2-5 mm for the core layer. The core layer was made of large particles to give the boards high strength. The two-layer surface made of small particles to give CBPB's a more compact matt structure with a smooth surface. Since Scots pine particles

brought from Falco company, and poplar particles made in university, which means they made by different hammer mill machines. The particle size distribution of Scots pine and poplar will differ. The particle size distribution of Scots pine and poplar will not be the same. Fritsch Analysette particle analyzer measured the quantitative wood particle size distribution of poplar and Scots pine. Figure 4.11 represents Scots pine and poplar particle Size distribution that used for surface and core layers.



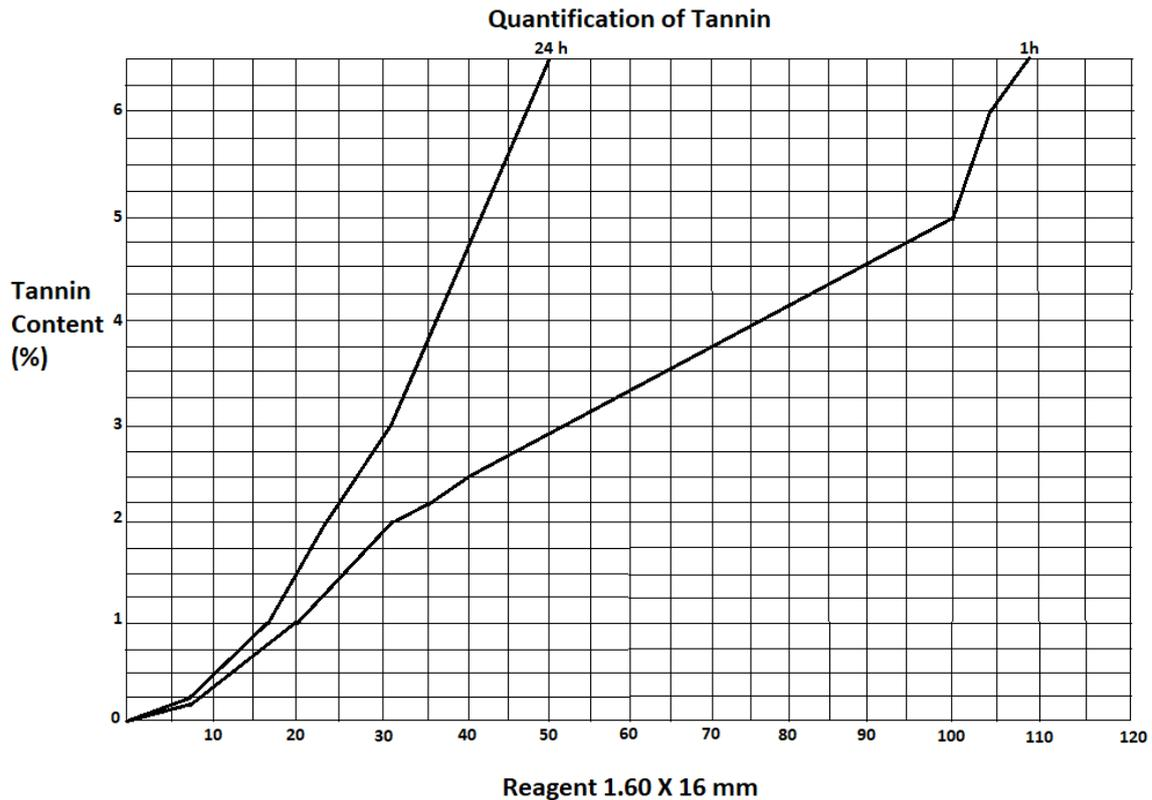
**Figure 4. 11:** Scots pine and poplar particle Size distribution that used for surface and core layers.

Among both core and surface layer particles, it looks that poplar has larger particles than Scots pine. For the core layer, the particle distribution (see Figure 5.1) shows that 62.46 % of the particles are 2 mm thick while 23.1 % is 3.14 mm thick in the case of poplar, while for Scots pine, 30.62 % of particles are 2 mm thick and 48,56 % are 1 mm thick. For surface layer particles, poplar has 59.86 % of particles 1 mm thick, 14.66 % 2 mm thick, 13.96 % 0.5 mm thick, and sawdust 0 mm is 5.18 %. While Scots pine has 46.5 % of particles with 1 mm thick, 25.12 % 0.5 mm thick, 10.36 % 0.314 mm and 11.52 % sawdust 0 mm.

#### 4.2.1.2 Sugar and tannin content

The sugar content is determined by adding 1 ml of Fehling's solution to the prepared solution and boil it for 2 min. When the solution turns to blue or bluish-green, it means contain copper sulfate, and the sugar content is lower than 0.5 %. BISON technology of Falco. Zrt imposes that wood sugar content has to be max=0.5 % to be used in CBPB production [154]. Both Scots pine and

poplar I214 used in this study found that they have sugar content below 0.5 % that fulfilled requirements. For tannin content, Scots pine and poplar I214 were kept in tubes with a diameter of 16 mm for 24 hours, and the tannin content read based on Fig.4.12. Scots pine tannin content found 0.45 %, while the tannin content of poplar I214 is 0.25 %, which is lower than it found by Csaba [154] = 0.65 %.



**Figure 4. 12:** Tannin content diagram.

Scots pine has more tannin content than poplar I214, which is expected based on previous literature where the  $C_A$  factor of Scots pine is higher than of poplar that means Scots pine has more extractives than poplar [155]. In general, both wood species are found suitable for CBPB production.

## 4.2.2 Hygroscopic and Mechanical properties of CBPB's:

### 4.2.2.1 Fulfilment of standard requirements of the Produced CBPB:

#### 4.2.2.1.1 MOR and Density

For CBPB's made of Scots pine, the board made of untreated wood particles fulfilled the standard requirement with MOR= 9,54 Mpa with using 2 % of SS from cement weight. On the other hand,

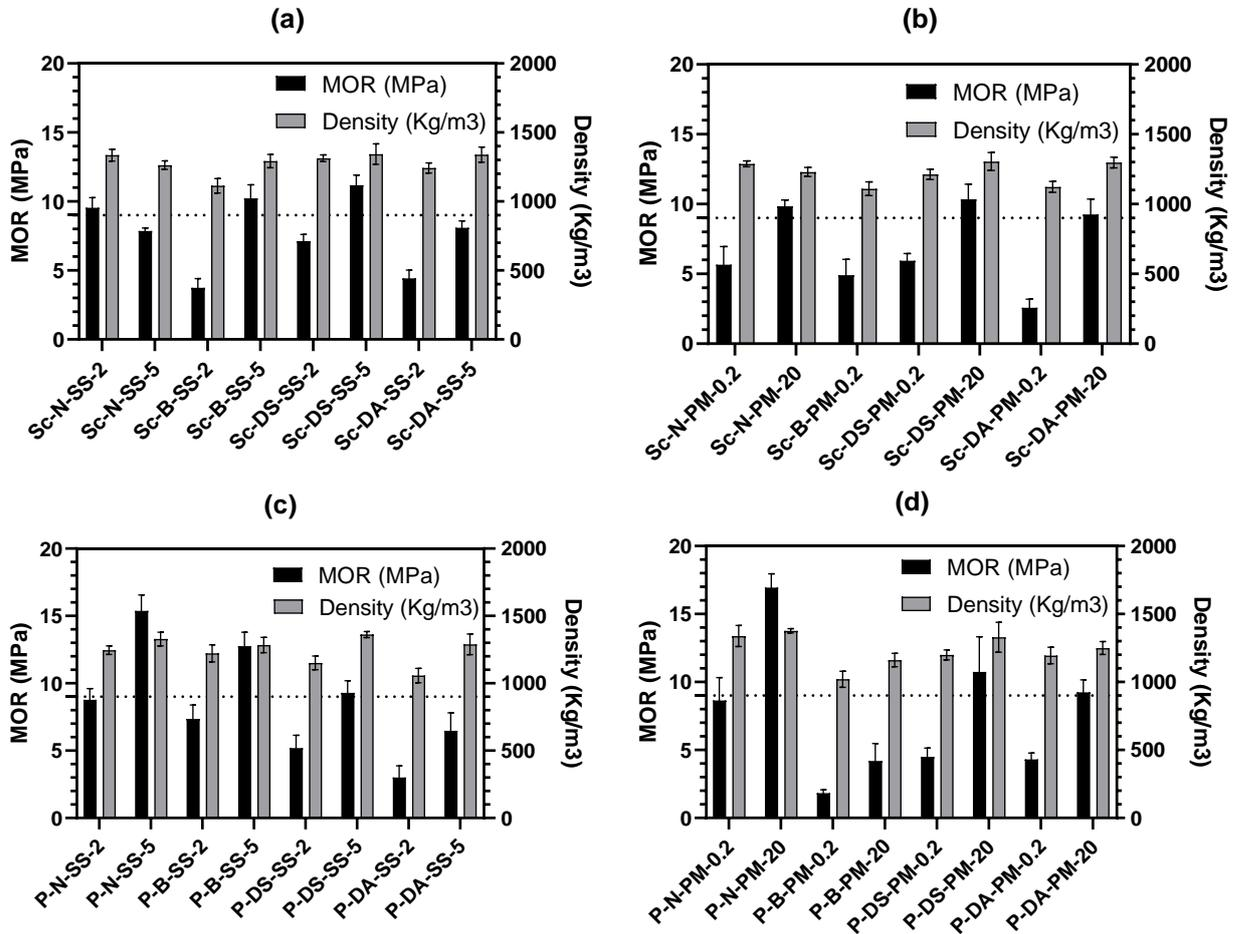
the board made with treated particles has a lower MOR. Board (SC-B-SS-2) has 62,63 % lower MOR than the control one, while board (SC-DS-SS-2) has 25.37 % lower MOR than the control board (SC-N-SS-2), for the board (SC-DA-SS-2) MOR drop with 53.52 %, none of the CBPB with FR's pre-treatment fulfilled the requirement. After adding 5 % of SS from cement weight, MOR dropped by 17.71 % for the untreated board (SC-N-SS-5) to 7.85 Mpa and standing out of the standard. MOR of CBPB's with treated particles increased by 63.37 % for (SC-B-SS-5), 39.20 % for (SC-DS-SS-5), and 49.67 % in the case of (SC-DA-SS-5). Using 5 % of SS boards made of particles treated with borax fulfilled the standard requirement by 10.22 Mpa and DSHP 77 g/l by 11.17 Mpa. However, DAHP 150 g/l almost reaches standards with MOR= 8.81 Mpa while the standards requirement is 9 Mpa see Fig.4.13. (a).

For boards made of Scots pine particles with 0.2 % of (PDDA+MM), the untreated board did not meet the requirement with MOR= 5.66 Mpa. Board (SC-DS-PM-0.2) had MOR= 5.99 Mpa, which similar to the untreated one. (SC-DA-PM-0.2) has lower MOR than the control CBPB with 54.62 % while borax pre-treatment board (SC-B-PM-0.2) did not fulfill the requirement with MOR= 4.90 Mpa see Fig.4.13. (b). By increasing the (PDDA+MM) to 20 % control specimens MOR increased by 42.48 %, boards (SC-DS-PM-20) increased with 42.59 %, and (SC-DA-PM-20) MOR increased with 72.26 % upgrading the CBPB's to the standard requirements. However, borax pre-treatment with 20 % of (PDDA+MM) prevents the board from curing.

For boards made of poplar particles with 2 % of SS, the CBPB made of untreated wood particles did not fulfill the standard requirement with MOR= 8.77 Mpa. Also, the boards made with treated particles have even lower MOR. (P-B-SS-2) has 23.26 % lower MOR than (P-N-SS-2), while (P-DS-SS-2) has 16.10 % lower MOR than the untreated for (P-DA-SS-2) bending strength drop with 70.82 %. After adding 5% of SS from cement weight, MOR increased by 55.16 % for the untreated board with 15.38 Mpa and fulfilling the standard requirement. CBPB's made of treated particles, MOR increased by 51.96 % for (P-B-SS-5), 35.92 % in case of (P-DS-SS-5), and 67.27 % in case of (P-DA-SS-5). Using 5 % of SS boards made of particles treated with borax fulfilled the standard requirement by 12.70 Mpa and DSHP77g/l by 9.28 Mpa, but DAHP 150 stands out of standard with 6.47 see Fig.4.13. (c).

For boards made of poplar particles with 0.2 % of (PDDA+MM), the untreated board did almost meet the standard requirement with 8.64 Mpa. FR's pre-treatments decreased MOR of the CBPB's for (P-B-PM-0.2) by 78.82 %, for (P-DS-PM-0.2) by 51.96 and 50.06 % in case of (P-DA-PM-0.2). By increasing the (PDDA+MM) to 20%, control samples MOR increased by 49.01

%, (P-DS-PM-20) increased with 58.22 %, and (P-DA-PM-20) increased with 53.31 % upgrading the boards to the standard requirements. However, for borax pre-treatment (P-B-PM-20) with 20 % of (PDDA+MM) board cured but had low MOR 4.18 Mpa see Fig.4.13. (d)



**Figure 4. 13:** MOR (MPa) and Density (%) of CBPB (a) CBPB made of Scots pine with SS as additive, (b) CBPB made of Scots pine with PDDA+ MM additive as additive, (c) CBPB made of poplar with as additive SS, (d) CBPB made of poplar with PDDA+ MM additive as additive.

**4.2.2.1.2 IBS and TS**

For CBPB’s made of Scots pine particles with 2 % of SS, the control board (SC-N-SS-2) fulfilled the standard requirement, which is 0.5 Mpa by IBS=0.65Mpa. Borax (SC-B-SS-2) has decreased the IBS by 60 %, while DSHP77g/l (SC-DS-SS-2) has reduced it by 47.69 %. For a board with DAHP150g/l (SC-DA-SS-2), IBS decreased by 67.69 %. After adding 5% of SS from cement weight, the untreated board IBS becoming 0.23 Mpa fulfilling the standard requirement. IBS of boards made with treated particles increased by 55.93 % for (SC-B-SS-5), 35.77 % for (SC-DS-

SS-5), and 41.66 % in the case of (SC-DA-SS-5). Using 5% of SS boards made of particles treated with borax and DSHP77g/l fulfilled the standard requirement, while DAHP 150 stands out of standard with IBS=0.36 see Fig.4.14(a).

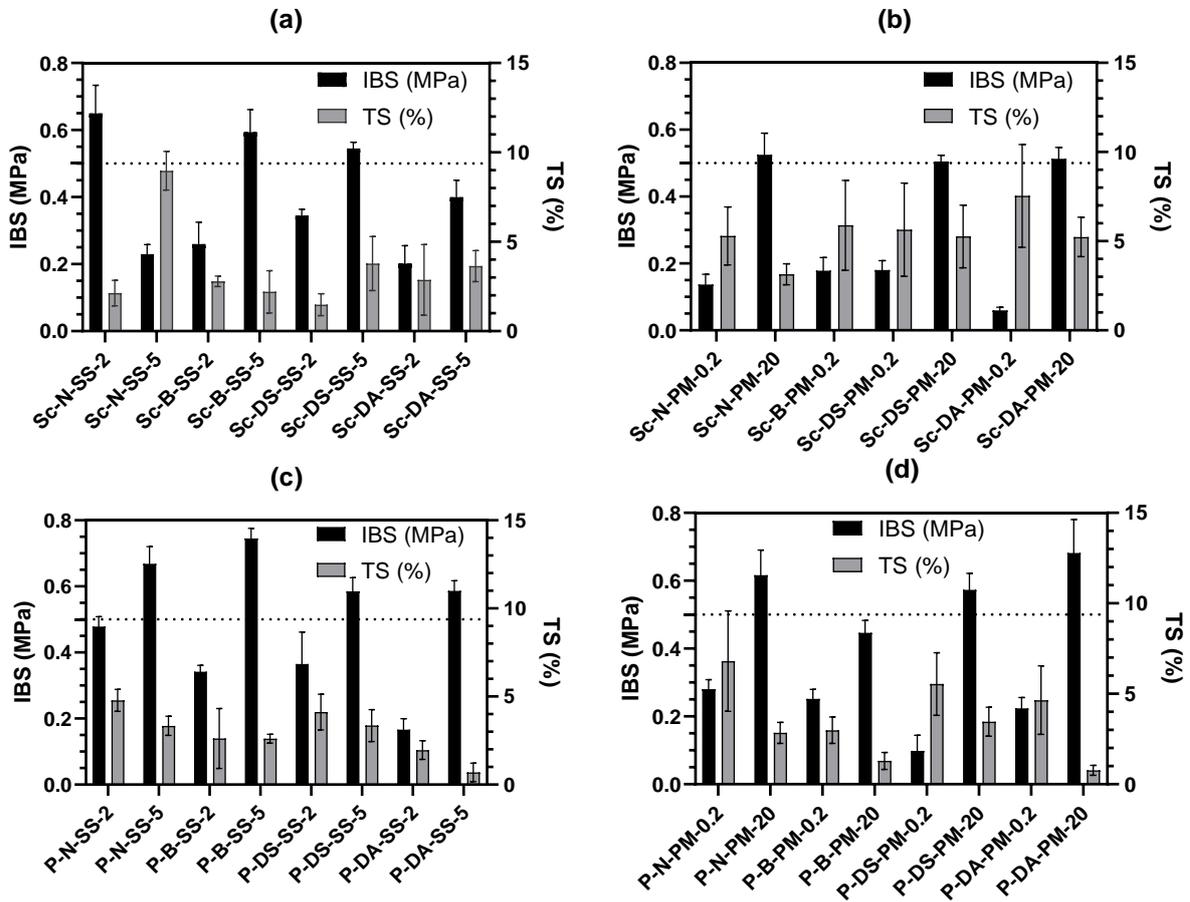
For boards made of Scots pine particles with 0.2% of (PDDA+MM), the untreated board did not meet the standard requirement with IBS= 0.16 Mpa. Fire retardant's pre-treatments decreased IBS of the CBPB's. Board (SC-B-PM-0.2) had IBS = 0.15, (SC-DS-PM-0.2) IBS = 0.18 MPa. IBS of (SC-DA-PM-0.2) = 0.07 MPa. By increasing the (PDDA+MM) to 20 %, control specimens IBS increased to IBS=0.46 MPa, IBS of (SC-DS-PM-20) increased by 70.58 %. IBS of (SC-DA-PM-20) increased by 86.54 % increases the IBS of the boards to reach the standard requirements. However, borax pre-treatment with 20 % of (PDDA+MM) board did not cure.

For CBPB's made of poplar particles with 2 % of SS, the board made of untreated wood particles did not fulfill the standard requirement IBS=0.48Mpa. Moreover, the CBPB's made with treated particles has even lower IBS. Borax (P-B-SS-2) has decreased the IBS by 29.16 %, while DSHP77g/l (P-DS-SS-2) decreased it by 22.92 %. For a board with DAHP150g/l (P-DA-SS-2), IBS decreased by 64.58%. After adding 5 % of SS from cement weight, the untreated board IBS becoming 0.68 Mpa fulfilling the standard requirement. For CBPB's made of treated particles, IBS increased by 54.67% for (P-B-SS-5), 37.29 % for(P-DS-SS-5), and 71.18 % in case of (P-DA-SS-5). Using 5 % of SS boards made of particles treated with borax and DSHP77g/l fulfilled the standard requirement, while DAHP 150 stands out of standard Fig.4.14.

For boards made of poplar particles with 0.2 % of (PDDA+MM), the untreated board did not meet the standard requirement with IBS= 0.28 Mpa. Fire retardant's pre-treatments decreased IBS of the CBPB's for (P-B-PM-0.2) reduced by 12 % for (P-DS-PM-0.2) decreased by 64.28 %. IBS decreased by 21.42 % in the case of (P-DA-PM-0.2). By increasing the (PDDA+MM) to 20 % control, specimens IBS increased by 54.84 %, IBS of (P-DS-PM-20) increased by 82.47 %, and IBS of (P-DA-PM-20) increased by 67.65 %. Upgrading the boards to the standard requirements. However, for borax pre-treatment, even with 20 % of (PDDA+MM) board cured but have low IBS 0.45 Mpa see Fig.4.14.

An increase in the bond agent concentration leads to an increase in MOR at the same time increase in the CBPB's density. CBPB's made of particles pre-treated with borax has a low density with high MOR comparing with other CBPB's in case of using SS as a bond agent. For thickness, swelling increasing the concentration of bond agents reduces the TS of the boards. Best results

achieved by CBPB made with particles pre-treated with DAHP 150 g/l on which TS reduced by 85.56 % by using SS as a bond agent and 88.69 % by using PDDA+MM see Fig.4.14.

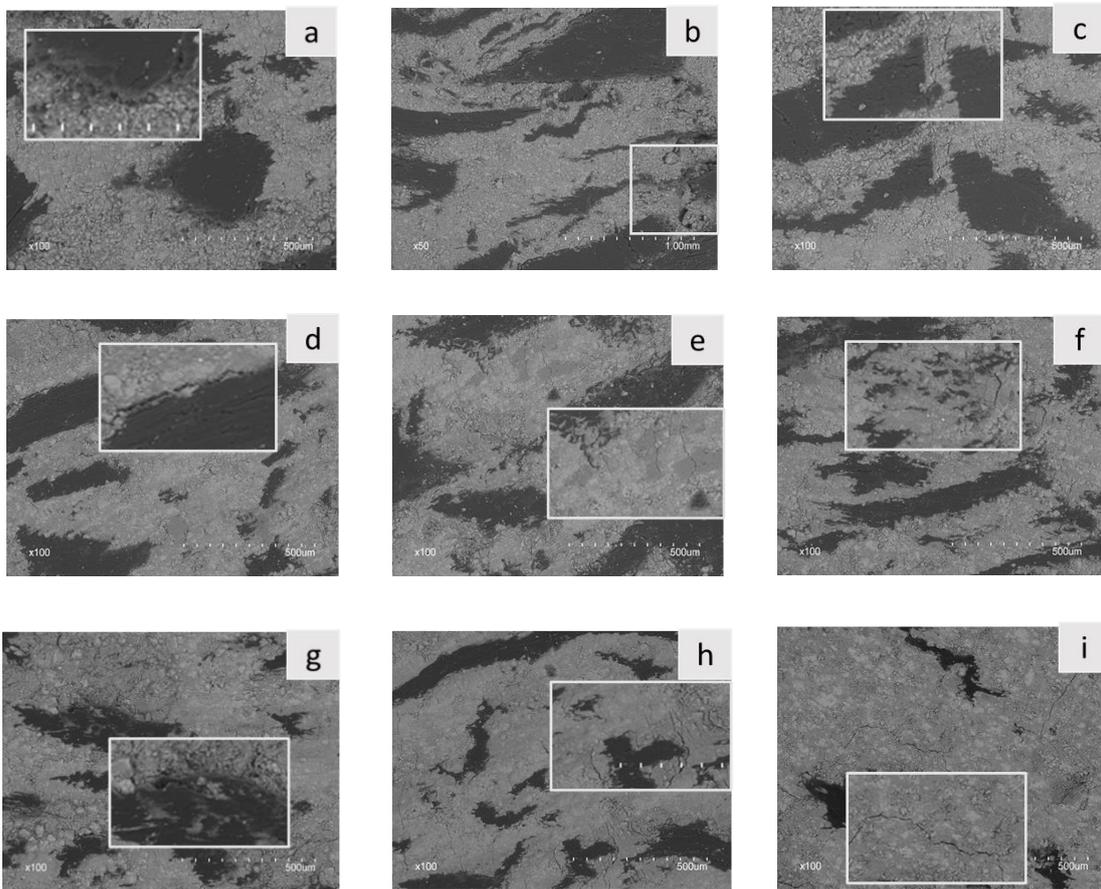


**Figure 4. 14:** IBS (MPa) and TS (%) of CBPB (a) CBPB made of Scots pine with SS as additive, (b) CBPB made of Scots pine with PDDA+ MM additive as additive, (c) CBPB made of poplar with as additive SS , (d) CBPB made of poplar with PDDA+ MM additive as additive.

#### 4.2.2.1.3 Scanning electron microscopy (SEM) evaluation

The specimens with a high amount of additives were subjected to SEM analysis to compare and determine the microstructure of the CBPB's (matrix and wood particle bonding). The results of the analysis shown in Fig.4.15. Dark grey represents wood light grey represents the cement matrix. Most specimens show a bond between CBPB's materials (cement and wood particles) indication of high adhesive force. Only board Sc-N-SS-5 in image (a), P-B-PM-20 in image (g), and board Sc-DA-SS-5 in the image (d) did not show good bonding among the cement matrix and wood particles.

These results are compatible with the mechanical properties results where these last-mentioned boards have both low MOR and IBS test results. Board P-DA-SS-5 shows good bonding of cement matrix and cement (Fig.4.15 (h)). These results are proper with the high IBS and low MOR than the standard. In most of the images of the specimens, dot-like spots appear that are results of unsmooth finishes caused by bad matt formation. The concentration of cement wood mixture at some regions in (Fig.4.15. (b)) indicates uneven mixing of the composite ingredients that decrease the intermediate characteristics of the specimen in those regions. The cracks that appear in images (Fig.4.15 (c, d, e, f, h, i)) indicate the fast drying of cement wood mixture. Most of the boards that have cracks contain DAHP 150 g/l pre-treated wood particles. That could have occurred because shortage of the mixing water during the hydration process.



**Figure 4. 15:** SEM images for CBPB's. (a) CBPB Sc-N-SS-5. (b) CBPB Sc-N-PM-20. (c) CBPB Sc-B-SS-5. (d) CBPB Sc-DA-SS-5. (e) CBPB Sc-DA-PM-20. (f) CBPB P-N-PM-20. (g) CBPB P-B-PM-20. (h) CBPB P-DA-SS-5. (i) CBPB P-DA-PM-20.

#### 4.2.2.2 Experimental analysis for hygroscopic and mechanical properties:

The difficulty of choosing the right type of analysis derives from the fact that the two different additives used where each one applied with two different amounts. The lower and higher amount levels may not mean the same level of influence on the bonding process in the case of the two types of additives. In other words, it's better to speak of four amount levels where two of them only occur with the first additive and the other two with the second additive. In a sense, it also means that the levels (lower and higher) of amount as a categorical (also called nominal) variable are nested under the additive types.

On the basis of the literature of Nested ANOVA, in our case additive types form a group and the four amount levels form two sub-groups. In theory and in the examples in the literature the sub-groups are random samples of a larger set of possible subgroups, whereas in this case a sub-group (a lower and higher amount value of an additive) is fixed. Despite this fact it seems expedient using Nested ANOVA as one type of analysis because of the nested occurrence of amount levels. As a complementary analysis I also conducted normal Main Effect ANOVA (MANOVA) by using only two, namely low and high levels of the variable "Amount" regardless of the type of additives. Regarding the six repeatedly taken test pieces for each type of test, they have been cut out from the test panel in a way that their position within the panel was not exactly the same in all cases. Therefore, it may assume random sampling to allow the pre-treatment of the individual measurements as genuine repetitions in order to have higher degrees of freedom, hence higher power of the statistical tests. Since the interaction between the factors like pre-treatments and additives may have influencing effect on the results, a full factorial ANOVA was conducted with main factors and interaction effects as follows: (A) pre-treatment, (B) additive, (C) amount, (AB) interaction between pre-treatment and additive, (AC) interaction between pre-treatment and amount, (BC) interaction between additive and amount and (ABC) interaction between pre-treatment, additive and amount.

Based on the results of the analyses, it can be concluded that the physical and mechanical properties of the fire-retardant treated cement-bonded particleboards are significantly influenced by the type of additive and kind of pre-treatment in the case of both the Scots pine based and poplar-based panels, with the exception of the thickness swelling of the panels made from Scots pine particles, see Table IV.1, Table IV.2 and Table IV.3. However, since amount levels applied with the two kinds of additives are different, the use of nested ANOVA model explores further details even in this latter case. Assumptions of the validity of ANOVA were often not met: either

the homogeneity of variances or the normal distribution of residuals is violated, see Table V.4, Table IV.5 and Table IV.6 for homogeneity of variances and Figure IV.6- Figure IV.29) for the normal distribution of residuals. Therefore, in most cases the Newman-Kleus test of significance was used for pairwise comparison, as suggested by textbooks on Statistics [156].

#### 4.2.2.3 Detailed statistical inferences:

##### *MOR, Scots pine based panels*

Fire retardant pre-treatments with the exception of DSHP 77 g/l have significant effect on MOR of CBPB's. Both borax and DAHP 150g/l decreased the MOR but in case of borax high amount of SS helped fulfilling the standard requirement. Using PDDA+MM with either concentration, the boards did not fulfil the requirement; on the contrary, DAHP with 20 % amount of PDDA+MM fulfil the standard (Table IV.7). The sizes of effect of DAHP 150 g/l with the two amounts differ significantly. The type of additive has significant effect on MOR (Table IV.8), so does the amount of the agent (Table.9). Nested ANOVA reveals that this is only true on the lower level of additive amount, while the level of amount is important with both additives (Table IV.9). The factorial ANOVA supported both the results of Main and Nested ANOVA. Additives and their amounts have different effect at each pre-treatment, based on the Factorial ANOVA results for control specimens' MOR; there is a significant effect of additive and its amounts except for PDDA+MM with high used and SS with low amount which proves SS more effective on untreated CBPB with amount lower than 5 %, while PDDA+MM is shown more effective at higher amount. For borax pre-treated CBPB both types of additive and their amount has significant effect on CBPB; the same is true for DAHP 150 g/l. Pre-treatment with DSHP 77 g/l shows a significant effect of additive and its used amount but there was no difference between high amounts of SS and PDDA+MM (Table IV.34).

##### *Density, Scots pine based panels*

Among fire retardants, only borax has significant effect on the density of panels, and its effect is significantly different from those of the other retardants. Nevertheless, Factorial ANOVA indicated that DAHP 150 g/l has significant effect as well and the difference between it and borax is significant (Table IV.10). Both the type of additive and their used amount have significant effect on density (Table IV.11 and Table IV.12). Nested ANOVA reveals that this is only true on the lower level of used amount. Level of the amount applied is only important in the case of

PDDA+MM (Table IV.12). Factorial ANOVA for control samples show no significant difference between additives and its used amounts except between low amount of SS and high amount of PDDA+MM. In other hand, Borax have significant difference among additives and their used amounts except between high amount of PDDA+MM and low amount of SS. Specimens pre-treated CBPB with DAHP 150 g/l indicates significant difference in the density because of additives and their used amounts. Nevertheless, high amount of PDDA+MM shows no significant difference with either amount of SS. For DSHP 77 g/l, results were as follow: no significant difference in density between SS amounts while a significant effect occurs between PDDA+MM amounts. A significant difference in density is shown at low amounts of SS and PDDA+MM while no significant effect of the type of additive is verified at the high amounts (Table IV.38).

#### *IBS, Scots pine based panels*

The type of the applied fire-retardant has no significant effect on the IBS of panels with Main and Nested ANOVA while Factorial ANOVA indicated that fire retardants have effect on the IBS of the CBPB's except for DSHP 77 g/l. Borax improved IBS with SS while decreased it with PDDA+MM in other hand DAHP 150 g/l decreased IBS with SS and improve it with PDDA+MM (Table IV.13). For the type and amount of additive the same is true as in the case of density of the same kind of panels (Table IV.14 and Table IV.15). Factorial ANOVA show a significant difference in IBS of control and pre-treated CBPB's with fire retardants in additives and their amounts except with DSHP 77 g/l between high amount of additives (Table IV.42).

#### *Thickness swelling, Scots pine based panels*

Main and Nested ANOVA shown that the type of the applied fire-retardant has no significant effect on the TS of panels while Factorial ANOVA indicated that fire retardants have effect on the TS of the CBPB's except for DSHP 77g/l. Borax and DAHP 150 g/l increased the TS of the CBPB's with using SS as additive while increased the TS of the CBPB with PDDA+MM (Table IV.16). Statistical tests show significant effect of the type of additive applied, while there is no significant difference detected between the swelling values obtained with lower and higher amount of the additive (Table IV.17 and Table IV.18). At the same time, Nested ANOVA indicates significant difference due to the used amount level for both additives and no significant difference due to the type of additive at the higher used amount (Table IV.18). Factorial ANOVA revealed that there is significant difference in TS except between high additive amount of PDDA+MM and low additive amount of SS and among the low and high amounts of PDDA+MM as well for control specimens.

For borax the non-significance occurred only among the low and high amount of SS. In other hand, the non-significance effect of type of additives and their used amount for DSHP 77 g/l found only between low and high amount of PDDA+MM with low used amount of SS. Results of DAHP 150 g/l were as follow: no significant effect of used amount of both additives on the TS. There is significant difference between the low amount of additives on the TS while no significant difference between high used amounts of additives (Table IV. 46).

#### *MOR, Poplar based panels*

According to Main and Nested ANOVA fire retardants decreased significantly the MOR of CBPB's, Borax had significant higher MOR than of DSHP 77 g/l and DAHP 150 g/l in case of SS while the opposite in case of PDDA+MM. On the other hand, no significant different between DSHP 77 g/l and DAHP 150 g/l with both types of additives. Factorial ANOVA indicated that fire retardants had significant different between each other for SS it comes borax, DSHP 77 g/l than DAHP g/l while for PDDA+MM it comes DSHP 77 g/l, DAHP 150 g/l at last borax (Table IV.19). Both the type of additive and their used amount have significant effect on MOR (Table IV.20 and Table IV.21). Nested ANOVA reveals that this is only true on the lower level of amount (Table IV.21), the same for Factorial ANOVA (Table IV.50).

#### *Density, Poplar based panels*

The type of the applied fire-retardant has significant effect on the density of panels, all fire retardants decreased the density of CBPB with both SS and PDDA+MM (Table IV.22). Statistical tests show no significant effect of the type of additive applied, while there is significant difference detected between the density obtained with lower and higher amount of the additive (Table IV.23 and Table IV.24). At the same time, Nested ANOVA indicates significant difference due to the amount level for both additives and no significant difference due to the type of additive at the higher amount (Table IIV.24).

#### *IBS, Poplar based panels*

Main and Nested ANOVA showed that the type of the applied fire-retardant has significant effect on the IBS of panels while no significant difference appears between the fire retardants. However, Factorial ANOVA indicated that fire retardants are significantly different from each other. In case of SS, DSHP 77g/l and DAHP 150 g/l decreased the IBS while borax increased it.

Using PDDA+MM, borax and DSHP 150 g/l decreased the IBS while DAHP 150 g/l increased the same (Table IV.25). Nested ANOVA proved that both the type of additive and their amount have significant effect on IBS (Table IV.26 and Table IV.27). Factorial ANOVA indicated that for control samples and DSHP 77 g/l specimens both additive and amount have significant effect except for high amount of the additives when the type of additive becomes not effective. For borax and DAHP 150 g/l both additive and amount have significant effect on the IBS of the CBPB (Table IV.58).

### *TS, Poplar based panels*

Fire retardant pre-treatments with the exception of DSHP 77 g/l have significant effect on TS of CBPB's. Borax and DAHP 150g/l decreased TS of the boards with both additives (Table IV.28). The type of additive has significant effect on TS, so does the amount of the agent (Table IV.29 and Table IV.30). Nested ANOVA reveals that this is only true on the lower level of amount, while the level of amount is important with both additives (Table IV.30). Factorial ANOVA indicated that the level of amount of PDDA+MM is indeed significantly effective on the TS while the amount of SS has no significant effect on control specimens. There is a significant difference between the board properties at the low levels of the two additives while no significant difference shows up applying them at their high levels. Using borax, no significant difference appeared due to either the type or the amount of the. The amount of additive with pre-treatments of DAHP 150 g/l and DSHP 77 g/l is significant using PDDA+MM while not significant when using SS. The effect of the type of additives was found significant for DAHP 150 g/l on the low level of amount. significant (Table IV.62)

On the basis of the identified significant differences, we could derive statements about the decrease in mechanical properties and increase in physical properties of the pre-treated CBPB's due to fire retardant pre-treatments. Most benefits of pre-treatments on mechanical and physical properties were achieved in the case of poplar. SS is a good additive at the lower amount (2 %) for untreated CBPB-s with Scot's pine while the opposite is true for poplar-based boards. On the other hand, it is advantageous in enhancing mechanical properties at its higher amount of 5 % for pre-treatments with Borax and DSHP 77 g/l while having negative effect with DAHP 150 g/l at both amounts. PDDA+MM at its higher amount (20 %) has a positive influence on the mechanical properties of the CBPB-s treated with DSHP 77g/l and DAHP 150 g/l on while negatively

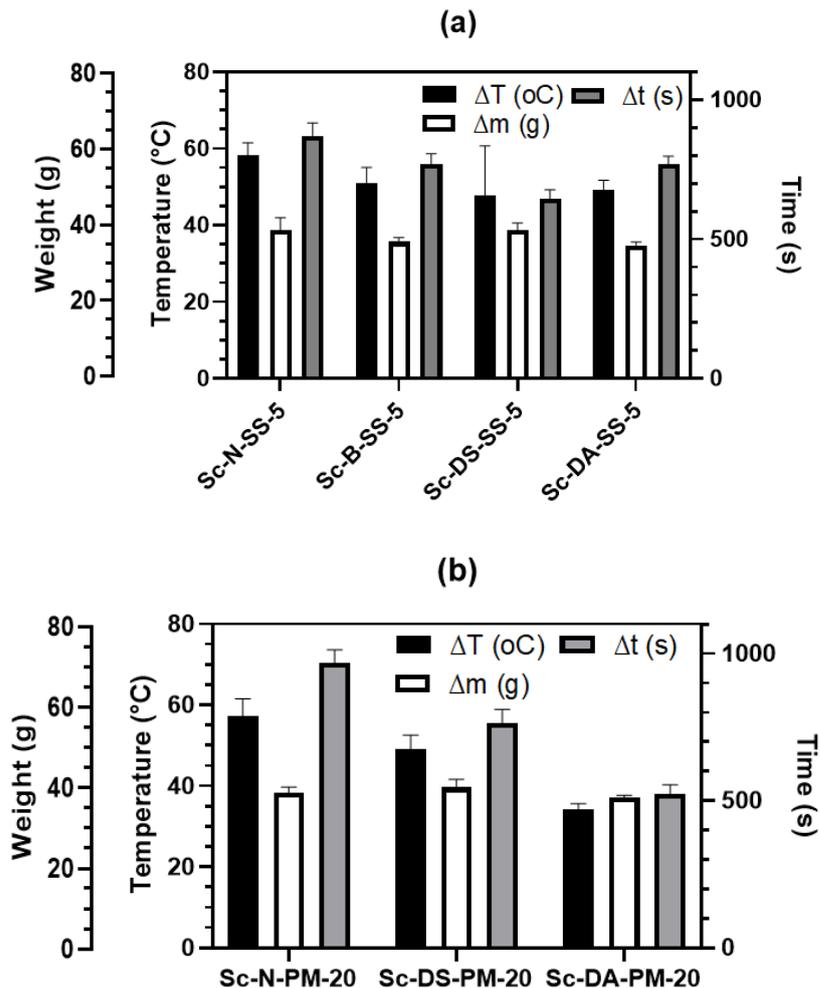
influences the performances of the Borax pre-treated CBPB-s. DAHP 150 g/l with both additives at their high amount and Borax with PDDA+MM at 20 % amount decrease the TS to nearly 0.5 % in the case of poplar.

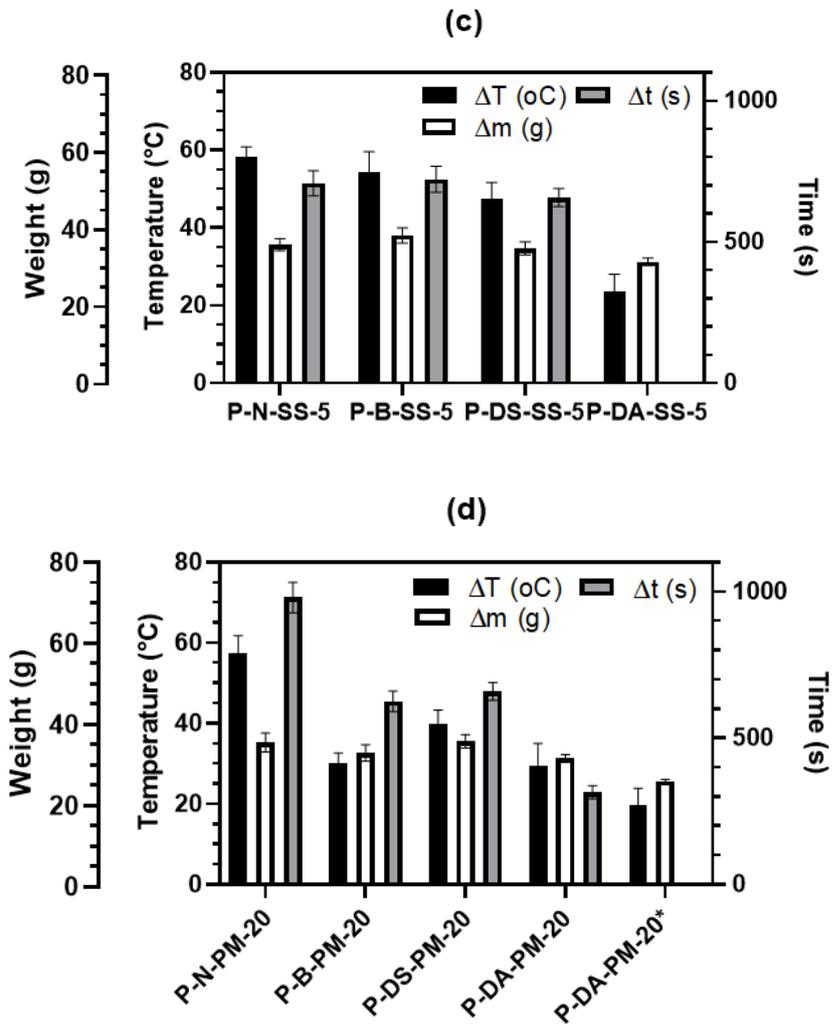
**4.2.3 Flammability properties:**

**4.2.3.1 Standard requirements fulfilment for fire classification:**

**4.2.3.1.1 Non combustibility test:**

Incombustibility test see Figure 4.16, indicated that fire retardants has better performance on poplar than of Scots pine as it was expected when it was tested on solid wood [137]. Fire retardant pre-treatments had no big effect on fire performance of CBPB’s made of Scots pine except for DSHP 150 g/l, which reduced the  $\Delta T$  with 40.03 % in case of CBPB by (PDDA+MM) additives with  $\Delta T =$  to 34.32 °C (Table 3) and  $\Delta m = 37.06$  g both these results are with in standard classification A<sub>2</sub> [9], however, the flaming time  $\Delta t$  is bigger than the standard requirement which is 20 s of flaming. Mass loss of CBPB was lower than 50 % in all cases.





**Figure 4. 16:**  $\Delta T$  ( $^{\circ}$ ),  $\Delta m$  (g) and  $\Delta t$  (s) of non-combustibility test for CBPB made of Scots pine.

**Note:** \* samples soaked into SS let to dry 7 days before test

For CBPB’s made of poplar, fire retardants have an influence on fire performance. The  $\Delta T$  of CBPB made of DAHP150g/l pre-treated particles and SS was reduced by 59.53 % with  $\Delta T=23.52$   $^{\circ}C$ ,  $\Delta m=34.54$  % which is lower than 50 % of mass loss and no flaming upgrading the board to A<sub>1</sub> class according to EN ISO 13501-1:2007 +A1:2010 classification [9]. CBPB’s made of borax and DAHP150 g/l pre-treated poplar particles with (PDDA+MM) additives increased  $\Delta T$  with almost 48% but there was flaming during the test and was more than 20 s which did not fulfilled the standard. Since the interaction between SS and DAHP 150 g/l prevent the flaming. Specimens with CBPB made of 150 g/l pre-treatment and (PDDA+MM) additives was soaked into SS and let to dry for one week before test. After testing, it was found that  $\Delta T$  was reduced by 65.78 % and there was no flaming, which upgrade the CBPB to A<sub>1</sub> class. SS is well known as a wood fire retardants [68], [83]. CBPB made of borax and DSHP 77 g/l with PDDA+MM had  $\Delta T$  and

$\Delta m$  with in the classification  $A_2$  but the flaming time was higher than the classification requirement.

**4.2.3.1.2 Single flame source test:**

For result of single flame source test. On surface (Figure 4.17), board P-B-PM-20 has no burn make at all while boards: P-B-SS-5, SC-DS-SS-5 ,P-DS-PM-20 and SC-DA-SS-5 have very transparent burn mark. However, shady burn marks are shown with boards, SC-N-SS-5, SC-N-PM-20, P-N-SS-5, P-N-PM-20, SC-B-SS-5, SC-DS-PM-20.



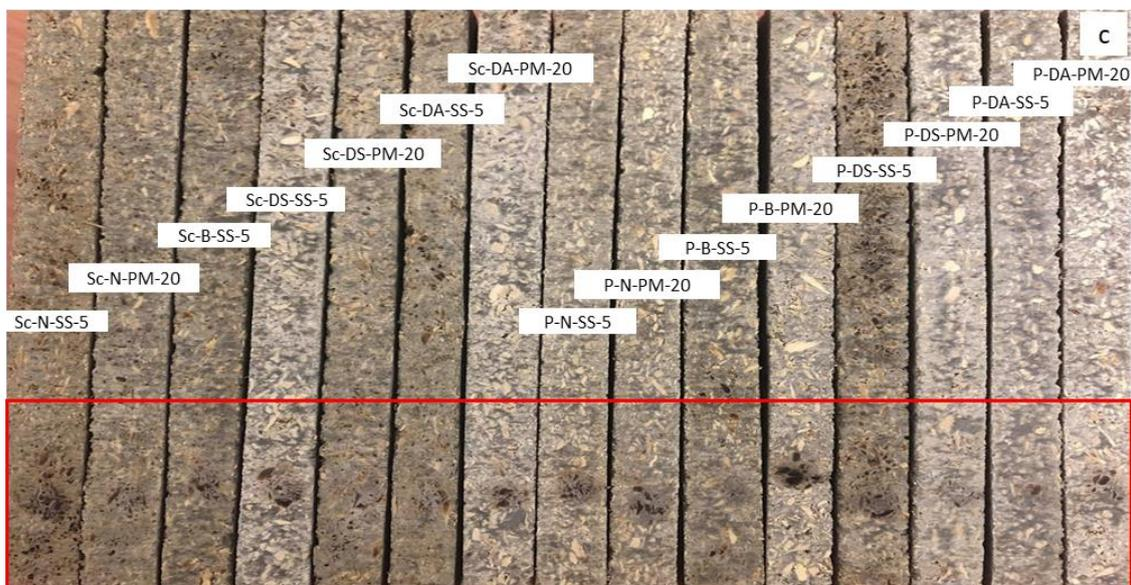
**Figure 4. 17:** Flame spread of CBPB made of poplar and Scots pine. Flame spread on surface of specimens.



**Figure 4. 18:** Flame spread of CBPB made of poplar and Scots pine. Flame spread on edge of specimens (left) Scots pine, (right) poplar.

On edge, there were no clear difference between all specimens, all has burn mark lower than 3 mm except for SC-DS-PM-20 which has smaller burn mark. On side, boards, P-B-SS-5, SC-DS-PM-20, P-DS-PM-20 and SC-DA-SS-5 has almost no flame burn while boards SC-N-PM-20, SC-B-SS-5, P-DA-SS-5 and P-DA-PM-20 has clearer burn marks and boards SC-N-SS-5, P-N-SS-5, P-N-PM-20, P-B-PM-20, SC-DS-SS-5, P-DS-SS-5, SC-DA-PM-20 has darker burn marks.

All CBPB-s were found non-flammable; there were no flame spread either on surface and edge or on side of the CBPB-s, see (Fig.4.17, Fig.4.18, Fig.4.19). Only superficial alteration appeared with different grades. In general, CBPB is considered as non-combustible material. Based on previous literature [79], [157], it is expected to have good results with such tests. Most of CBPB made of flame retardants has better results than the control ones. The single flame source test is good to test flame spread on material. Best results were achieved with borax on poplar with both additives with boards P-B-SS-5 and P-B-PM-20. Bysal [95] indicated in his research that borax is good flame suppresser and based on the pre-tests on solid wood [158] and the current results on CBPB, borax proved again that it is not just good flame suppresser for wood only but for wood based composites as well. Between the wood species poplar-based panels has better results than of Scots pine-based panels. DSHP 77 g/l and DAHP 150 g/l has good flame supressing with both scots pine and poplar.



**Figure 4. 19:** Flame spread of CBPB made of poplar and Scots pine. Flame spread on the side of specimens for poplar and scots pine CBPB.

#### 4.2.3.2 Non combustibility test statistical analysis

The aim of the experiments is to find out which of the board composition (characterised by bonding agent and fire retardant) gives the best result, i.e. lowest  $\Delta T$  value. This would require to consider only one independent variable (the given bonding agent and retardant) occurring in eight combination for SS and seven valid combination for PDDA+MM. That results 15 cases of the single variable. One-way ANOVA can be used to find the lowest  $\Delta T$  value that differs significantly from at least one another case. Fischer LSD test, Scheffe test and Newman-Keuls test are useful to perform, beside the usual test of homogeneity, probability plot and residuals tests. To find out which of the retardants with which additive yield better results and what is the effect of agents and fire retardants on  $\Delta T$  Main and full factorial ANOVA were used, two independent variables for the 15 cases, additive type (2 levels), and retardant (4 levels).

Since additives were applied in one of the amounts for fire tests, panel types were identified as panels with given additive and pre-treatment and One-way ANOVA was applied first to be able to make pairwise comparisons within the samples belonging to a particular additive.

The results of fire test obtained by panel type proved to be significantly different for both species of wood (Table IV.63). In the case of Scots pine-based panels the normality of the distribution of residuals was found violated (see Figure IV.30 and Figure IV.31), likewise the homogeneity of variances could not be verified (Table IV.64). In the case of poplar-based panels the prerequisites of the validity of ANOVA results were confirmed (Table IV.64). Therefore, for pairwise comparison of samples Scheffé test of significance was taken valid with regards to the relatively high number of comparisons (see Table IV.69), while in the case of Scots pine the results of Newman-Keuls test were kept as basis of conclusions (Table IV.67).

In accordance with the above considerations, it could be established that all board types made of Scots pine yielded fire test results that are significantly different of the results obtained for board type made with SS as additive and had not undergone fire retardant pre-treatment. However, no other pairwise comparison proved to be significant, that is neither the type of additive nor the kind of pre-treatment resulted in statistically verifiable differences, with the exception of untreated boards made with the two different additives (Table IV.66 and Table IV.67)).

By contrast, Scheffe test of samples from poplar-based panels (Table IV.69) suggests that the kind of additive has significant effect of the performance showed in fire test only in the case of using borax as fire retardant. Staying with the same additive, pre-treatment with DS 77 g/l and

DA 150 g/l changed the panel performance significantly while results of pre-treatment with DS 77 g/l and DA 150 g/l were found significantly different of each other in the case of using water glass additive. Panels made with PDDA+MM showed significantly improved performance with all three types of fire-retardant pre-treatments while no significant difference could be verified between pre-treatments.

Main effect ANOVA showed the factor effects significant for panels made of both species of wood (Table IV.71). Homogeneity of variances was found violated for the kind of pre-treatment while verifiable for the kind of additive in case of both wood species. Distribution of residuals could be accepted as normal in the case of poplar (Figure IV.27 and Figure IV.29). Therefore, with the exception of the effect of additive in the case of poplar, Newman-Keuls test of significance should be used (Table IV.80).

Pairwise comparison of the results of pre-treatment of Scots pine-based panels implies that the effect of the two pre-treatments, e.i. the use of DSHP 77g/l and DAHP 150 g/l are significant, but the difference between the two is not significant. In the case of poplar-based panels all the three pre-treatments have significant effect. The results obtained by the use of DAHP 150 g/l are significantly different of those by borax and DSHP 77 g/l.

The effect of additives in the case of Scots pine was found significant, showing the use of PDDA+MM superior to SS (Table IV.76) The effect of additives in the case of poplar as evaluated by Fisher LSD test indicated that a significant difference appears because of additives for all pre-treatments PDDA+ MM has better results than of SS.

Factorial ANOVA supported the results of main ANOVA the factor effect significant for panels made of both species of wood (Table IV.72). The same for homogeneity of variances it was found violated for the kind of pre-treatment while verifiable for the kind of additive in case of both wood species (Table IV. 74). Distribution of residuals could be accepted as normal in the case of poplar (Figure IV.30). Homogeneity of variances found violated for the interaction for Scots pine while verifiable for poplar (Table IV.74) there for LSD fisher test of significance should be used.

Pairwise comparison within Factorial ANOVA showed the same results as MAIN ANOVA. For factors interaction in case of scots pine there are no significant different in the interaction between pre-treatments and additives except for DAHP 150 g/l with PDDA+MM (Table IV.77). The interaction of DAHP 150 g/l with PDDA+MM has superior effect than with SS. For poplar

all interactions between pre-treatment and additives are significant different except for Borax with SS. There are significant different between interaction of additive with pre-treatment PDDA+MM has better results than of SS in all pre-treatments (Table IV.80).

As conclusion, fire retardants have no significant effect on the fire resistance of scots pine based CBPB except for DAHP 150 g/l with PDDA+MM while has a significant effect on poplar based CBPB. The used additive shown significant effect in both cases scots pine and poplar based CBPB. The interaction of pre-treatment and additive not significant in case of scots pine while significant in case of poplar based CBPB. Interaction of pre-treatments with PDDA+MM has better effect on fire resistance of the CBPB than of SS. In the end, results appeared as expected: the pre-tested fire retardants perform better on poplar than of Scots pine [137], [158]. Finally, it could be stated that DAHP 150 g/l has advantage in enhancing the fire classification of poplar based CBPB to A<sub>1</sub> with SS as an additive with 5 % amount or with PDDA+MM with 20 % amount and SS coating.

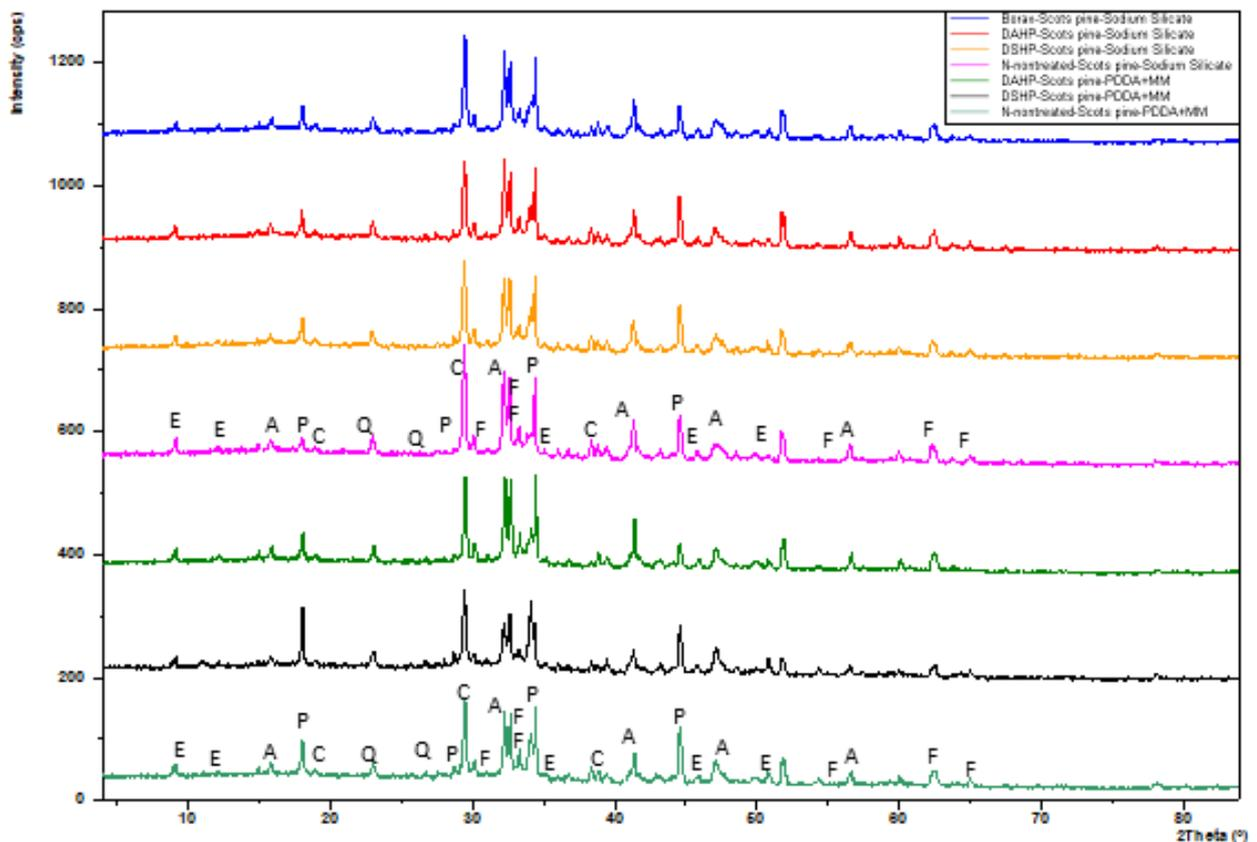
#### **4.2.4 Comparison of the thermal and mechanical characteristics of the produced CBPB's and the effect of fire retardants pre-treatment on the cement wood mixture curing**

##### **4.2.4.1 X-Ray Diffraction (XRD) and Scanning Electron Microscopy (SEM)**

After 28 days of cement curing X-ray diffraction test was made to identify the phases in the CBPB's and if any crystalline phases formed because of the fire retardants. SEM images were taken at high magnification x.5k to identify the crystalline phases found by the XRD.

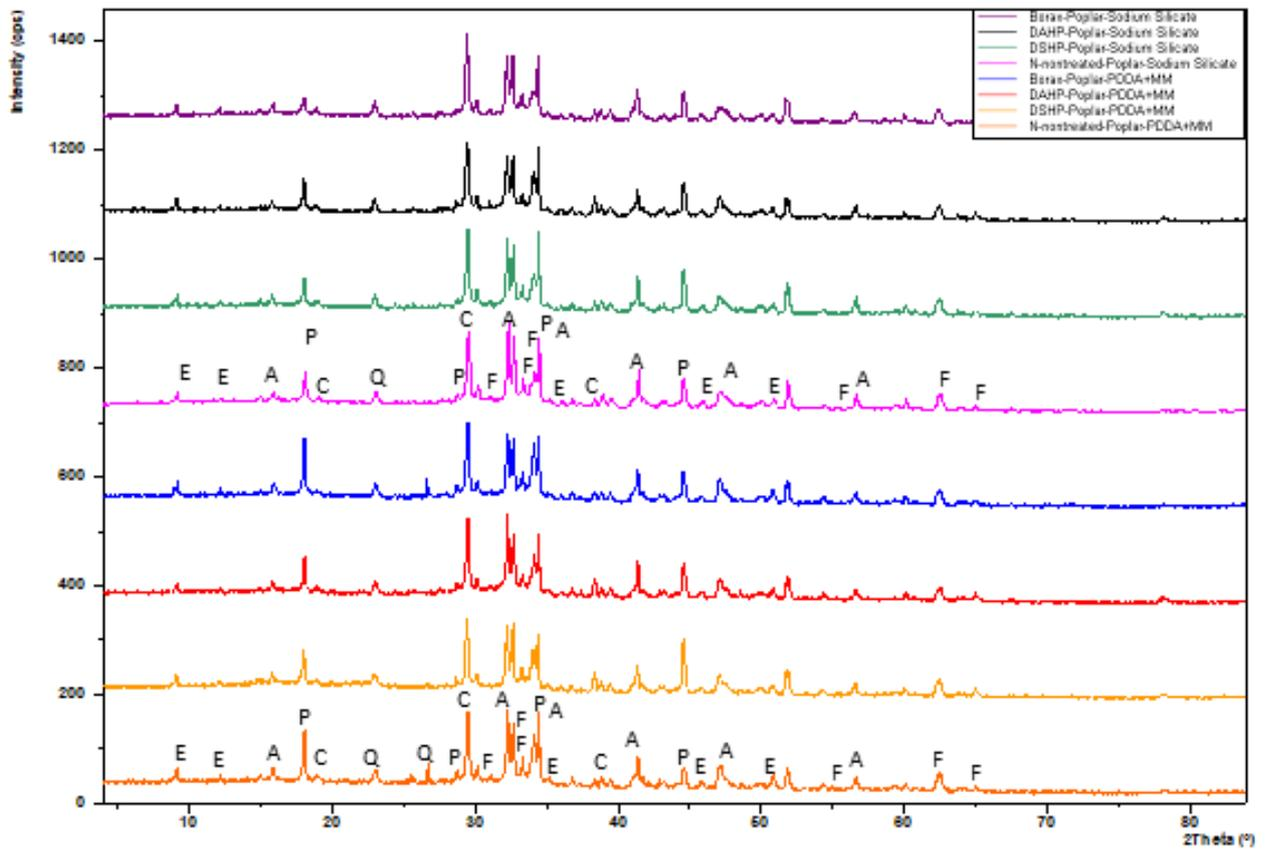
XRD results shown in Fig.4.20 for Scots pine CBPB's and Fig.4.21 for poplar CBPB's indicates that only typical phases in the cement matrix found, that are alite, portlandite, calcite, ettringite, ferrite, and quartz. SEM images represented in Fig.4.22 support the XRD pattern results. Most of the found phases that appeared in the SEM image analysis are the portlandite and the hydrated calcium silicate.

Three peaks belong to the same crystalline phase must rise to consider it as a new crystalline phase. According to the XRD patterns for both Scots pine and poplar-based-panels, only one unidentified peak rises that proves that no new crystalline phases formed during the reaction of cement mixture with fire retardants.

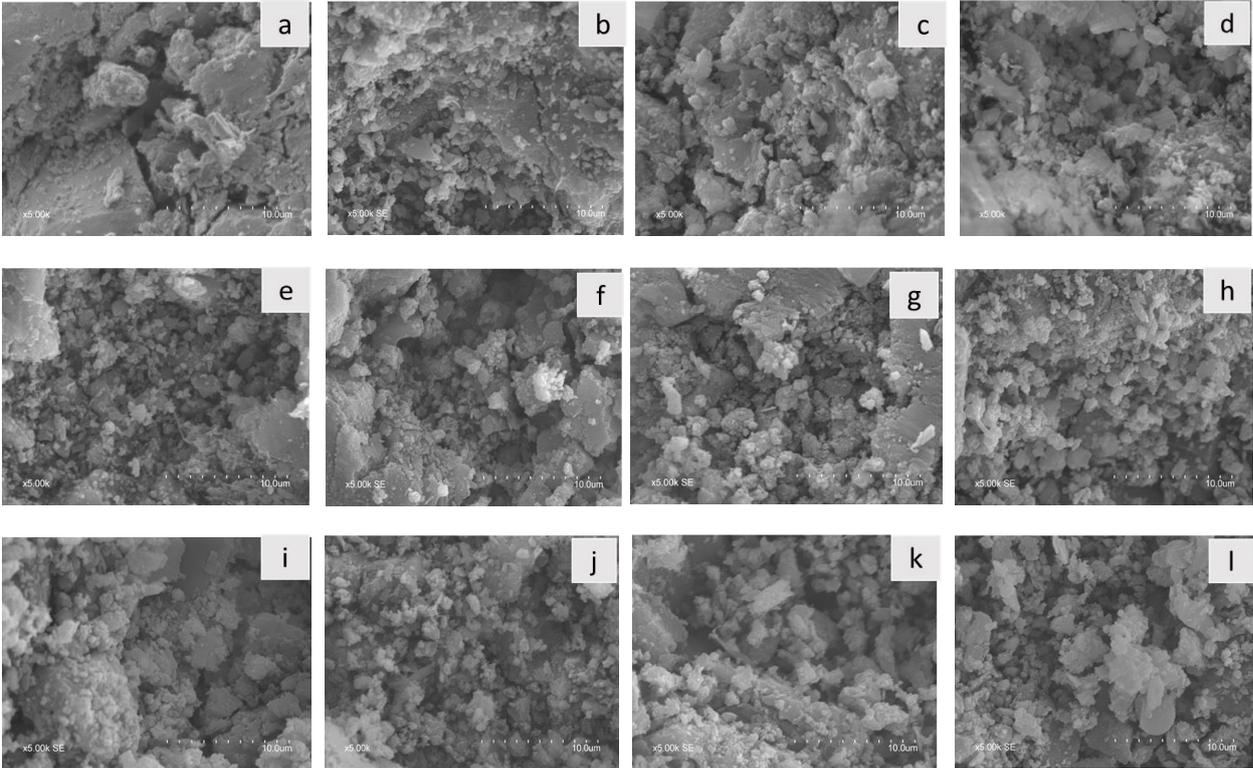


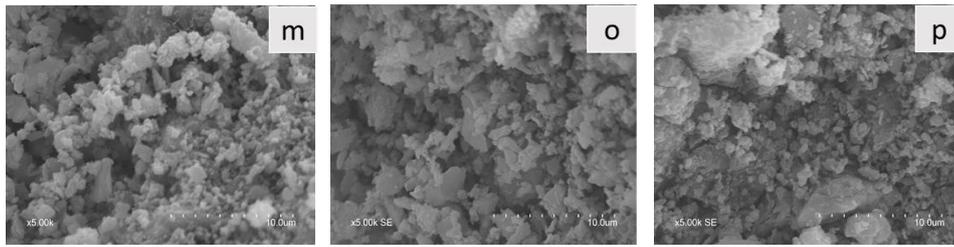
**Figure 4. 20:** XRD of CBPB's after 28 days of curing made of Scots pine with SS and PDDA+MM as additives. A: Alite, C: Calcite, E: Ettringite, F: Ferrite, P: Portlandite, Q: Quartz

In all XRD patterns, no changes appeared in most of the found cement phases, only slight increase and decrease in the calcium hydroxide and calcium carbonate found that connect to the physical and mechanical properties of the CBPB's. Making a TGA test can show a significant increase or decrease in the hydrates content. Overall, it concludes from XRD that there are no phases that appeared in the cement mixture because of fire retardants in the wood particles that means no new phase comes out and delay the hydration cement. The effect of the fire retardants on the mechanical properties of the CBPB's clearer now. According to a report in 2008 [165], when MC of the used wood particles is bigger than 30 % it effects the cement curing and as result drop the properties of the CBPB. It is better to have low MC in wood because during cement hydration in cement wood mixture, cement use both mixing water and water in wood particles, in total CBPB has to have approx. MC = 42 %. If wood particles have more than 30 % MC, most of the used water will be within the wood, during hydration process cement will start taking water from wood but inhibitors will come out with it, as a result effecting cement curing. In this study, all pre-treated particles MC was more than 30 %.



**Figure 4. 21:** XRD of CBPB’s after 28 days curing made of poplar with SS and PDDA+MM as additives. A: Alite, C: Calcite, E: Ettringite, F: Ferrite, P: Portlandite, Q: Quartz

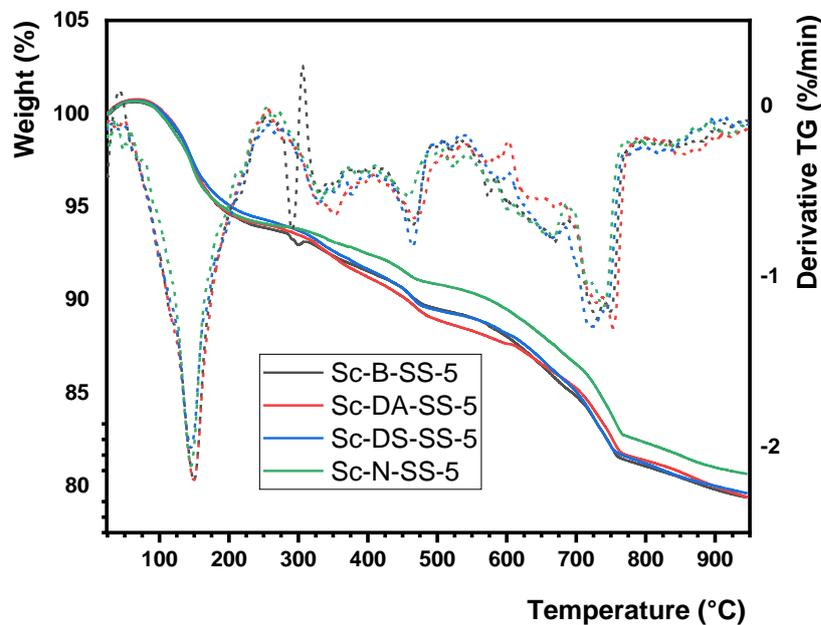




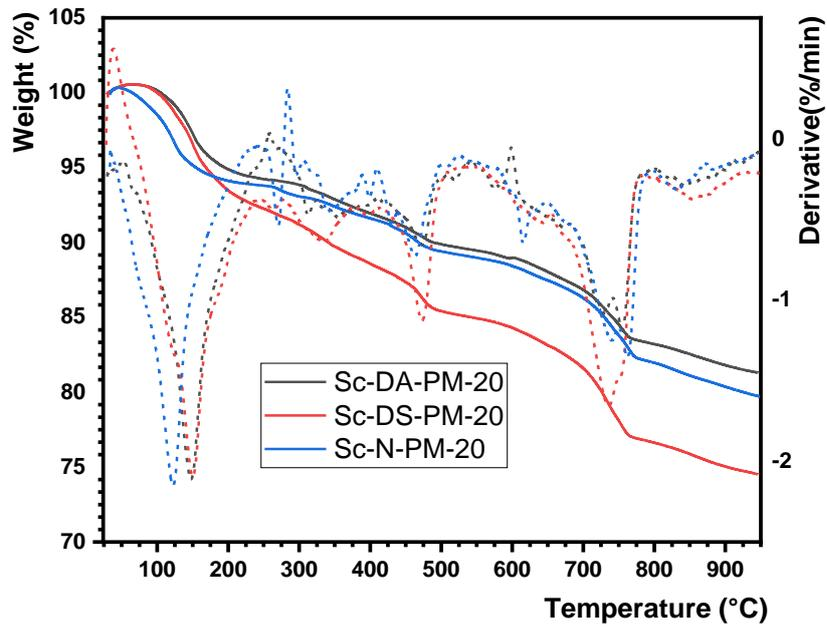
**Figure 4. 22:** SEM images for CBPB'S with (x5k). (a) CBPB Sc-N-SS-5. (b) CBPB Sc-N-PM-20. (c) CBPB Sc-B-SS-5. (d) CBPB Sc-DS-SS-5. (e) CBPB Sc-DS-PM-20. (f) CBPB Sc-DA-SS-5. (g) CBPB Sc-DA-PM-20. (h) CBPB P-N-SS-5. (i) CBPB P-N-PM-20. (j) CBPB P-B-SS-5. (k) CBPB P-B-PM-20. (l) CBPB P-DS-SS-5. (m) CBPB P-DS-PM-20. (o) CBPB P-DA-SS-5. (p) CBPB P-DA-PM-20.

#### 4.2.4.2 Thermal gravimetric analysis (TGA)

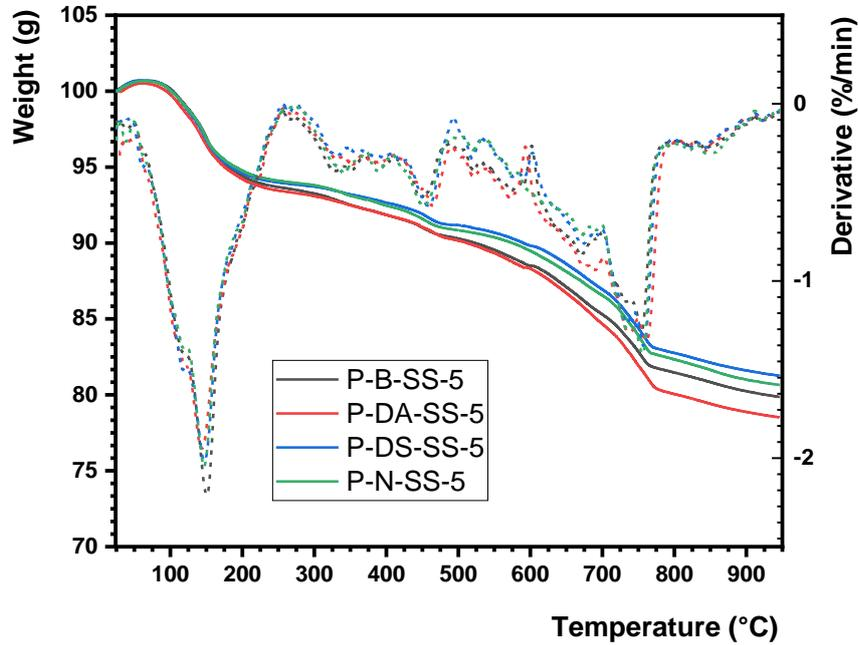
The thermogravimetric curve (TG) with straight line and its derivative (DTG) with dots line for control and pre-treated CBPB's after 28 days of curing (final curing) were presented in, Fig.4.23, Fig.4.24 represents results of Scots pine-based panels and Fig.4.25, Fig.4.26 represents results of poplar based panels. Based on DTG curves four peaks can be seen.



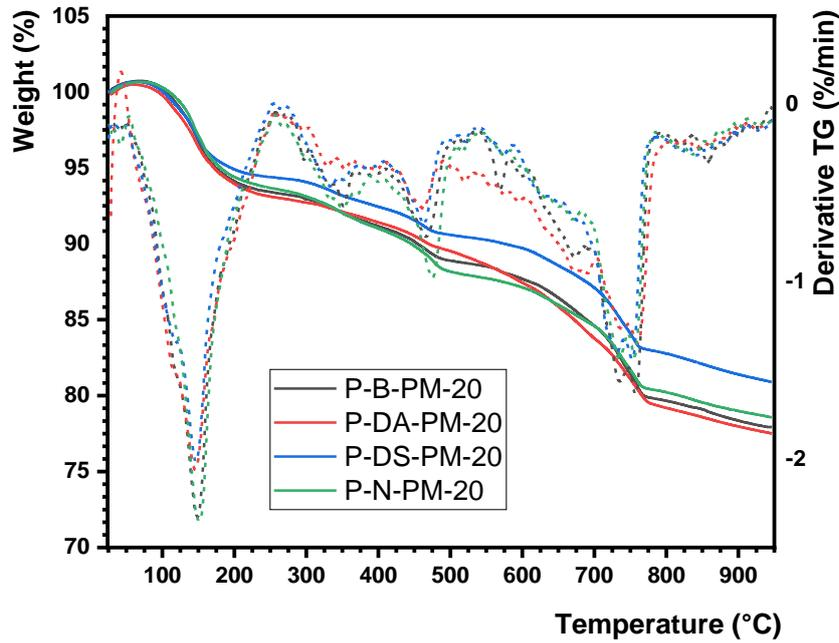
**Figure 4. 23:** TGA of CBPB after 28 day of curing (a) CBPB made of Scots pine and SS.



**Figure 4. 24:**TGA of CBPB after 28 day of curing CBPB made of Scots pine and PDDA+MM.



**Figure 4. 25:** TGA of CBPB after 28 day of curing CBPB made of poplar and SS.



**Figure 4. 26:** TGA of CBPB after 28 day of curing CBPB made of poplar and PDDA+MM.

The first peak from 38-260 °C represents the thermal decomposition of the hydrated calcium silicate (Alite) and ettringite. The second peak range between 260-385 °C is related to the decomposition of the scots pine and poplar particle components (cellulose decompose at temperature 180 to 350 °C while, lignin decomposes at 250 to 500 °C [159], [160]) in the cement powder and other hydrated compounds like ferrite. The decomposition of calcium hydroxide (portlandite) occurs in the third peak in temperature range 406-510 °C where it is proof that it was consumed by the formation of calcite. The last peak ranges from 545-800 °C caused by the decarbonization of crystallized calcium carbonate (calcite).

Portlandite is a product formed during the cement hydration process. However, calcite formed When the CO<sub>2</sub> from the air reacts with portlandite according to the following equation (Eq.4.1), the reaction result is called carbonation [159], [161].



The corresponding quantity of the weight loss of CBPB belongs to the four-peaks summarized in (Table 4.5) for four temperature ranges.

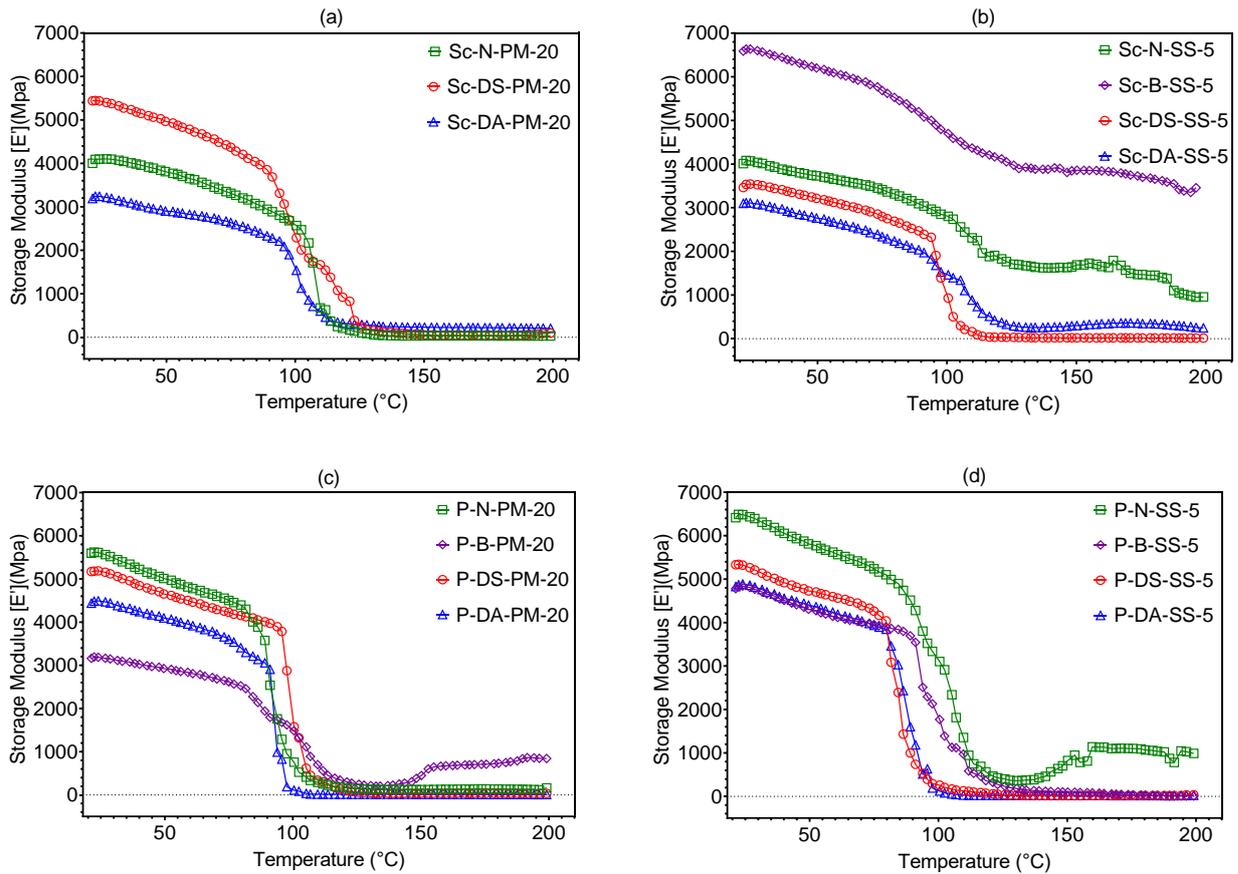
**Table 4. 5:** Weight loss (%) at the temperature ranges (°C) ((38-260), (260-385), (406-510), (545-800)).

CBPB	Weight loss (%) at the temperature ranges (°C)			
	25-250	280-495	495-600	600-900
Sc-N-SS-5	5.98	3.17	1.32	8.56
Sc-N-PM-20	6.19	3.81	1.04	8.15
Sc-B-SS-5	6.10	4.30	1.56	10.11
Sc-DS-SS-5	5.66	4.49	1.25	8.23
Sc-DS-PM-20	7.81	6.29	1.06	9.27
Sc-DA-SS-5	5.90	4.70	1.01	7.66
Sc-DA-PM-20	5.66	4.09	1.02	7.86
P-N-SS-5	5.94	3.21	1.36	8.47
P-N-PM-20	6.35	3.12	1.15	8.21
P-B-SS-5	6.29	3.17	1.64	8.42
P-B-PM-20	7.26	4.52	1.01	9.49
P-DS-SS-5	6.02	2.69	1.25	8.34
P-DS-PM-20	5.58	3.55	0.96	8.38
P-DA-SS-5	6.53	3.05	2.02	9.31
P-DA-PM-20	6.70	3.31	2.26	9.26

The smallest weight loss occurred on Scots pine-based panels at (406 °- 510 °C) and (545 °- 800 °C) were obtained from CBPB SC-DA-SS-5 and SC-N-SS-5 while the highest weight loss found on SC-B-SS-5. Weight loss causes due to the high amount of SS for SC-N-SS-5. That worked as a retarder of cement instead of the accelerator. In case SC-DA-SS-5, it could be caused by the DAHP 150 g/l that prolongs the cement curing preventing the production of portlandite and giving a low amount of calcium carbonate by reacting with CO<sub>2</sub> in the air. These results are suitable for mechanical properties. For poplar-based panels, P-N-PM-20 has the highest mass loss, P-B-PM-20, and P-DA-SS-5 have the lowest mass loss. The small weight loss in P-DA-SS-5 and P-B-PM-20 occurs because of the small amount of portlandite in the cement paste as a result of the cement inhibition during the hydration process caused by borax and DAHP 150 g/l. The mechanical properties support the TGA findings. The smallest mass loss in a temperature range of (260-385°C) on Scots pine found on SC-DA-PM-20 while on poplar P-DA-SS-5 and P-DA-PM-20, even boards P-B-PM-20 and P-DS-PM-20 have lower mass loss than control CBPB. The low

weight loss happens by the increase of fire resistance of CBPB by the used fire retardants [162]. The results come compatible with the non-combustibility test results where DAHP 150g/l has the best fire retardancy. Fire retardants are effective only on poplar except for DAHP 150 g/l that effective on both wood species-based panels with the use of PDDA+MM.

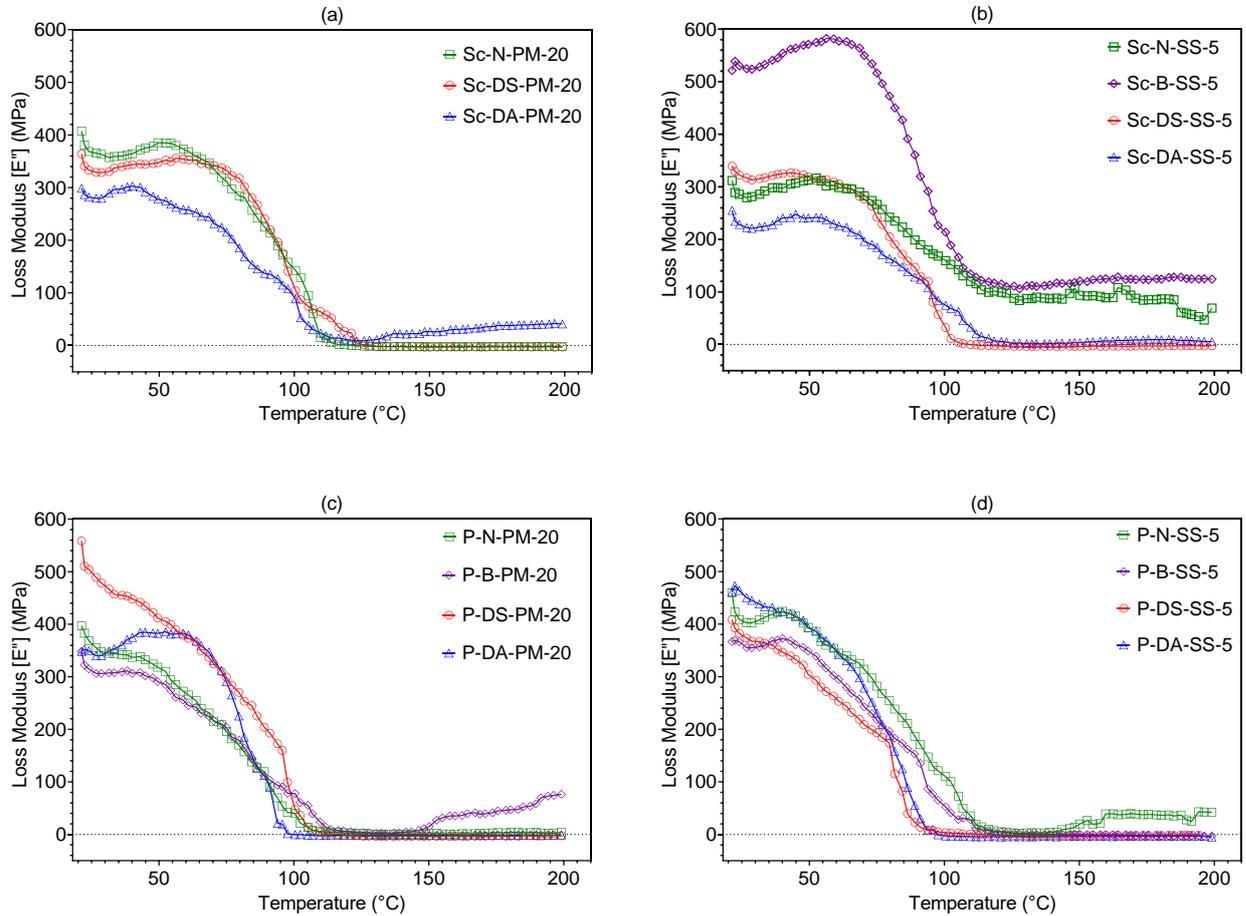
#### 4.2.4.3 Dynamic mechanical analysis (DMA)



**Figure 4. 27:** Storage Modulus of CBPB after 28 day of curing for DMA test (a) CBPB made of Scots pine and PDDA+MM. (b) CBPB made of Scots pine and SS. (c) CBPB made of poplar and PDDA+MM. (d) CBPB made of poplar and SS.

In this study, sinusoidal stress of 1Hz applied to the specimens, and the change in the strain evaluated. The results of bending storage modulus analysis represented in Fig.4.27.(a,b) for Scots pine based panels and Fig.4.27. (c,d) for poplar-based-panels and loss modulus  $E''$  represented in Fig. 5.12. It can observe that the highest  $E'$  in case of scots pine-based panels with PDDA+MM was achieved on SC-DS-PM-20 and lowest on SC-DA-PM-20 while with SS highest storage modulus found on SC-B-SS-5 and lowest SC-DA-SS-5 (see Fig.4.27.a,b). Results of poplar-based

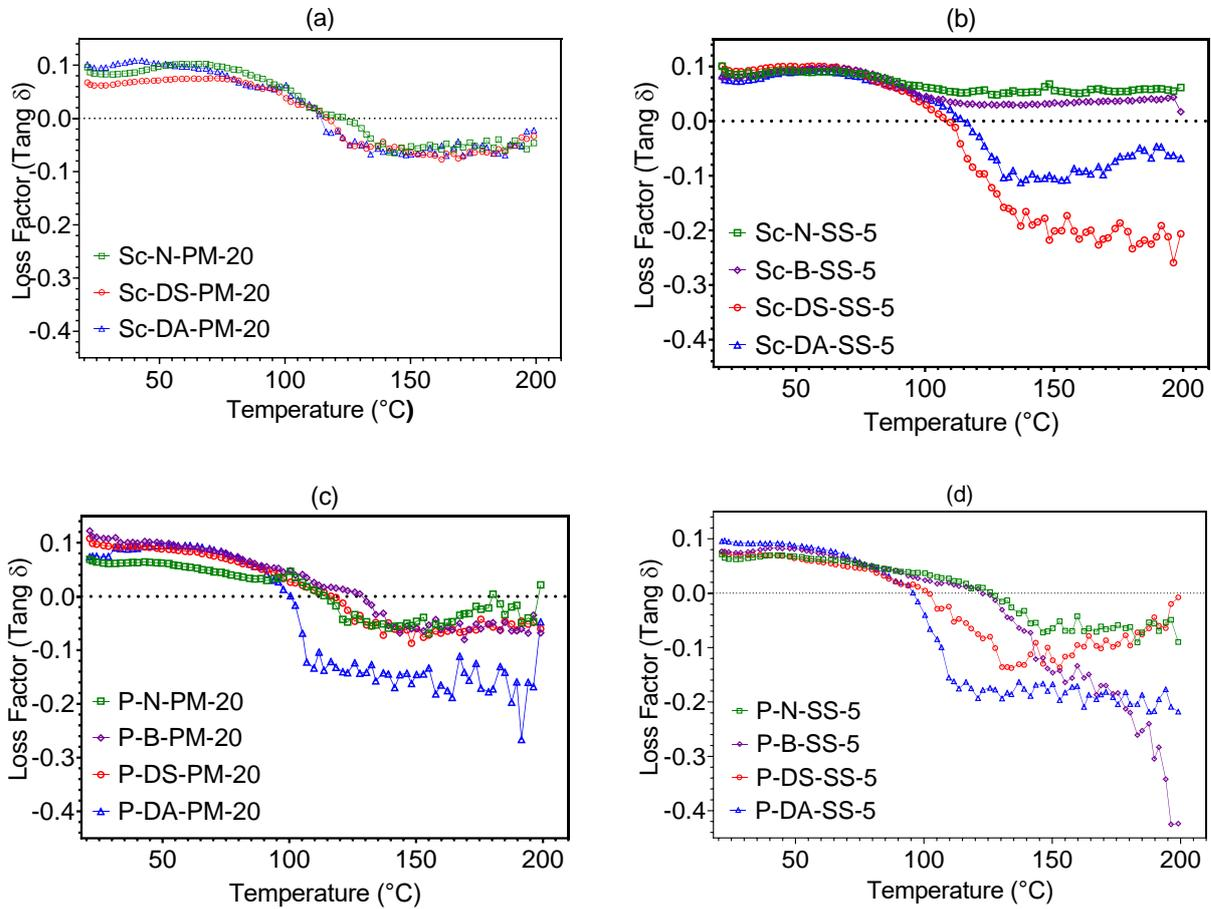
panels with PDDA+MM indicated that P-N-PM-20 has the highest storage modulus while P-B-PM-20 has the lowest, while SS P-N-SS-5 has the highest  $E'$  and B 30 the lowest.



**Figure 4. 28:** Loss Modulus of CBPB after 28 day of curing for DMA test (a) CBPB made of Scots pine and PDDA+MM. (b) CBPB made of Scots pine and SS. (c) CBPB made of poplar and PDDA+MM. (d) CBPB made of poplar and SS.

In general, higher  $E'$  is associated with higher MOR while lower  $E'$  associated with lower  $E'$ , the increase in both  $E'$  and MOR related to the high bonding between wood particles and cement mixture and the work of adhesion provided by the additives (SS and PDDA+MM) on the hydration procedure [164]. By comparing the storage modulus of CBPB's based on the wood particles species, poplar-based CBPB's has higher storage modulus than of Scots' pine based CBPB's which is compatible result with the previous measured mechanical properties where poplar-based panels found with higher properties than of scots pine-based panels. According to the results in Fig.4.27 the temperature has negative influence on the storage modulus of the

CBPB's especially at temperature higher than 85 °C, the increase in temperature decreases the  $E'$ . Loss modulus  $E''$  show a decrease with the increase if temperature but no peak occurred.



**Figure 4. 29:**Loss Factor of CBPB after 28 day of curing for DMA test (a) (a) CBPB made of Scots pine and PDDA+MM. (b) CBPB made of Scots pine and SS. (c) CBPB made of poplar and PDDA+MM. (d) CBPB made of poplar and SS.

According to Tan  $\delta$  results of CBPB's shown in Fig.4.29, the lowest  $E'$  in case of scots pine-based panels with PDDA+MM was found on SC-DS-PM-20 and highest on SC-DA-PM-20 while with SS results were almost similar (see Fig.4.27. a,b). Results of poplar-based panels with PDDA+MM showed that P-N-PM-20 have lowest storage modulus while P-B-PM-20 have the highest. In other hand, with SS P-N-SS-5 have the lowest  $E'$  and B 30 the highest. Usually, the smallest loss factor indicates higher damping capacity while the highest loss factor indicates low damping capacity of the material. Temperature has huge influence on the loss factor, from temperature range of 20 to 50  $^{\circ}$ C the loss factor of all specimens' increases which means lower damping capacity. Between temperature range of 50 to 85  $^{\circ}$ C the loss factor start decreases slightly and when temperature

surpass 85 °C the loss factor starts decreasing significantly. After 85 °C of temperature the loss factor of the specimens differs, in the colder temperature the control specimens have the lowest  $\tan \delta$  which means control samples have more damping capacity than fire retardants containing CBPB's. However, after 85 °C pre-treated fire retardant CBPB's have lower loss factor than the control specimens, Best results found on DAHP 150 g/l than DSHP 77 g/l and finally borax which is the same order of their fire retardancy, untreated CBPB have the highest  $\tan \delta$  at higher temperature among all specimens.

## CHAPTER VI

### Summary

This part of the study concentrated on borax, DAHP, DSHP, and PEG 400, which are all popular, low cost, and low toxicity fire retardants for wood. Fire retardants were tested in different amounts on varying surface roughness. Wettability tested on sanded, sawn, and planed poplar I214 solid wood surfaces in comparison with the wettability of Scots pine by contact angle measurement. It has found that poplar's wettability is worse than of Scots pine, contact angle values of poplar have been significantly higher, irrelevant from machining type relative to Scots pine. An increase in the amount of the FR has mostly no influence on the wettability of Scots pine while getting worst for poplar. Results also showed that a high amount of the FR resulted in significant differences in the contact angle values of sanded, sawn, and planed poplar surfaces, indicating that roughness has a strong influence when the amount of the FR is high. The relevance of these results possible only because the measurement is done with the FR's themselves. For fire testes, the retardants were tested in different amounts on varying surface roughness of both solid and particle form wood, using two kinds of natural wood modification via soaking and coating the specimens. Results demonstrate poplar achieved the best fire resistance. As fire retardants, DAHP and DSHP in high amounts obtained the best results in both wood species. Borax displayed excellent flame spread prevention qualities. By combining fire and wettability test results, wettability is inverse proportionate to fire retardancy. This contradicts the original presumption "good wetting gives good fire retardancy". I can state that good wetting FR, doesn't result in good fire resistance. That happens because the bad wettability of FR's created a thin protective layer on the wood surface. A hydration test considered the influence of the fire retardants on cement. Borax did not affect cement curing. On the other hand, PEG 400 had the worst fire resistance, and it prevents cement from curing, make it not suitable for CBPB production. DSHP and DAHP with high amount negatively influenced cement curing, which is expected to decrease the mechanical properties of CBPB. Nevertheless, using the proper amounts of curing agents can alleviate this problem. However, with a decrease in the DAHP and DSHP amount to 25g/l, the cement-setting time of cement hydration decreased, and it is expected to not affect the mechanical properties of CBPB.

Based on all results it was decided to use only high amount of fire retardants. However, DAHP 300 g/l had stronger effect on CBPB curing than expected for this reason it was reduced to

150 g/l. To identify the characteristics and suitability of the used particles, sieving test was made to observe the particle size distribution while sugar and tannin content tests were made to check the suitability of the wood species for CBPB production. It was found that poplar has larger particles than of scots pine. For sugar content, both wood species have sugar content lower than 0.5% which is the requirement for production. Tannin content of scots pine is bigger than of poplar. For scots pine it was 0.45% while for poplar 0.25%. Since wood particles are suitable for production CBPB's of treated and untreated wood particles was made with poplar and scots pine, and standard tests were made to test mechanical physical and fire properties.

Based on standard tests EN 310, EN 317 and EN 319 for physical and mechanical properties of CBPB's, fire retardants at high amounts have reduced the mechanical properties of CBPB's and increased setting time of cement curing as was found in pre-tests for hydration test. CBPB's are significantly affected by the type of additives and kind of pre-treatment in the case of both the Scots pine based and poplar-based panels, with the exception of the thickness swelling of the panels made from Scots pine particles. Most of advantages of pre-treatments on mechanical and physical properties were achieved on poplar. Using additives with 2% of cement weight for SS and 0.2% of cement weight for PDDA+MM as effective for control samples were have no effect on pre-treated CBPB's. However, SS is a good additive with use of 5% of cement weight for Borax and DSHP 77g/l with both wood species, while having a negative effect on DAHP 150 g/l and scots pine control samples. In other hand, PDDA+MM has good influence on the mechanical properties of the CBPB with 20% of cement weight on DSHP 77g/l and DAHP 150 g/l while negative effect on Borax pre-treated CBPB's. The DAHP 150 g/l with both additives at high amount and Borax with PDDA+MM as additive with 20% of cement weight on poplar have positive effect of decreasing the TS to almost 0.5%.

Fire retardants has no significant influence on the increase of fire resistance of scots pine based CBPB except for DAHP 150 g/l with PDDA+MM while has a significant influence on poplar based CBPB. The used additive showed significant effect in both cases Scots pine and poplar based CBPB. The interaction of pre-treatment and additive not significant in case of scots pine while significant in case of poplar based CBPB. Interaction of pre-treatments with PDDA+MM has better effect on fire resistance of the CBPB than of SS. Fire retardants pre-treatments for wood particles used in CBPB production proved as effective pre-treatment to increase the fire resistance of wood. In addition, it could predict the performance of the FR's pre-treatment based on its influence on wood species. For solid wood poplar had better fire resistance with FR's the same

was in case of CBPB. It could state that DAHP 150 g/l has advantage on not only increasing fire resistance of CBPB's but upgrading the fire classification of poplar based CBPB from B-s1, d0 to A<sub>1</sub> with SS as an additive with 5% amount or with PDDA+MM with 20% amount and SS coating. TGA test results came compatible with mechanical and fire test results.

XRD patterns and SEM images show that no new phases appeared in the CBPB's that means no new phase comes out and delay the hydration cement. With combining the XRD patterns and hydration test results it concludes that the effect of the fire retardants on the mechanical properties of the CBPB's more clear now that fire retardants did not dry fast after pre-treatments making the MC in wood particles higher than 30 % that leads to coming out of inhibitors that prevent the cement from fully curing and making more portlandite during the hydration time. DMA proved that temperature have negative influence on the CBPB's and high storage modulus is connected with high MOR and the inverse as well. For both wood species, poplar-based panels have higher loss modulus than of Scots pine-based panels that means that specimens with highest MOR have highest elasticity properties.

## List of literature

- [1] A. Deplazes, Ed., *Constructing architecture: materials, processes, structures, a handbook*. Basel ; Boston: *Birkhäuser-Publishers for Architecture*, 2005.
- [2] K. Zhang and Q. Sun, ‘The use of Wire Mesh-Polyurethane Cement (WM-PUC) composite to strengthen RC T-beams under flexure’, *J. Build. Eng.*, vol. 15, pp. 122–136, Jan. 2018, doi: 10.1016/j.job.2017.11.008.
- [3] S. H. Kosmatka, B. Kerkhoff, and W. C. Panarese, ‘Design and Control of Concrete Mixtures’, *Portland Cement Association*. pp.370. 2002
- [4] V. Marcos-Meson, A. Michel, A. Solgaard, G. Fischer, C. Edvardsen, and T. L. Skovhus, ‘Corrosion resistance of steel fibre reinforced concrete-A literature review’, *Cem. Concr. Res.*, vol. 103, pp. 1–20, 2018.
- [5] X. Zhang, L. Wang, J. Zhang, Y. Ma, and Y. Liu, ‘Flexural behavior of bonded post-tensioned concrete beams under strand corrosion’, *Nucl. Eng. Des.*, vol. 313, pp. 414–424, 2017.
- [6] A. Hillerborg, M. Modéer, and P.-E. Petersson, ‘Analysis of crack formation and crack growth in concrete by means of fracture mechanics and finite elements’, *Cem. Concr. Res.*, vol. 6, no. 6, pp. 773–781, 1976.
- [7] T. L. Alpar, É. Selmeczi, and L. Csoka, ‘Advanced wood cement compatibility with nano mineral’, *Int. Sci. Conf.*, pp. 7, 2012.
- [8] N. Brushlinsky, M. Ahrens, S. Sokolov, and P. Wagner, ‘Center of Fire Statistics. World fire statistics [Internet]. *Report No.: 21. Ljubljana: International Association of Fire and Rescue Services*; 2016’.
- [9] ‘MSZ EN 13501-1:2007+A1:2010 (Fire classification of construction products and building elements. Part 1: Classification using data from reaction to fire tests)’.
- [10] Burning of wood,. [http://virtual.vtt.fi/virtual/innofirewood/stateoftheart/database/burning/burning.html?fbclid=IwAR2tz\\_LqfSi\\_JpwScI2-EbpPk5tEKgJ5qZFOBd5G7BJ2XJDRpTgUg0ghHTc](http://virtual.vtt.fi/virtual/innofirewood/stateoftheart/database/burning/burning.html?fbclid=IwAR2tz_LqfSi_JpwScI2-EbpPk5tEKgJ5qZFOBd5G7BJ2XJDRpTgUg0ghHTc). 28 Feb, 2021
- [11] S. LeVan, *Effects of fire retardant chemicals on the bending properties of wood at elevated temperatures*, vol. 498. US Department of Agriculture, Forest Service, Forest Products Laboratory, 1990.
- [12] Falco Zrt. ‘[https://www.falco-woodindustry.com/Betonyp\\_epitolemez.html](https://www.falco-woodindustry.com/Betonyp_epitolemez.html)’, Apr. 2020.

- [13] MSZ. EN. 310. Determination of modulus of elasticity in bending and of bending strength', 2002.
- [14] MSZ. EN. 319: 1993 Particleboards and fibreboards. Determination of tensile strength perpendicular to the plane of the board'.
- [15] MSZ. EN. 317, '317:1993 Particleboards and Fibreboards—Determination of Swelling in Thickness after Immersion in Water'
- [16] MSZ. EN. ISO, '11925-2. 2011 Reaction to fire tests', *Ignitability Build. Prod. Subj. Direct Impingement Flame Part*, vol. 2.
- [17] MSZ. EN. ISO, '1182: 2010', *Reaction Fire Tests Building Products Non-Combustibility Test ISO 1182 2010*
- [18] J. M. Ferraz, C. H. S. Del Menezzi, M. R. Souza, E. Y. A. Okino, and S. A. Martins, 'Compatibility of Pretreated Coir Fibres ( *Cocos nucifera* L.) with Portland Cement to Produce Mineral Composites', *Int. J. Polym. Sci.*, vol. 2012, pp. 1–7, 2012, doi: 10.1155/2012/290571.
- [19] A. Quiroga, V. Marzocchi, and I. Rintoul, 'Influence of wood treatments on mechanical properties of wood–cement composites and of *Populus Euroamericana* wood fibers', *Compos. Part B Eng.*, vol. 84, pp. 25–32, Jan. 2016, doi: 10.1016/j.compositesb.2015.08.069.
- [20] L. Bej6, P. Tak6ts, and V. Norbert, 'Development of cement bonded composite beams', *Acta Silv. Lignaria Hung.*, vol. 1, pp. 111–119, 2005.
- [21] S. Frybort, R. Mauritz, A. Teischinger, and U. M6ller, 'Cement bonded composites - A mechanical review', *BioResources*, vol. 3, no. 2, pp. 602–626, 2008, doi: 10.15376/biores.3.2.602-626.
- [22] B. Na, Z. Wang, H. Wang, and X. Lu, 'Wood-cement compatibility review', *Wood Res.*, vol. 59, no. 5, pp. 813–826, 2014.
- [23] L. GUNDUZ, S. O. KALKAN, and A. M. ISKER, 'Effects of using Cement-Bonded Particle Boards with a Composite Component in Terms of Acoustic Performance in Outdoor Noise Barriers', *Eurasia Proc. Sci. Technol. Eng. Math.*, no. 4, pp. 246–255, 2018.
- [24] G. Vaickelionis and R. Vaickelioniene, 'Cement hydration in the presence of wood extractives and pozzolan mineral additives', *Ceram. Silik.*, vol. 50, no. 2, pp. 115, 2006.
- [25] A. W. Lee, Z. Hong, D. R. Phillips, and C. Y. Hse, 'Effect of cement/wood ratios and wood storage conditions on hydration temperature, hydration time, and compressive strength of wood-cement mixtures', *Wood Fiber Sci.*, vol. 19, no. 3, pp. 262–268, 2007.

- [26] T. Alpar, A. Pavlekovic, L. Csoka, and L. Horvath, 'Wood wool cement boards produced with nano minerals', *Proceedings 3rd Int. Scientific Conference on Hardwood Processing (ISCHP32011) I: Peer reviewed contributions.*, pp. 75–82. 2011.
- [27] Y. M. Wei, Y. Guang Zhou, and B. Tomita, 'Hydration behavior of wood cement-based composite I: evaluation of wood species effects on compatibility and strength with ordinary portland cement', *J. Wood Sci.*, vol. 46, no. 4, pp. 296–302, Aug. 2000, doi: 10.1007/BF00766220.
- [28] D. D. Stokke, Q. Wu, and G. Han, *Introduction to wood and natural fiber composites*. John Wiley & Sons, pp 4. 2013.
- [29] A. Moslemi and S. C. Pfister, 'The influence of cement/wood ratio and cement type on bending strength and dimensional stability of wood-cement composite panels', *Wood Fiber Sci.*, vol. 19, no. 2, pp. 165–175, 2007.
- [30] D. Hannant, S. V. Siva, and P. R. Sreekanth, '5.15 Cement-Based Composites', Elsevier. 2018.
- [31] S. Medved and J. Resnik, 'Influence of beech particle size used in surface layer on bending strength of three-layer particleboard', *Zb. Gozdarstva Lesar.*, no. 72, pp. 197–207, 2003.
- [32] P. Soroushian, J.-P. Won, and M. Hassan, 'Durability and microstructure analysis of CO<sub>2</sub>-cured cement-bonded wood particleboard', *Cem. Concr. Compos.*, vol. 41, pp. 34–44, Aug. 2013, doi: 10.1016/j.cemconcomp.2013.04.014.
- [33] L. Wang, S. S. Chen, D. C. W. Tsang, C.-S. Poon, and J.-G. Dai, 'CO<sub>2</sub> curing and fibre reinforcement for green recycling of contaminated wood into high-performance cement-bonded particleboards', *J. CO<sub>2</sub> Util.*, vol. 18, pp. 107–116, Mar. 2017, doi: 10.1016/j.jcou.2017.01.018.
- [34] A. Ashori, T. Tabarsa, and F. Amosi, 'Evaluation of using waste timber railway sleepers in wood–cement composite materials', *Constr. Build. Mater.*, vol. 27, no. 1, pp. 126–129, 2012.
- [35] L. Wang, K.M. Iris, D.C.W. Tsang, S. Li, J. Li, C.S. Poon. 'Transforming wood waste into water-resistant magnesia-phosphate cement particleboard modified by alumina and red mud', *J. Clean. Prod.*, vol. 168, pp. 452–462, 2017.
- [36] L. Wang *et al.*, 'Upcycling wood waste into fibre-reinforced magnesium phosphate cement particleboards', *Constr. Build. Mater.*, vol. 159, pp. 54–63, Jan. 2018, doi: 10.1016/j.conbuildmat.2017.10.107.

- [37] B. Koohestani, A. Koubaa, T. Belem, B. Bussière, and H. Bouzahzah, 'Experimental investigation of mechanical and microstructural properties of cemented paste backfill containing maple-wood filler', *Constr. Build. Mater.*, vol. 121, pp. 222–228, 2016, doi: 10.1016/j.conbuildmat.2016.05.118.
- [38] T.M Malloney, 'composition board materials: properties and testing of modern particle and dry process fibreboard', *Manufacturing*, pp. 120–128, 1989.
- [39] S. Mohammed and O. Safiullah, 'Optimization of the SO<sub>3</sub> content of an Algerian Portland cement: Study on the effect of various amounts of gypsum on cement properties', *Constr. Build. Mater.*, vol. 164, pp. 362–370, 2018.
- [40] J. W. Bullard *et al.*, 'Mechanisms of cement hydration', *Cem. Concr. Res.*, vol. 41, no. 12, pp. 1208–1223, 2011.
- [41] F. C. Jorge, C. Pereira, and J. M. F. Ferreira, 'Wood-cement composites: a review', *Holz Als Roh- Werkst.*, vol. 62, no. 5, pp. 370–377, 2004, doi: 10.1007/s00107-004-0501-2.
- [42] S. R. Karade, 'Cement-bonded composites from lignocellulosic wastes', *Constr. Build. Mater.*, vol. 24, no. 8, pp. 1323–1330, 2010, doi: 10.1016/j.conbuildmat.2010.02.003.
- [43] K. Kochova, K. Schollbach, F. Gauvin, and H. J. H. Brouwers, 'Effect of saccharides on the hydration of ordinary Portland cement', *Constr. Build. Mater.*, vol. 150, pp. 268–275, 2017, doi: 10.1016/j.conbuildmat.2017.05.149.
- [44] M. Fan, M. K. Ndikontar, X. Zhou, and J. N. Ngamveng, 'Cement-bonded composites made from tropical woods: Compatibility of wood and cement', *Constr. Build. Mater.*, vol. 36, pp. 135–140, 2012, doi: 10.1016/j.conbuildmat.2012.04.089.
- [45] A. Ashori, T. Tabarsa, K. Azizi, and R. Mirzabeygi, 'Wood-wool cement board using mixture of eucalypt and poplar', *Ind. Crops Prod.*, vol. 34, no. 1, pp. 1146–1149, 2011, doi: 10.1016/j.indcrop.2011.03.033.
- [46] V. G. de Castro, R. da R. Azambuja, C. F. A. Parchen, and S. Iwakiri, 'Alternative vibro-dynamic compression processing of wood-cement composites using Amazonian wood', *Acta Amaz.*, vol. 49, no. 1, pp. 75–80, 2019.
- [47] C. Antwi-Boasiako, L. Ofosuhene, and K. B. Boadu, 'Suitability of sawdust from three tropical timbers for wood-cement composites', *J. Sustain. For.*, vol. 37, no. 4, pp. 414–428, 2018.
- [48] X. Wang and Y. Yu, 'The compatibility of two common fast-growing species with Portland cement', *J. Indian Acad. Wood Sci.*, vol. 9, no. 2, pp. 154–159, 2012.

- [49] H. A. Al-Mefarrej, 'Testing and Enhancing The Compatibility of Five Saudi Wood Species for Cement-Bonded Particleboard Industry'. *Alexandria Science Exchange Journal* 30 (3), pp. 333-342. 2009
- [50] A. N. Papadopoulos, 'physical-mechanical properties and durability against basidiomycetes of particleboards made from cement and carpinus betulus L. wood particles', *wood Res.*, vol. 54, no. 2, pp. 95–100, 2009.
- [51] K. Kochova, V. Caprai, F. Gauvin, K. Schollbach, and H. J. H. Brouwers, 'Investigation of local degradation in wood stands and its effect on cement wood composites', *Constr. Build. Mater.*, vol. 231, pp. 117201, 2020, doi: 10.1016/j.conbuildmat.2019.117201.
- [52] S. A. Pasca, I. D. Hartley, M. E. Reid, and R. W. Thring, 'Evaluation of Compatibility between Beetle-Killed Lodgepole Pine (*Pinus Contorta* var. *Latifolia*) Wood with Portland Cement', *Materials*, vol. 3, no. 12, pp. 5311–5319, 2010, doi: 10.3390/ma3125311.
- [53] R. A. Nasser and H. A. Al-Mefarrej, 'Midribs of Date Palm as a Raw Material for Wood-Cement Composite Industry in Saudi Arabia'. *world Appl. Sci. J*, pp. 8, 2011.
- [54] V. Castro, R. D. Araújo, C. Parchen, and S. Iwakiri, 'Evaluation of pretreatment effects of *Eucalyptus benthamii* Maiden & Cambage wood on the compatibility degree with Portland cement.', *Rev. Árvore*, vol. 38, no. 5, pp. 935–942, 2014.
- [55] D. Jiang, S. Cui, F. Xu, and T. Tuo, 'Impact of leaf fibre modification methods on compatibility between leaf fibres and cement-based materials', *Constr. Build. Mater.*, vol. 94, pp. 502–512, Sep. 2015, doi: 10.1016/j.conbuildmat.2015.07.045.
- [56] X. Xie *et al.*, 'Influence of pretreatment of rice straw on hydration of straw fiber filled cement based composites', *Constr. Build. Mater.*, vol. 113, pp. 449–455, 2016.
- [57] R. A. Nasser, M. Z. M. Salem, H. A. Al-Mefarrej, and I. M. Aref, 'Use of tree pruning wastes for manufacturing of wood reinforced cement composites', *Cem. Concr. Compos.*, vol. 72, pp. 246–256. 2016, doi: 10.1016/j.cemconcomp.2016.06.008.
- [58] L. Cechin, A. Matoski, A. Lima, A. Weber, and R. Tokarski, 'Effect of treatments on high initial strength portland cement and mosso bamboo compatibility', *Rev. Ing. Constr.*, vol. 33, no. 2, pp. 127–136, 2018.
- [59] V. G. Castro, R. da R. Azambuja, N. F. Bila, C. F. A. Parchen, G. I. Sasaki, and S. Iwakiri, 'Correlation between chemical composition of tropical hardwoods and wood–cement compatibility', *J. Wood Chem. Technol.*, vol. 38, no. 1, pp. 28–34, 2018.
- [60] H. A. Abdelrhman, M. T. Paridah, M. Shahwahid, A. R. A. Samad, and A. M. A. Abdalla, 'The effects of pre-treatments, wood-cement ratios and partial cement substitution by

- gypsum on *Prosopis chilensis* wood composites', *Eur. J. Wood Wood Prod.*, vol. 73, no. 4, pp. 557–559, Jul. 2015, doi: 10.1007/s00107-015-0909-x.
- [61] A. Ashori, T. Tabarsa, and S. Sepahvand, 'Cement-bonded composite boards made from poplar strands', *Constr. Build. Mater.*, vol. 26, no. 1, pp. 131–134, 2012, doi: 10.1016/j.conbuildmat.2011.06.001.
- [62] K. B. Boadu, C. Antwi-Boasiako, and L. Ofosuhene, 'Solvent extraction of inhibitory substances from three hardwoods of different densities and their compatibility with cement in composite production', *J. Indian Acad. Wood Sci.*, vol. 15, no. 2, pp. 140–148, 2018, doi: 10.1007/s13196-018-0219-0.
- [63] T. Tabarsa and A. Ashori, 'Dimensional Stability and Water Uptake Properties of Cement-Bonded Wood Composites', *J. Polym. Environ.*, vol. 19, no. 2, pp. 518–521, 2011, doi: 10.1007/s10924-011-0295-3.
- [64] and L. H. Tibor L. Alparl\*, Andras A. Pavlekovics1, Levente Csoka1, 'Wood Wool Cement Boards Produced with Nano Minerals', *Int. Sci. Conf. Hardwood Process. ISCHP2011*, no. 75–82, 2011.
- [65] O. A. Sotannde, A. O. Oluwadare, O. Ogedoh, and P. F. Adeogun, 'evaluation of Cement-Bonded Particle Board Produced From Afzella African Wood Residues', vol. 7, pp. 12, 2012.
- [66] A. Matoski, M. M. Hara, S. Iwakiri, and J. M. Casali, 'Influence of accelerating admixtures in wood-cement panels: characteristics and properties - doi: 10.4025/actascitechnol.v35i4.11261', *Acta Sci. Technol.*, vol. 35, no. 4, pp. 655–660, Oct. 2013, doi: 10.4025/actascitechnol.v35i4.11261.
- [67] M. Nazerian and V. Sadeghiipannah, 'Cement-bonded particleboard with a mixture of wheat straw and poplar wood', *J. For. Res.*, vol. 24, no. 2, pp. 381–390, Jun. 2013, doi: 10.1007/s11676-013-0363-8.
- [68] M. S. Mahzabin, R. Hamid, and W. H. W. Badaruzzaman, 'Evaluation of Chemicals Incorporated Wood Fibre Cement Matrix Properties', *Journal of Engineering Science and Technology* Vol. 8, No. 4. 385 - 398 2013.
- [69] Makoving I, 'Microwave drying of wood cement composites', *Wood Res.*, vol. 55, no. 2, pp. 115–124, 2010.
- [70] T. ALPÁR, P. TAKÁTS, and Y. HATANO, 'Porosity of cement-bonded particleboards hardened by CO<sub>2</sub> injection and cured by hydration', *Jpn. Agric. Res. Q. JARQ*, vol. 37, no. 4, pp. 263–268, 2003.

- [71] H. Qi, P. A. Cooper, and D. Hooton, 'The investigation of basic processes of rapidly hardening wood-cement-water mixture with CO<sub>2</sub>', *Eur. J. Wood Wood Prod.*, vol. 68, no. 1, pp. 35–41, 2010, doi: 10.1007/s00107-009-0351-z.
- [72] I. Taskirawati, D. Sanusi, B. Baharuddin, A. Agussalim, and S. Suhasman, 'Characteristics of Cement Board with CO<sub>2</sub> Injection Method added CaCl<sub>2</sub> as Additive Using Two Wood Species from Community Forests', *IOP Conf. Ser. Earth Environ. Sci.*, vol. 270, pp. 012055, May 2019, doi: 10.1088/1755-1315/270/1/012055.
- [73] R. S. Maail, 'Degradation Analysis on Manufacture of Cement-bonded Particleboard Using Supercritical CO<sub>2</sub>', *Wood Res. J.*, vol. 4, no. 2, pp. 76–82, 2017.
- [74] R. S. Maail, K. Umemura, H. Aizawa, and S. Kawai, 'Curing and degradation processes of cement-bonded particleboard by supercritical CO<sub>2</sub> treatment', *J. Wood Sci.*, vol. 57, no. 4, pp. 302–307. 2011, doi: 10.1007/s10086-011-1179-9.
- [75] D. M. S. Hassan, 'Strength Evaluation of CO<sub>2</sub>-Cured Cellulose Date Palm Fiber Reinforced Cementitious Boards', *Eng. and Tech. Journal*, Vol 34, part (A). pp. 1029-1046, 2016.
- [76] B. Marteinsson and E. Gudmundsson, 'Cement Bonded Particle Boards with Different Types of Natural Fibres—Using Carbon Dioxide Injection for Increased Initial Bonding', *Open J. Compos. Mater.*, vol. 08, no. 01, pp. 28–42, 2018, doi: 10.4236/ojcm.2018.81003.
- [77] P. Soroushian, J.-P. Won, and M. Hassan, 'Durability characteristics of CO<sub>2</sub>-cured cellulose fiber reinforced cement composites', *Constr. Build. Mater.*, vol. 34, pp. 44–53, 2012, doi: 10.1016/j.conbuildmat.2012.02.016.
- [78] Y. Zuo, J. Xiao, J. Wang, W. Liu, X. Li, and Y. Wu, 'Preparation and characterization of fire retardant straw/magnesium cement composites with an organic-inorganic network structure', *Constr. Build. Mater.*, vol. 171, pp. 404–413, 2018, doi: 10.1016/j.conbuildmat.2018.03.111.
- [79] J. Saval, R. Lapuente, V. Navarro, and A. J. Tenza-Abril, 'Fire-resistance, physical, and mechanical characterization of particleboard containing Oceanic Posidonia waste', *Mater. Constr.*, vol. 64, no. 314, pp. 019, 2014.
- [80] Y. Yu, J. Hou, Z. Dong, C. Wang, F. Lu, and P. Song, 'Evaluating the flammability performance of Portland cement-bonded particleboards with different cement–wood ratios using a cone calorimeter', *J. Fire Sci.*, vol. 34, no. 3, pp. 199–211, 2016.
- [81] H. W. Emmons and A. Atreya, 'The science of wood combustion', *Proc. Indian Acad. Sci. Sect. C Eng. Sci.*, vol. 5, no. 4, pp. 259, 1982.

- [82] L. A. Lowden and T. R. Hull, 'Flammability behaviour of wood and a review of the methods for its reduction', *Fire Sci. Rev.*, vol. 2, no. 1, pp. 1–19, 2013.
- [83] L. A. Medina and R. Schledjewski, 'Water glass as hydrophobic and flame retardant additive for natural fibre reinforced composites', *J Nanostruct Polym Nanocompos*, vol. 5, pp. 107–114, 2009.
- [84] N. Ayrilmis, T. Dunder, Z. Candan, and T. Akbulut, 'Wettability of fire retardant treated laminated veneer lumber (LVL) manufactured from veneers dried at different temperatures', *BioResources*, vol. 4, no. 4, pp. 1536–1544, 2009.
- [85] C. Popescu and A. Pfriem, 'Treatments and modification to improve the reaction to fire of wood and wood based products—An overview', *Fire Mater.*, vol. 44, no. 1, pp. 100–111, 2020.
- [86] R. Stevens, D. S. van Es, R. Bezemer, and A. Kranenbarg, 'The structure–activity relationship of fire retardant phosphorus compounds in wood', *Polym. Degrad. Stab.*, vol. 91, no. 4, pp. 832–841, 2006, doi: 10.1016/j.polymdegradstab.2005.06.014.
- [87] I. van der Veen and J. de Boer, 'Phosphorus flame retardants: Properties, production, environmental occurrence, toxicity and analysis', *Chemosphere*, vol. 88, no. 10, pp. 1119–1153, 2012, doi: 10.1016/j.chemosphere.2012.03.067.
- [88] J. Jiang, J. Li, J. Hu, and D. Fan, 'Effect of nitrogen phosphorus flame retardants on thermal degradation of wood', *Constr. Build. Mater.*, vol. 24, no. 12, pp. 2633–2637, 2010, doi: 10.1016/j.conbuildmat.2010.04.064.
- [89] C. S. Wu, Y. L. Liu, and Y. S. Chiu, 'Epoxy resins possessing Flame retardant elements from silicon incorporated epoxy compounds cured with phosphorus or nitrogen containing curing agents', *Polymer*, 43(15), 4277-4284, 2002.
- [90] F. Gao, L. Tong, and Z. Fang, 'Effect of a novel phosphorous–nitrogen containing intumescent flame retardant on the fire retardancy and the thermal behaviour of poly(butylene terephthalate)', *Polym. Degrad. Stab.*, vol. 91, no. 6, pp. 1295–1299, 2006, doi: 10.1016/j.polymdegradstab.2005.08.013.
- [91] Y. L. Liu, 'Flame-retardant epoxy resins from novel phosphorus-containing novolac', *Polymer*, vol. 42, no. 8, pp. 3445–3454, 2001, doi: 10.1016/S0032-3861(00)00717-5.
- [92] L. Russell, D. Marney, D. Humphrey, A. Hunt, V. Dowling, and L. Cookson, 'Combining fire retardant and preservative systems for timber products in exposed applications—state of the art review', *Aust. For. Wood Prod. R Corp. Vic.*, 2007.

- [93] K. Kishore and K. Mohandas, 'Action of phosphorus compounds on fire-retardancy of cellulosic materials: A review', *Fire Mater.*, vol. 6, no. 2, pp. 54–58, 1982.
- [94] P. Sayan, S. T. Sargut, and B. Kiran, 'Effect of impurities on the microhardness of borax decahydrate', *Powder Technol.*, vol. 197, no. 3, pp. 254–259, 2010, doi: 10.1016/j.powtec.2009.09.025.
- [95] E. Baysal, M. K. Yalinkilic, M. Altinok, A. Sonmez, H. Peker, and M. Colak, 'Some physical, biological, mechanical, and fire properties of wood polymer composite (WPC) pretreated with boric acid and borax mixture', *Constr. Build. Mater.*, vol. 21, no. 9, pp. 1879–1885, 2007, doi: 10.1016/j.conbuildmat.2006.05.026.
- [96] K. Ozkaya, A. Cemil Ilce, E. Burdurlu, and S. Aslan, 'The effect of potassium carbonate, borax and wolmanit on the burning characteristics of oriented strandboard (OSB)', *Constr. Build. Mater.*, vol. 21, no. 7, pp. 1457–1462, 2007, doi: 10.1016/j.conbuildmat.2006.07.001.
- [97] E. Terzi, 'Thermal Degradation of Particleboards Incorporated with Colemanite and Common Boron-based Fire Retardants', *BioResources*, vol. 13, no. 2, pp. 4239–4251, 2018.
- [98] N. Ayrimis *et al.*, 'Effect of boron and phosphate compounds on physical, mechanical, and fire properties of wood–polypropylene composites', *Constr. Build. Mater.*, vol. 33, pp. 63–69, 2012.
- [99] P. Kannan and K. Kishore, 'Polyethylene stibinite phosphate esters: Novel flame-retardant plasticizers for PVC', *Eur. Polym. J.*, vol. 33, no. 10–12, pp. 1799–1803, 1997, doi: 10.1016/S0014-3057(97)00061-X.
- [100] F. Z. Brahmia and T. Alpár, 'Flame retardancy of Scots pine (*Pinus sylvestris*) by using polyethylene glycol 400 and phosphoric acid.', *Int. J. Psychosoc. Rehabil.*, vol. 24, no. 4, 2020.
- [101] Y. Shi and G. Wang, 'Influence of molecular weight of PEG on thermal and fire protection properties of PEPA-containing polyether flame retardants with high water solubility', *Prog. Org. Coat.*, vol. 90, pp. 390–398, 2016, doi: 10.1016/j.porgcoat.2015.08.005.
- [102] G.-Y. Xu, W. Han, C.-W. Cheng, H.-Q. Zhang, J.-M. Cao, and G.-B. Ji, 'Synthesis of single crystalline CdS nanowires with polyethylene glycol 400 as inducing template', *Trans. Nonferrous Met. Soc. China*, vol. 16, no. 1, pp. 105–109, 2006.
- [103] M. Raghu, M. Rajasekhar, B. C. O. Reddy, C. S. Reddy, and B. S. Reddy, 'Polyethylene glycol (PEG-400): A mild and efficient reaction medium for one-pot synthesis of 3-hydroxy-3-(pyridin-2-ylmethyl) indolin-2-ones', *Tetrahedron Lett.*, vol. 54, no. 27, pp. 3503–3506, 2013.

- [104] F. Fu, L. Lin, and E. Xu, 'Functional pretreatments of natural raw materials', in *Advanced High Strength Natural Fibre Composites in Construction*, Elsevier, 2017, pp. 87–114.
- [105] R. M. Rowell, *Handbook of wood chemistry and wood composites*. CRC press, 2012.
- [106] M. Petrič, 'Surface modification of wood', *Rev. Adhes. Adhes.*, vol. 1, no. 2, pp. 216–247, 2013.
- [107] I. Varivodina, N. Kosichenko, and N. Nedelina, 'wood porosity depending on histological structure', *Wood Best Mater. Mank.*, pp. 7, 2013.
- [108] L. Benomar, A. DesRochers, and G. R. Larocque, 'The effects of spacing on growth, morphology and biomass production and allocation in two hybrid poplar clones growing in the boreal region of Canada', *Trees*, vol. 26, no. 3, pp. 939–949. 2012, doi: 10.1007/s00468-011-0671-6.
- [109] I. Ištók, T. Sedlar, B. Šefc, T. Sinković, and T. Perković, 'Physical properties of wood in poplar clones' I-214'and'S1-8'', *Drv. Ind. Znan. Časopis Za Pitanja Drv. Tehnol.*, vol. 67, no. 2, pp. 163–170, 2016.
- [110] J. Y. Zhu, C. T. Scott, K. L. Scallon, and G. C. Myers, 'effects of plantation density on wood density and anatomical properties of red pine (*Pinus Resinosa* Ait.)', *Wood Fiber Sci.*, vol. 39, p. 11, 2007.
- [111] '[https://www.falco-woodindustry.com/Betonyp\\_epitolemez.html](https://www.falco-woodindustry.com/Betonyp_epitolemez.html)', Apr. 2020.
- [112] T. Alpár and I. Rácz, 'Production of cement-bonded particleboards from poplar (*Populus euramericana* cv. „I 214“)', *Drv. Ind.*, p. 6, 2009.
- [113] S. Molnár and M. Bariska, *Wood species of Hungary*. Budapest, 2002.
- [114] I. Turku, M. Nikolaeva, and T. Kärki, 'The effect of fire retardants on the flammability, mechanical properties, and wettability of co-extruded PP-based wood-plastic composites', *BioResources*, vol. 9, no. 1, pp. 1539–1551, 2014.
- [115] L. Kong, H. Guan, and X. Wang, 'In situ polymerization of furfuryl alcohol with ammonium dihydrogen phosphate in poplar wood for improved dimensional stability and flame retardancy', *ACS Sustain. Chem. Eng.*, vol. 6, no. 3, pp. 3349–3357, 2018.
- [116] N. Ayrilmis, 'Effect of fire retardants on surface roughness and wettability of wood plastic composite panels', *BioResources*, vol. 6, no. 3, pp. 3178–3187, 2011.
- [117] N. Ayrilmis, S. Korkut, E. Tanritanir, J. E. Winandy, and S. Hiziroglu, 'Effect of various fire retardants on surface roughness of plywood', *Build. Environ.*, vol. 41, no. 7, pp. 887–892, 2006, doi: 10.1016/j.buildenv.2005.04.011.

- [118] L. Rábai, 'Különböző ültetvényekről származó Pannónia Nyár faanyagok nedvesíthetőségének vizsgálata', Sopron University. MSc Thesis. 2018.
- [119] E. A. Papp and C. Csiha, 'Contact angle as function of surface roughness of different wood species', *Surf. Interfaces*, vol. 8, pp. 54–59, 2017.
- [120] K. Richter, W. C. Feist, and T. Knaebe, 'The effect of surface roughness on the performance of finishes. Part 1. Roughness characterization and stain performance.', *For. Prod. J.*, no. 45 (7/8), pp. 91–97, 1995.
- [121] E. Magoss, *General Regularities of the Wood Surface Roughness: A new approach for wood species characterisation*, no. 1. Nyugat-Magyarországi Egyetem Faipari Mérnöki Kar, 2008.
- [122] X. Wang, F. Wang, Z. Yu, Y. Zhang, C. Qi, and L. Du, 'Surface free energy and dynamic wettability of wood simultaneously treated with acidic dye and flame retardant', *J. Wood Sci.*, vol. 63, no. 3, pp. 271–280, 2017.
- [123] Y. Yuan, T. Lee, G. Bracco, and B. Holst, 'Surface Science Techniques, Springer Series in Surface Sciences', 2013.
- [124] R. N. Wenzel, 'Resistance of solid surfaces to wetting by water', *Ind. Eng. Chem.*, vol. 28, no. 8, pp. 988–994, 1936.
- [125] Y. Thomas, 'An essay on the cohesion of fluids', *Philos Trans R Soc Lond.*, vol. 95, pp. 65–87, 1805.
- [126] L. Gurau, C. Csiha, and H. Mansfield-Williams, 'Processing roughness of sanded beech surfaces', *Eur. J. Wood Wood Prod.*, vol. 73, no. 3, pp. 395–398, 2015.
- [127] L. GURÁU, 'Analysis of roughness of sanded oak and beech surfaces.', *Ligno*, vol. 9, no. 4, 2013.
- [128] E. Magoss, 'Evaluating of the surface roughness of sanded wood', *Wood Res.*, vol. 60, no. 5, pp. 783–790, 2015.
- [129] E. Oberhofnerová and M. Pánek, 'Surface Wetting of Selected Wood Species by Water During Initial Stages of Weathering', *Wood Res.*, vol. 61, pp. 8, 2016.
- [130] Z. Qin, Q. Gao, S. Zhang, and J. Li, 'Surface Free Energy and Dynamic Wettability of Differently Machined Poplar Woods', *BioResources*, vol. 9, no. 2, pp. 3088–3103, 2014, doi: 10.15376/biores.9.2.3088-3103.
- [131] I. Mohammed-Ziegler, Z. Hórvölgyi, A. Tóth, W. Forsling, and A. Holmgren, 'Wettability and spectroscopic characterization of silylated wood samples', *Polym. Adv. Technol.*, vol. 17, no. 11–12, pp. 932–939, Nov. 2006, doi: 10.1002/pat.778.

- [132] L. Gurau and M. Irle, 'Surface roughness evaluation methods for wood products: A review', *Curr. For. Rep.*, vol. 3, no. 2, pp. 119–131, 2017.
- [133] E. Magoss, 'General Regularities of Wood Surface Roughness', *Acta Silvatica et Lignaria Hungarica*, (4), pp.81-93., 2008.
- [134] MSZ EN ISO 4288:1996, 'Geometrical Product Specifications (GPS)—Surface Texture: Profile Method: Rules and Procedures for the Assessment of Surface Texture'.
- [135] M. Amrei, M. Davoudi, G. Chase, and H. V. Tafreshi, 'Effects of roughness on droplet apparent contact angles on a fiber', *Sep. Purif. Technol.*, vol. 180, pp. 107–113, 2017.
- [136] K. Eid, M. Panth, and A. Sommers, 'The physics of water droplets on surfaces: exploring the effects of roughness and surface chemistry', *Eur. J. Phys.*, vol. 39, no. 2, p. 025804, 2018.
- [137] F. Z. Brahmia, T. Alpár, P. G. Horváth, and C. Csiha, 'Comparative analysis of wettability with fire retardants of Poplar (*Populus cv. euramericana I214*) and Scots pine (*Pinus sylvestris*)', *Surf. Interfaces*, vol. 18, p. 100405, Mar. 2020, doi: 10.1016/j.surfin.2019.100405.
- [138] MSZ 9607-1:1983', *Fire Prot. Test. Wood Wood Substituting Mater. Treat. Flame Retard. Subst. Method Linder*, vol. 2, pp. 9607–1.
- [139] MSZ EN ISO 1716: 2018', *React. Fire Tests Prod. Determ. Gross Heat Combust. Calorific Value*.
- [140] 'MSZ EN 634-2:2007- Cement-bonded particleboards - Specifications - Part 2: Requirements for OPC bonded particleboards for use in dry, humid and exterior conditions',
- [141] 'MSZ EN 13501-1:2007+A1:2010 (Fire classification of construction products and building elements. Part 1: Classification using data from reaction to fire tests)'.
- [142] C. Croarkin, P. Tobias, J. Filliben, B. Hembree, and W. Guthrie, 'NIST/SEMATECH e-handbook of statistical methods', *NISTSEMATECH July Available Online Httpwww Itl Nist Govdiv898handbook*, 2006.
- [143] A. Demir and I. Aydin, 'Investigation of some surface properties and thermogravimetric analysis of veneer sheets treated with fire retardants', *Maderas Cienc. Tecnol.*, vol. 21, no. 1, pp. 25–34, 2019.
- [144] A. Aguilera and H. Muñoz, 'Rugosidad superficial y potencia de corte en el cepillado de *Acacia melanoxylon* y *Sequoia sempervirens*', *Maderas Cienc. Tecnol.*, vol. 13, no. 1, pp. 19–28, 2011.

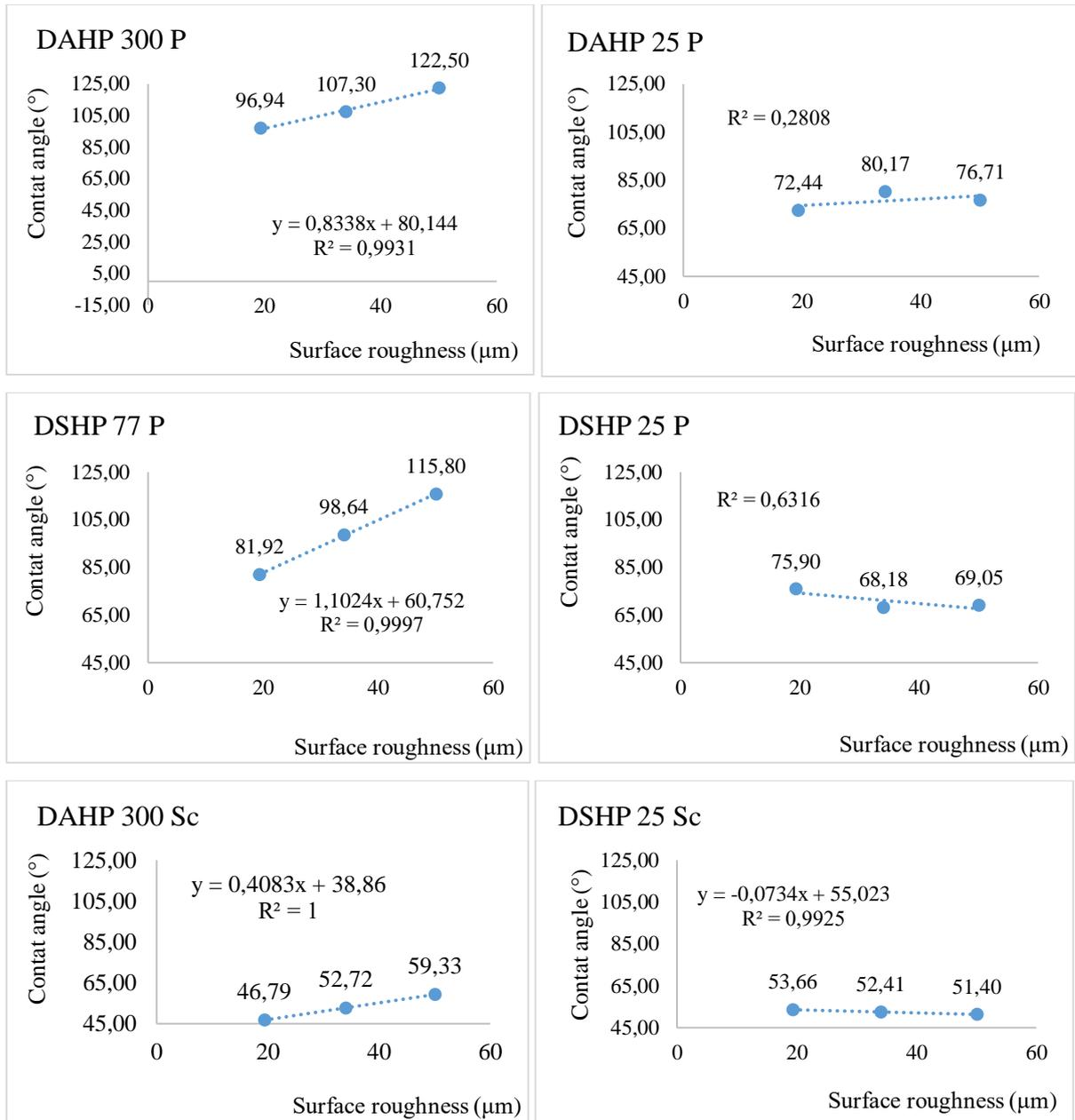
- [145] L. Gurau, H. Mansfield-Williams, and M. Irle, 'The influence of wood anatomy on evaluating the roughness of sanded solid wood', *J. Inst. Wood Sci.*, vol. 17, no. 2, pp. 65–74, 2005.
- [146] Y. Kim, D. Rana, T. Matsuura, W.-J. Chung, and K. C. Khulbe, 'Relationship between surface structure and separation performance of poly (ether sulfone) ultra-filtration membranes blended with surface modifying macromolecules', *Sep. Purif. Technol.*, vol. 72, no. 2, pp. 123–132, 2010.
- [147] Y. Kim, D. Rana, T. Matsuura, and W.-J. Chung, 'Influence of surface modifying macromolecules on the surface properties of poly (ether sulfone) ultra-filtration membranes', *J. Membr. Sci.*, vol. 338, no. 1–2, pp. 84–91, 2009.
- [148] Q. Zhiyong, H. Chen, Q. Gao, S. Zhang, and J. Li, 'Wettability of sanded and aged fast-growing poplar wood surfaces: I. Surface free energy', *BioResources*, vol. 10, no. 1, pp. 1008–1023, 2015.
- [149] E. Baysal, 'Combustion properties of wood impregnated with commercial fertilizers', *Afr. J. Biotechnol.*, vol. 10, no. 82, pp. 18255–18260, 2011.
- [150] D.-W. Son, M.-R. Kang, J.-I. Kim, and S.-B. Park, 'Fire performance of the wood treated with inorganic fire retardants', *J. Korean Wood Sci. Technol.*, vol. 40, no. 5, pp. 335–342, 2012.
- [151] N. P. G. Suardana, M. S. Ku, and J. K. Lim, 'Effects of diammonium phosphate on the flammability and mechanical properties of bio-composites', *Mater. Des.*, vol. 32, no. 4, pp. 1990–1999, 2011.
- [152] E. Terzi, S. N. Kartal, R. H. White, K. Shinoda, and Y. Imamura, 'Fire performance and decay resistance of solid wood and plywood treated with quaternary ammonia compounds and common fire retardants', *Eur. J. Wood Wood Prod.*, vol. 69, no. 1, pp. 41–51, 2011.
- [153] S. Frybort, R. Mauritz, A. Teischinger, and U. Müller, 'Cement Bonded Composites – a Mechanical Review', *BioResources*, 3(2), 602-626.2008.
- [154] C. Klasz, 'Különböző fafajok hatása a cement hidratációjára', Sopron University. Thesis, 2008.
- [155] F. Z. Brahmia, P. G. Horváth, and T. L. Alpár, 'Effect of Pre-Treatments and Additives on the Improvement of Cement Wood Composite: A Review', *BioResources*, vol. 15, no. 3, pp. 7288–7308, 2020.
- [156] S. KEMÉNY and A. DEÁK, 'Kísérletek tervezése és értékelése, Műszaki Könyvkiadó, Budapest, 492 old', 2000.

- [157] Y. Yu, J. Hou, Z. Dong, C. Wang, F. Lu, and P. Song, 'Evaluating the flammability performance of Portland cement-bonded particleboards with different cement–wood ratios using a cone calorimeter', *J. Fire Sci.*, vol. 34, no. 3, Art. no. 3, 2016.
- [158] F. Z. Brahmia, K. Zsolt, P. G. Horváth, and T. L. Alpar, 'Comparative study on fire retardancy of various wood species treated with PEG 400, phosphorus, and boron compounds for use in cement-bonded wood-based products', *Surf. Interfaces*, p. 100736, 2020.
- [159] H. Yel, A. D. Cavdar, and S. B. Torun, 'Effect of press temperature on some properties of cement bonded particleboard', *Maderas Cienc. Tecnol.*, 22(1), 83-92, 2020.
- [160] H.-S. Kim, S. Kim, H.-J. Kim, and H.-S. Yang, 'Thermal properties of bio-flour-filled polyolefin composites with different compatibilizing agent type and content', *Thermochim. Acta*, vol. 451, no. 1–2, pp. 181–188, 2006.
- [161] M. R. Cabral, E. Y. Nakanishi, and J. Fiorelli, 'Cement-bonded panels produced with sugarcane bagasse cured by accelerated carbonation', *J. Mater. Civ. Eng.*, vol. 30, no. 6, p. 04018103, 2018.
- [162] P. K.-J. Philippou, 'Thermogravimetric Analysis of Fire Retardants Treated particleboards. *Wood and Fire Safety.*, pp 385-394. 2000'.
- [163] N. Saba, M. Jawaid, O. Y. Alothman, and M. Paridah, 'A review on dynamic mechanical properties of natural fibre reinforced polymer composites', *Constr. Build. Mater.*, vol. 106, pp. 149–159, 2016.
- [164] W.-J. Long, J.-J. Wei, H. Ma, and F. Xing, 'Dynamic Mechanical Properties and Microstructure of Graphene Oxide Nanosheets Reinforced Cement Composites', *Nanomaterials*, vol. 7, no. 12, Art. no. 12, Nov. 2017, doi: 10.3390/nano7120407.
- [165] RET 2004 Regional University Knowledge-base on utilization of Forests and Wood. annual report: Examination of cement compatibility of poplar hybrids. Sopron University.2008.

# Appendix

## List of Theses

- Several FR's have been tested in order to find the most convenient ones for improving the fire resistance of poplar and Scot's pine particles and how to use them: Borax ( $Na_2B_4O_7$ ), DSHP ( $Na_2HPO_4$ ), DAHP ( $(NH_2)_4HPO_4$ ). I proved that poplar's wettability is worse than the one Scots pine and contact angle values of poplar have been significantly higher, irrelevant from machining type relative to Scots Pine. With increasing concentration of the FR, the wettability of poplar gets worse, whilst the wettability of Scots pine remains mostly unchanged and the contact angle values of sanded, sawn and planed poplar surfaces are significantly different, indicating that roughness has a strong influence when the concentration of the FR is high See Fig. I.1. [\[FZB-JP-1\]](#), [\[FZB-JP-4\]](#), [\[FZB-CP-1\]](#), [\[FZB-CP-2\]](#)



## Appendix

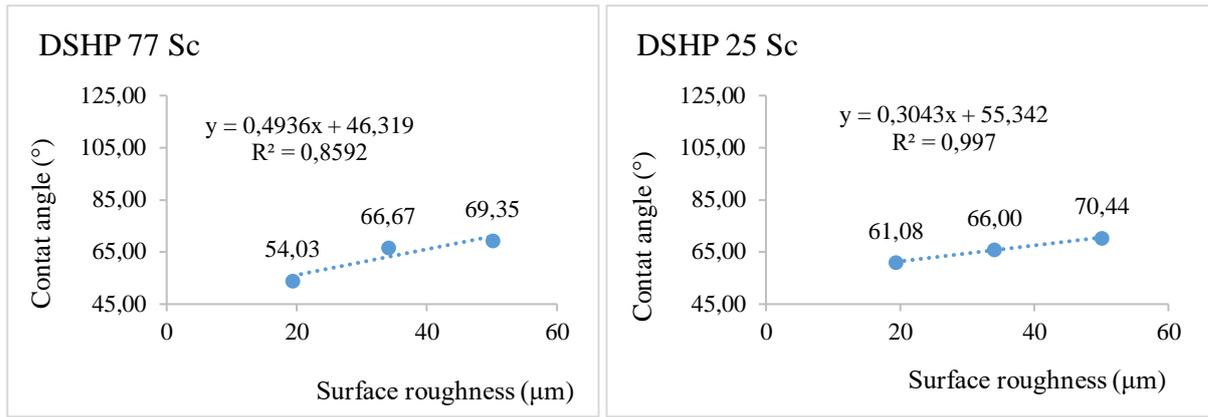


Figure I.1: Relation between surface roughness (µm) and contact angle (°) of fire retardants for (P) poplar and (S)c Scots' pine.

2. I proved that the best fire resistance has been achieved on Poplar, and in case of both species at high concentrations of DAHP and DSHP. Wettability has been found to be invers proportionate to fire retardancy. This contradicts the original presumption “good wetting gives good fire retardancy”. I can state that good wetting FR, doesn't result good fire resistance.

[\[FZB-JP-1\]](#), [\[FZB-JP-4\]](#), [\[FZB-CP-1\]](#), [\[FZB-CP-2\]](#)

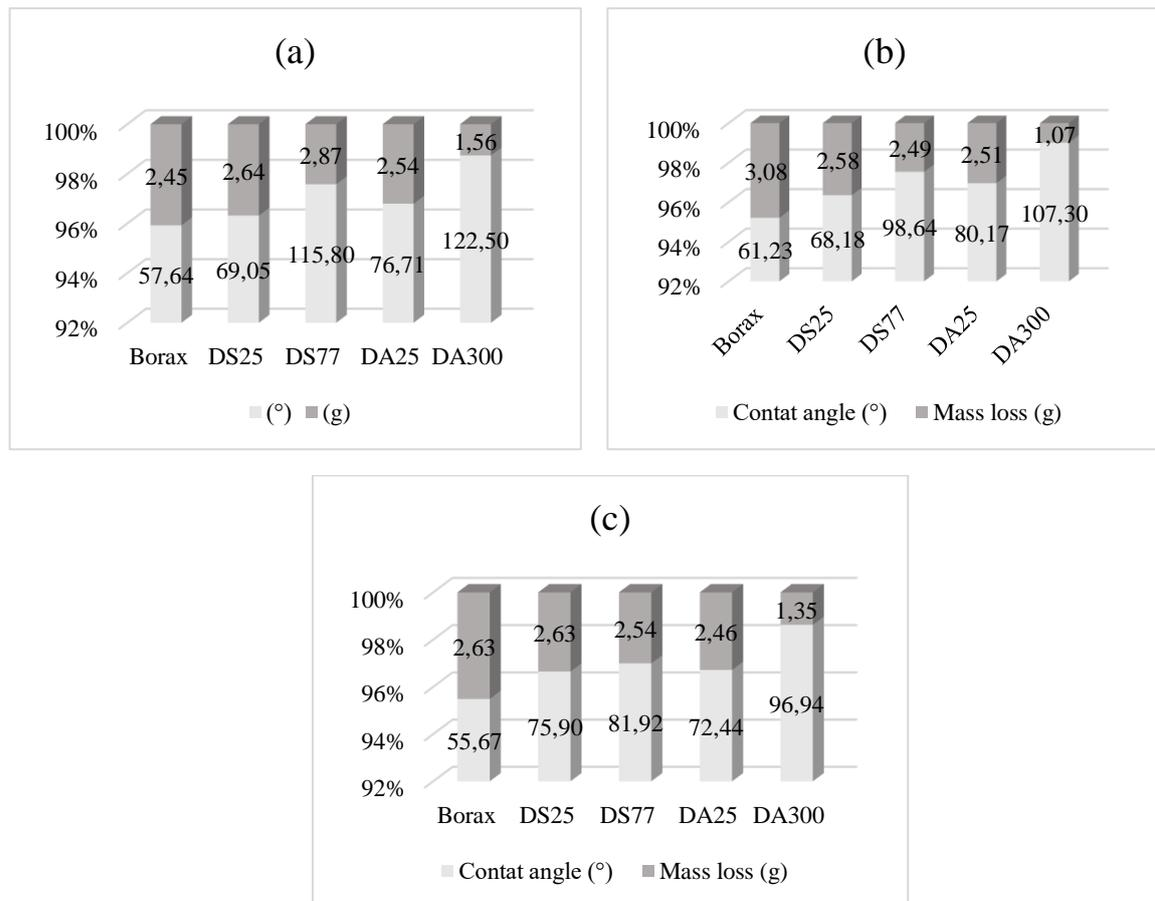
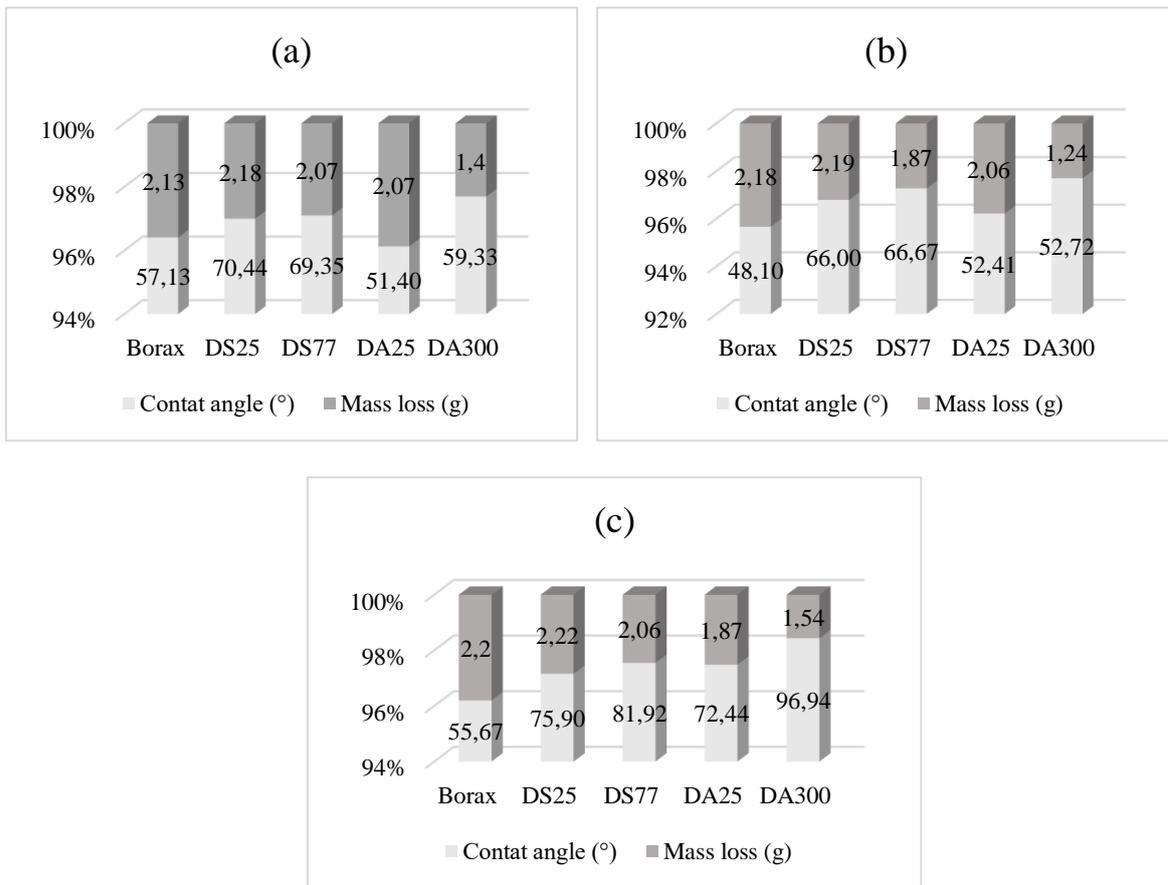


Figure I.2: Relation of mass loss (g) and contact angle (°) for poplar, (a) sawn, (b) Planed, (c) Sanded

## Appendix



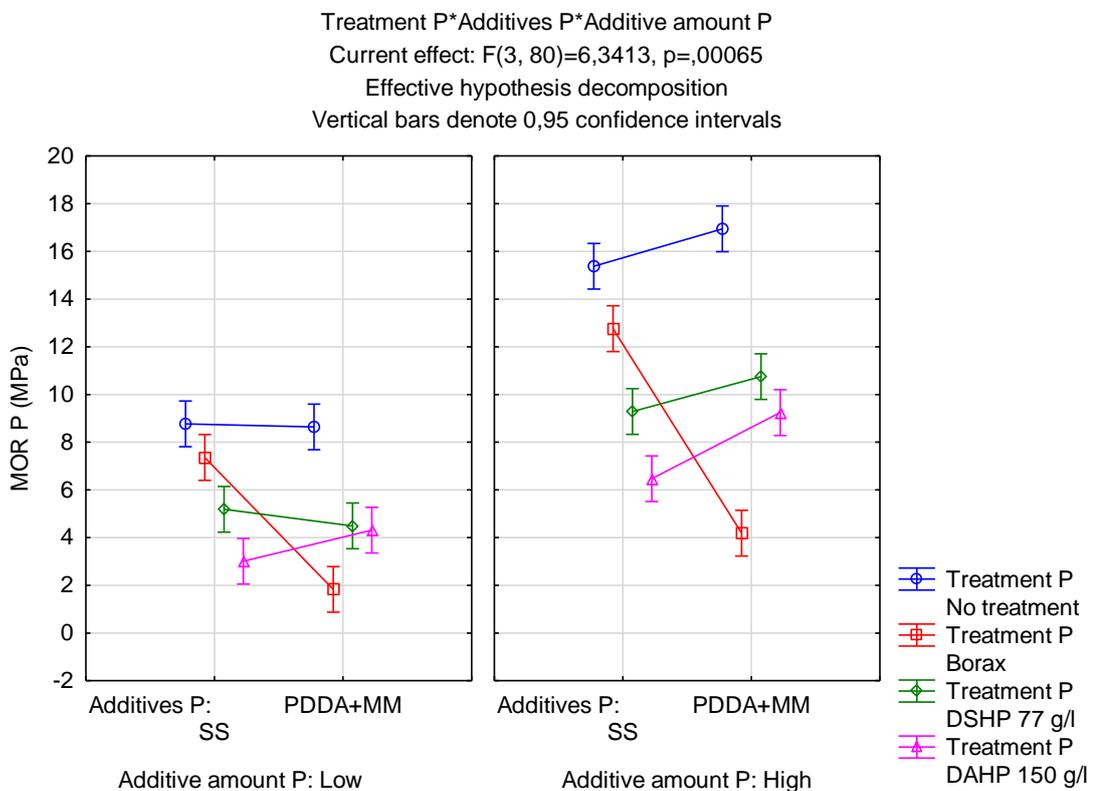
**Figure I.3:** Relation of mass loss (g) and contact angle (°) for Scots pine, (a) sawn, (b) Planed, (c) Sanded

- With hydration test, I proved that FR's and their concentrations have strong influence on the cement hydration. Based on the test results, PEG 400 is not suitable for CBPB production it doesn't allow cement to cure even after months of cement curing it shows no peaks of temperature while borax show same behaviour as control samples that indicate it has no effect on cement curing hydration process. However, for the other fire retardants slight prolongation of hydration time was caused to the cement mixture in case of FR's with low concentration the temperature peaks occur with delay of 3 hours for DAHP and 5 hours for DSHP. nevertheless, the temperature peak is lower with 2 °C of control sample. With increase in FR's concentration the peaks rise fast in the first 3 hours for DAHP and 1.5 hour for DSHP with temperature peak of 34 °C for DAHP while similar to control specimens for DSHP with temperature 28 °C. [\[FZB-JP-4\]](#), [\[FZB-CP-4\]](#)
- Based on standard test EN 310, EN 317 and EN 319 for physical and mechanical properties of CBPB's, I proved that fire retardants at high concentration with DSHP 77 g/l and DAHP 150 g/l have significant negative effect on the properties of the CBPB and are significantly influenced by the type of additives and kind of treatment in the case of both the Scots pine and

## Appendix

poplar-based panels, with the exception of the thickness swelling of panels that made of Scots pine particles. However, with increase in the additive amount from 0.2 % to 20 % in case of PDDA+MM and from 2 % to 5 % for SS, the properties improve as well. Most of good properties achieved on poplar with DAHP 150 g/l. As example: TS on poplar DAHP 150 g/l decreased the TS to 0.68% with SS and 0.77% with PDDA+MM. [\[FZB-CP-6\]](#), [\[FZB-CP-7\]](#), [\[FZB-JP-5\]](#).

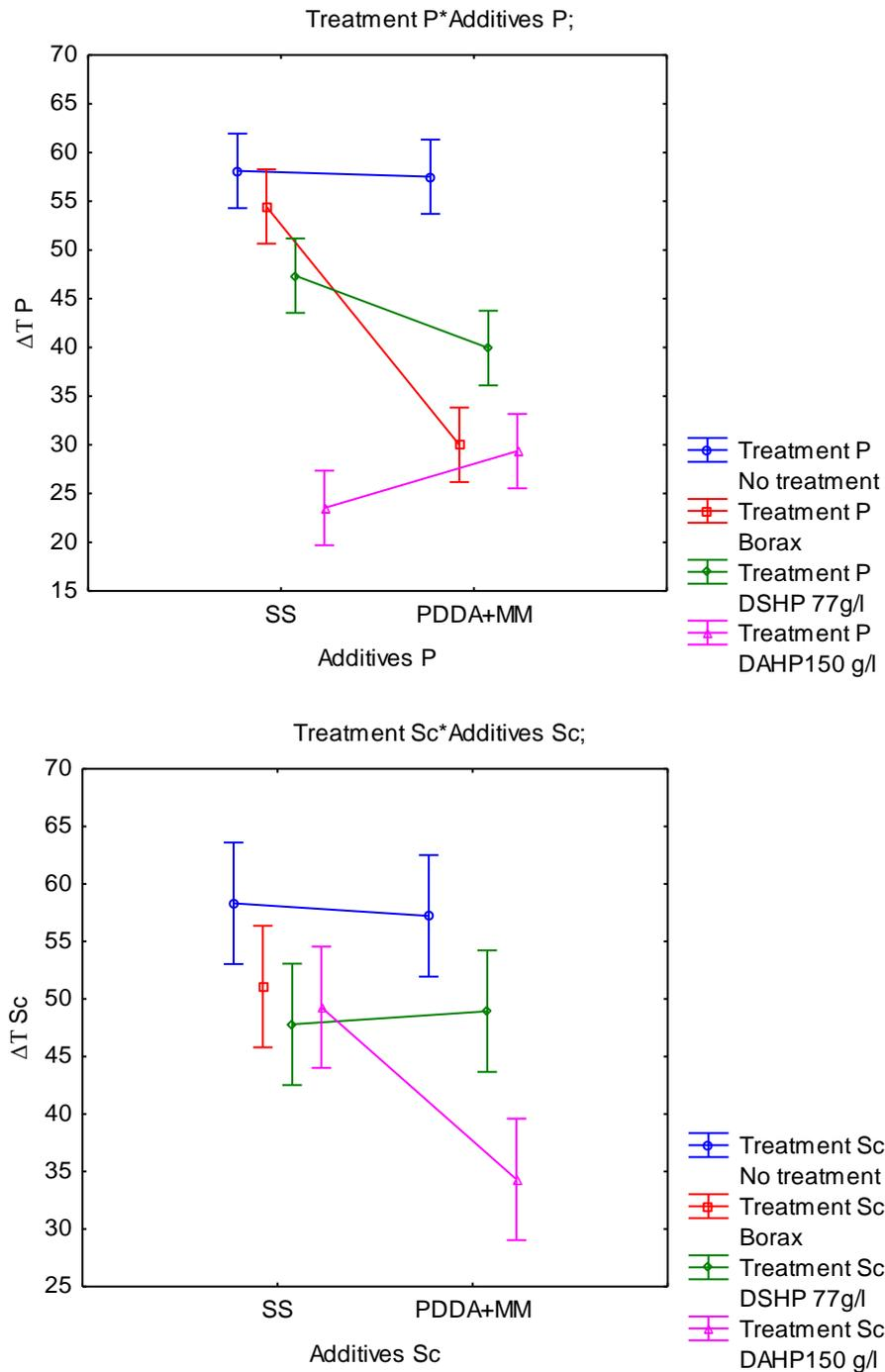
5. I proved that interaction between additive and treatment has strong effect. SS with 5% of cement weight is effective with borax and DSHP and not effective with DAHP, while PDDA+MM with 20% of cement weight is effective with DSHP and DAHP and have no effect with borax, as example see Figure I.4 that represents interaction of factors for MOR of poplar. [\[FZB-CP-6\]](#), [\[FZB-CP-7\]](#), [\[FZB-JP-5\]](#).



**Figure I.4:** Interaction diagram of Treatment \* Additives \* Additive amount of MOR poplar.

6. I proved That fire retardants have no significant effect on the fire resistance of scots pine based CBPB except for DAHP 150 g/l with PDDA+MM while has a significant effect on poplar based CBPB. The used additive showed significant effect in both cases Scots pine and poplar based CBPB. The interaction of treatment and additive not significant in case of scots pine while significant in case of poplar based CBPB. Interaction of treatments with PDDA+MM has better effect on fire resistance of the CBPB than of SS (Fig.I.5). [\[FZB-CP-6\]](#), [\[FZB-CP-5\]](#).

## Appendix



**Figure I.5:** Interaction diagram of Pre-Treatment\*Additive for  $\Delta T$ , (P) poplar CBPB, (Sc) Scot's pine CBPB.

7. I proved that the fire retardants pre-treatments for wood particles used in CBPB production are effective treatments to increase the fire resistance of wood. It could state that DAHP 150 g/l has advantage on not only increasing fire resistance of CBPB's but upgrading the fire classification of poplar based CBPB from B-s1, d0 to A<sub>1</sub> with 5 % of SS as an additive or with 20 % of PDDA+MM covered with SS. (Fig.I.6) represent one of the measurements of sample

## Appendix

P-DA-SS-5 %, which prove that  $\Delta T$  is lower than 30 °C that make it within the standard requirement of A<sub>1</sub> classification. [\[FZB-CP-6\]](#), [\[FZB-JP-5\]](#).

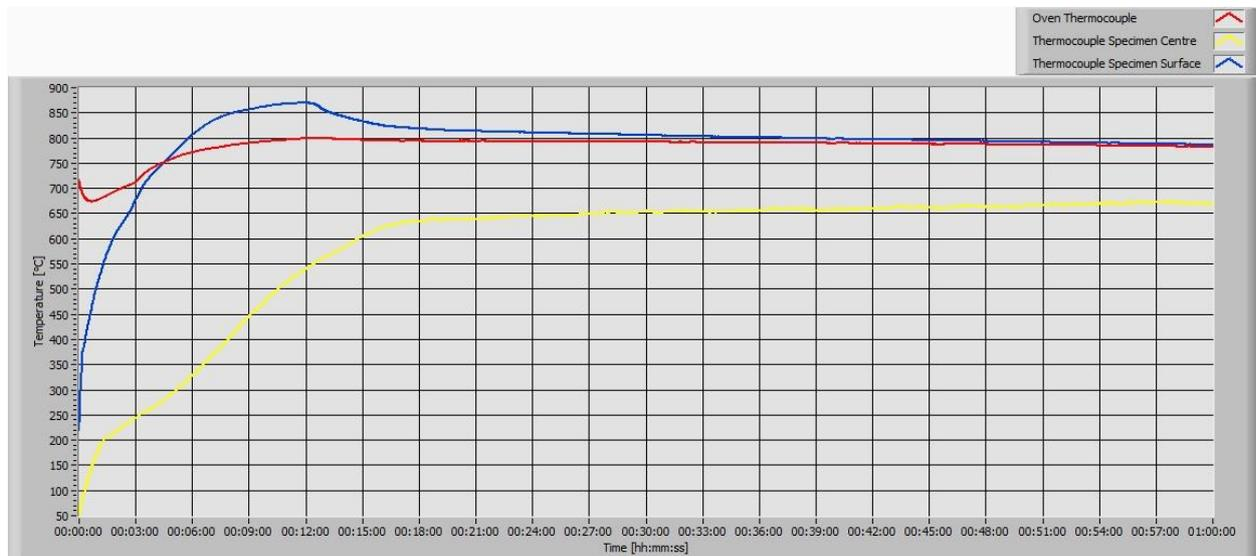


Figure I.6: Non combustibility test temperature curve

- Using fire retardants in CBPB leads to a hypothesis where new crystalline phases in cement wood mixture may occur, and that crystalline phases might be the reason of fire retardants influence on cement curing. Using XRD and SEM images I proved that the hypothesis is wrong and no new crystalline phases were occurred only the usual crystalline phases in cement wood mixture appeared like Alite, Portlandite, Calcite, Ferrite and Ettringite. The reason of effect of Fire retardants on cement hydration is the MC of the pre-treated particles which was higher than 30 %. That makes water in wood more than the mixing water which makes more wood inhibitors comes out [\[165\]](#). [\[FZB-JP-6\]](#).
- With DMA test I proved that temperature have negative influence on the CBPB's and high storage modulus is associated with high MOR and the inverse as well. For both wood species, poplar-based panels have higher loss modulus than of Scots pine-based panels that mean higher elasticity. [\[FZB-JP-6\]](#).

## Appendix

### My List of Publications

#### List of journal publications:

Brahmia, F. Z., Alpár, T., Horváth, P. G., & Csiha, C. (2020). Comparative analysis of wettability with fire retardants of Poplar (*Populus cv. euramericana I214*) and Scots pine (*Pinus sylvestris*). *Surfaces and Interfaces*, 18: [doi.org/10.1016/j.surfin.2019.100405](https://doi.org/10.1016/j.surfin.2019.100405) [FZB-JP-1]

Brahmia Fatima Zohra, Péter György Horváth, and Tibor L. Alpár. (2020)."Effect of Pre-Treatments and Additives on the Improvement of Cement Wood Composite: A Review." *BioResources* 15.3, pp 7288-7308. DOI: 10.15376/biores.15.3.Brahmia [FZB-JP-2]

Brahmia Fatima Zohra, Péter György Horváth, Tibor L. Alpár (2020). Flame retardancy of Scots pine (*Pinus sylvestris*) by using polyethylene glycol 400 and phosphoric acid. *International Journal of Psy. Reh*, 24(4), pp 507-515. DOI: 10.37200/IJPR/V24I4/PR201029 [FZB-JP-3]

Fatima Zohra Brahmia, Kovacs Zsolt, Péter György Horváth, Tibor L. Alpar. (2020) Comparative study on fire retardancy of various wood species by using PEG 400, phosphorus and boron compounds to use in cement-bonded wood-based products. *Surfaces and Interfaces*, 21: <https://doi.org/10.1016/j.surfin.2020.100736> [FZB-JP-4]

Fatima Zohra Brahmia, Kovacs Zsolt, Péter György Horváth, Tibor L. Alpar. Influence of fire retardants pre-treatments on mechanical and fire properties of cement bonded particle board. (Submitted). [FZB-JP-5]

Fatima Zohra Brahmia, Péter György Horváth, Janos Madarasz, Tibor L. Alpar. Thermal and mechanical characteristics of fire retardants pre-treated cement bonded particle board. (Submitted). [FZB-JP-6]

#### List of conference papers:

Brahmia Fatima Zohra, Péter György Horváth, Tibor L. Alpár. Improve fire resistance of scots pine (*pinus sylvestris*) by using fire retardant. Pécsi Tudományegyetem Doktorandusz Önkormányzat, pp 25. 17-19 May 2018. Pécs, Hungary. (Oral presentation) [FZB-CP-1]

Brahmia Fatima Zohra, Péter György Horváth, Tibor L. Alpár. Enhancing the fire resistance of poplar (*Populus cv. euramericana I214*) by using different fire retardants. The 8<sup>th</sup> Hardwood Conference- with special focus on new aspects of Hardwood utilization from science to technology. pp 118-119. 25-26 October 2018. Sopron Hungary. (Oral presentation) [FZB-CP-2]

## Appendix

Brahmia Fatima Zohra, Péter György Horváth, Tibor L. Alpár. Improve fire resistance of Date palm leaflet (*Phoenix dactylifera* L.). The 7th international scientific conference on advances in mechanical engineering. pp 223. 7-8 November 2019. Debrecen, Hungary. (Poster presentation) [\[FZB-CP-3\]](#)

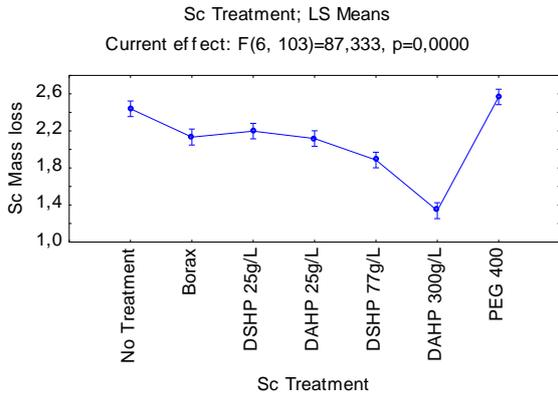
Brahmia Fatima Zohra, Péter György Horváth, Tibor L. Alpár. Enhancing performances of cement bonded wood-based products. The 6th international scientific conference on advances in mechanical engineering (ISCAME 2018) pp 25-26. 11-13 October 2018. Debrecen, Hungary. (Poster presentation) [\[FZB-CP-4\]](#)

Brahmia Fatima Zohra, Péter György Horváth, Tibor L. Alpár. Flame retardancy of Scots pine (*Pinus sylvestris*) by using polyethylene glycol 400 and phosphoric acid. International Conference on Researches in Science and Technology (ICRST-19). pp 48-53. 28<sup>th</sup> Octobre 2019. Vienna, Austria. (Oral presentation) [\[FZB-CP-5\]](#)

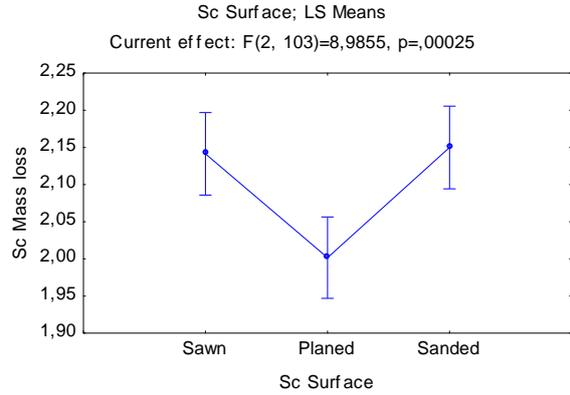
Brahmia Fatima Zohra, Péter György Horváth, Tibor L. Alpár. Enhancing the fire resistance of cement-bonded particleboard made of Scots pine and Poplar. Proceedings of the 2020 Society of Wood Science and Technology International Convention” Renewable Resources for a Sustainable and Healthy Future”. pp 459-468. July 12-15, 2020. PORTOROŽ, SLOVENIA (Poster presentation) [\[FZB-CP-6\]](#)

Brahmia Fatima Zohra, Péter György Horváth, Tibor L. Alpár. Effect of Fire retardants pre-treatments on the mechanical properties of Cement Bonded Particle Board made of Poplar hybrid I214. 9th Hardwood Conference. 9th Hardwood Proceedings: Part I. With Special Focus on "An Underutilized Resource: Hardwood Oriented Research" Sopron, Hungary (2020) 304 p. pp. 57-63. (Oral presentation) [\[FZB-CP-7\]](#)

# Appendix IV

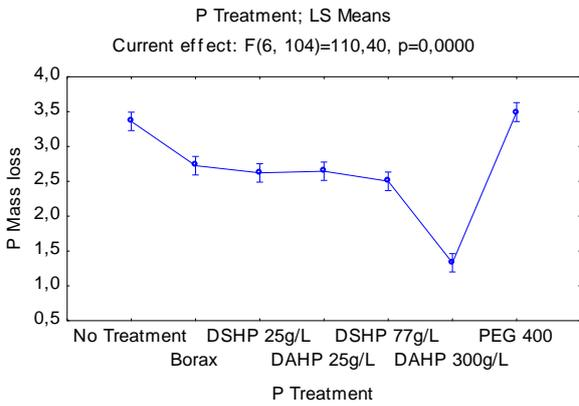


(a) Effect of treatment

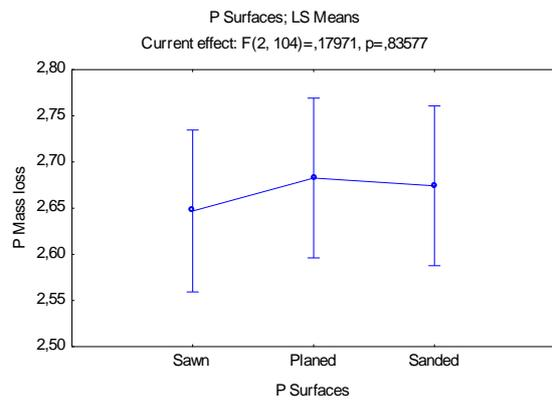


(b) Effect of surface

Fig IV.1: Effects diagrams of the different treatments and surface preparations for Mass loss of Scots pine.

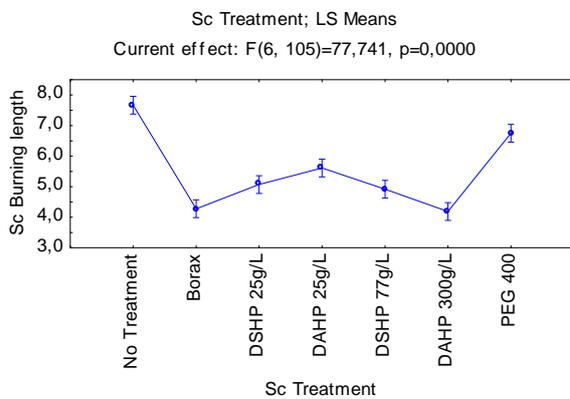


(a) Effect of treatment

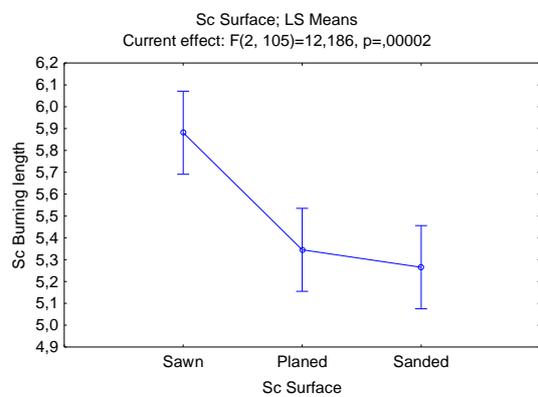


(b) Effect of surface

Fig IV.2: Effects diagrams of the different treatments and surface preparations for Mass loss of poplar.



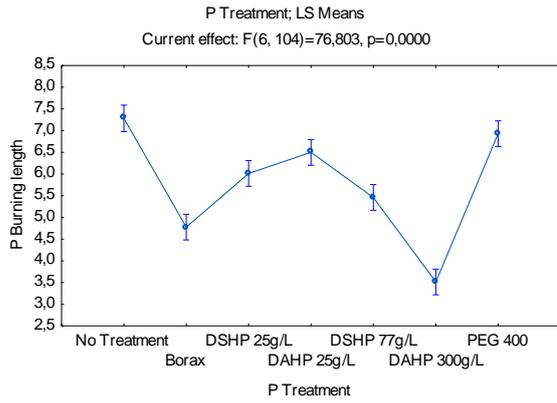
(a) Effect of treatment



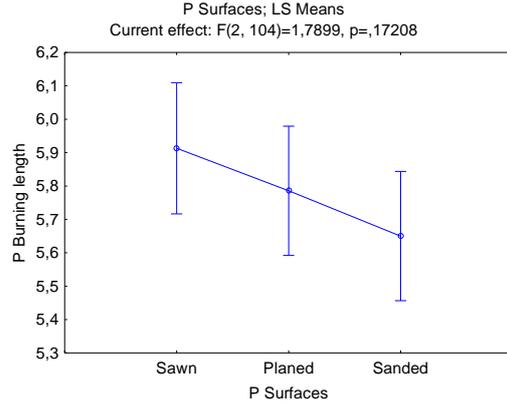
(b) Effect of surface

Fig IV.3: Effects diagrams of the different treatments and surface preparations for Burning length of Scots pine.

## Appendix IV

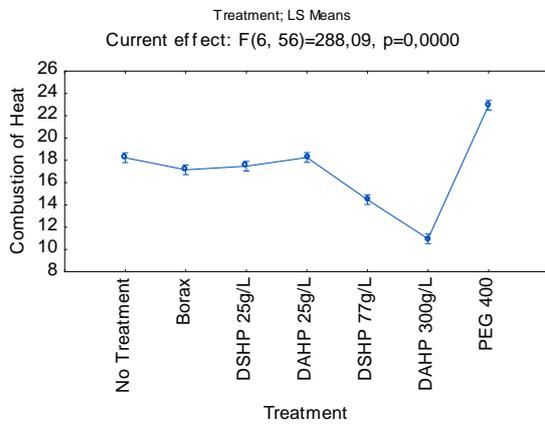


(a) Effect of treatment

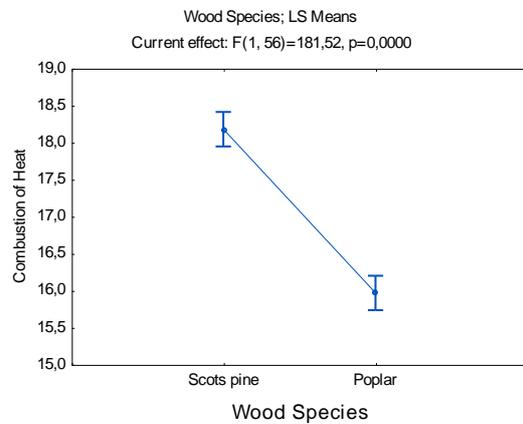


(b) Effect of surface

Fig IV.4: Effects diagrams of the different treatments and surface preparations for Burning length of poplar.



(a) Effect of treatment



(b) Effect of Wood species

Fig IV.5: Effects diagrams of the different treatments and wood species for combustion heat.

### 1. Mechanical properties statistical analysis:

Table IV.1: SS Whole Model Vs. SS Residual for Main ANOVA

main anova	Multiple R	Multiple R <sup>2</sup>	Adjusted R <sup>2</sup>	SS Model	df Model	MS Model	SS Residual	df Residual	MS Residual	F	p
MOR Sc	0.815426	0.664920	0.644975	440.8120	5	88.16240	222.1429	84	2.644558	33.33729	0.00
Density Sc	0.705526	0.497767	0.467872	353060.2	5	70612.05	356228.4	84	4240.814	16.65059	0.000000
IBS Sc	0.612213	0.374805	0.337591	1.191223	5	0.238245	1.987025	84	0.023655	10.07161	0.000000
TS Sc	0.307722	0.094693	0.040805	59.44901	5	11.88980	568.3605	84	6.766197	1.757236	0.130590
MOR P	0.853484	0.728436	0.713349	1317.532	5	263.5064	491.1824	90	5.457583	48.28263	0.00
Density P	0.730201	0.533193	0.507259	666504.8	5	133301.0	583521.1	90	6483.568	20.55982	0.000000
IBS P	0.896469	0.803657	0.792749	3.113647	5	0.622729	0.760702	90	0.008452	73.67621	0.00
TS P	0.743652	0.553019	0.528186	201.5338	5	40.30676	162.8912	90	1.809902	22.27013	0.000000

## Appendix IV

Table IV.2: SS Whole Model vs. SS Residual for Nested ANOVA

nest ed anov a	Multip le R	Multip le R <sup>2</sup>	Adjust ed R <sup>2</sup>	SS Model	df Mod el	MS Model	SS Residu al	df Resid ual	MS Residu al	F	p
MOR Sc	0.8241 31	0.6791 92	0.6560 01	450.27 36	6	75.045 60	212.68 13	83	2.5624 26	29.286 94	0.00
Densi ty Sc	0.7055 26	0.4977 67	0.4614 61	35306 0.7	6	58843. 46	35622 7.9	83	4291.9 03	13.710 34	0.0000 00
IBS Sc	0.6933 68	0.4807 60	0.4432 24	1.5279 74	6	0.2546 62	1.6502 75	83	0.0198 83	12.808 15	0.0000 00
TS Sc	0.5336 47	0.2847 79	0.2330 76	178.78 67	6	29.797 79	449.02 28	83	5.4099 14	5.5079 97	0.0000 77
MOR P	0.8541 17	0.7295 15	0.7112 80	1319.4 85	6	219.91 42	489.22 96	89	5.4969 62	40.006 49	0.00
Densi ty P	0.7401 47	0.5478 17	0.5173 33	68478 5.7	6	11413 0.9	56524 0.3	89	6351.0 14	17.970 51	0.0000 00
IBS P	0.8993 62	0.8088 51	0.7959 65	3.1337 73	6	0.5222 95	0.7405 76	89	0.0083 21	62.767 76	0.00
TS P	0.7881 28	0.6211 45	0.5956 04	226.36 08	6	37.726 80	138.06 42	89	1.5512 83	24.319 74	0.0000 00

Table IV.3: SS Whole Model vs. SS Residual for Factorial ANOVA

neste d anov a	Multip le R	Multip le R <sup>2</sup>	Adjust ed R <sup>2</sup>	SS Model	df Mod el	MS Model	SS Residu al	df Resid ual	MS Residu al	F	p
MOR Sc	0.9632 11	0.9277 75	0.9142 93	615.07 32	14	43.933 80	47.881 72	75	0.6384 23	68.816 13	0.00
Densi ty Sc	0.8856 86	0.7844 39	0.7442 01	55639 3.8	14	39742. 41	15289 4.9	75	2038.5 98	19.494 97	0.00
IBS Sc	0.9746 71	0.9499 83	0.9406 46	3.0192 82	14	0.2156 63	0.1589 67	75	0.0021 20	101.74 92	0.00
TS Sc	0.8349 97	0.6972 20	0.6407 01	437.72 15	14	31.265 82	190.08 80	75	2.5345 07	12.336 06	0.0000 00
MOR P	0.9687 63	0.9385 01	0.9269 70	1697.4 81	15	113.16 54	111.23 39	80	1.3904 24	81.389 13	0.00
Densi ty P	0.8847 14	0.7827 18	0.7419 78	97841 8.2	15	65227. 88	27160 7.7	80	3395.0 97	19.212 38	0.00
IBS P	0.9727 93	0.9463 26	0.9362 63	3.6663 99	15	0.2444 27	0.2079 50	80	0.0025 99	94.032 83	0.00
TS P	0.8343 40	0.6961 24	0.6391 47	253.68 50	15	16.912 33	110.74 00	80	1.3842 50	12.217 69	0.0000 00

## Appendix IV

Table IV.4: Homogeneity of variances for Main ANOVA.

		Levene's Test for Homogeneity of Variances				Tests of Homogeneity of Variances				
main anova	Factors	MS Effect	MS Error	F	P	Hartley F-max	Cochran C	Bartlett Chi-Sqr.	d f	P
MOR Sc	Treatment	6.7875 95	1.1526 63	5.8886 23	0.0010 52	2.6950 19	0.3526 34	5.8648 85	3	0.1183 72
	Additives	4.9793 42	2.0937 20	2.3782 28	0.1266 26	1.2580 41	0.5571 38	0.5721 66	1	0.4494 00
	Concentration	1.3208 13	1.5552 63	0.8492 54	0.3592 83	1.2479 24	0.5551 45	0.5326 05	1	0.4655 14
Density Sc	Treatment	8132.9 76	2041.4 09	3.9840 00	0.0104 23	4.0004 04	0.3819 15	11.051 54	3	0.0114 50
	Additives	1526.6 41	2540.9 82	0.6008 07	0.4403 48	1.0074 57	0.5018 57	0.0005 98	1	0.9804 97
	Concentration	2188.0 98	2558.1 05	0.8553 59	0.3575 70	1.0993 43	0.5236 60	0.0972 79	1	0.7551 20
IBS Sc	Treatment	0.0203 17	0.0054 45	3.7313 30	0.0142 06	2.1953 62	0.3438 58	3.4553 52	3	0.3265 99
	Additives	0.0269 17	0.0050 70	5.3094 72	0.0235 65	1.2878 64	0.5629 11	0.6949 64	1	0.4044 81
	Concentration	0.0048 14	0.0100 24	0.4802 81	0.4901 20	1.5293 99	0.6046 49	1.9583 43	1	0.1616 91
TS Sc	Treatment	2.9564 34	2.3109 14	1.2793 35	0.2866 34	1.7539 07	0.3216 17	2.3725 27	3	0.4987 69
	Additives	4.3294 35	2.5106 60	1.7244 21	0.1925 39	1.2302 06	0.5516 11	0.4660 19	1	0.4948 24
	Concentration	0.0189 58	2.3756 07	0.0079 80	0.9290 20	1.0125 93	0.5031 28	0.0016 95	1	0.9671 63
MOR P	Treatment	12.449 37	2.4214 93	5.1411 97	0.0024 82	2.7822 88	0.3644 87	7.3929 92	3	0.0603 73
	Additives	17.091 14	6.1209 10	2.7922 55	0.0980 47	1.4857 23	0.5977 03	1.8105 05	1	0.1784 48
	Concentration	47.022 91	3.4797 51	13.513 30	0.0003 94	2.7348 56	0.7322 52	11.302 89	1	0.0007 74
Density P	Treatment	6452.9 06	2497.9 39	2.5832 92	0.0580 57	2.8546 13	0.3198 71	6.7991 43	3	0.0785 83
	Additives	4207.1 59	4364.7 09	0.9639 04	0.3287 26	1.3798 38	0.5798 03	1.2000 41	1	0.2733 14
	Concentration	6845.7 70	3341.4 20	2.0487 61	0.1556 47	1.6258 15	0.6191 66	2.7195 82	1	0.0991 24
IBS P	Treatment	0.0338 55	0.0080 81	4.1894 49	0.0079 38	2.1265 32	0.3389 26	3.3330 89	3	0.3430 64
	Additives	0.0180 24	0.0092 82	1.9418 27	0.1667 56	1.2351 44	0.5526 02	0.5175 77	1	0.4718 77
	Concentration	0.0068 20	0.0041 74	1.3402 9	0.2042 94	1.4815 48	0.5970 26	1.7850 24	1	0.1815 34
TS P	Treatment	2.9291 36	1.2923 82	2.2664 62	0.0859 85	3.5299 44	0.3909 97	10.372 04	3	0.0156 55
	Additives	8.4115 31	1.5207 24	5.5312 68	0.0207 67	2.6166 58	0.7235 02	10.366 42	1	0.0012 83
	Concentration	7.2889 04	1.0476 65	6.9572 87	0.0097 69	2.8286 12	0.7388 09	12.041 34	1	0.0005 20

## Appendix IV

Table IV.5: Homogeneity of variances for Nested ANOVA.

nested	Factors	Levene's Test for Homogeneity of Variances				Tests of Homogeneity of Variances				
		MS Effect	MS Error	F	P	Hartley F-max	Cochran C	Bartlett Chi-Sqr.	d f	P
MOR Sc	Treatment	6.7875 95	1.1526 63	5.8886 23	0.0010 52	2.6950 19	0.3526 34	5.8648 85	3	0.1183 72
	Additives	4.9793 42	2.0937 20	2.3782 28	0.1266 26	1.2580 41	0.5571 38	0.5721 66	1	0.4494 00
	Concentration	2.4814 55	1.0227 42	2.4262 75	0.0710 33	2.4003 39	0.3416 22	5.9176 03	3	0.1156 89
Density Sc	Treatment	8132.9 76	2041.4 09	3.9840 00	0.0104 23	4.0004 04	0.3819 15	11.051 54	3	0.0114 50
	Additives	1526.6 41	2540.9 82	0.6008 07	0.4403 48	1.0074 57	0.5018 57	0.0005 98	1	0.9804 97
	Concentration	4364.2 13	2079.4 78	2.0987 06	0.1063 21	2.4586 08	0.3401 19	5.1705 34	3	0.1597 27
IBS Sc	Treatment	0.0203 17	0.0054 45	3.7313 30	0.0142 06	2.1953 62	0.3438 58	3.4553 52	3	0.3265 99
	Additives	0.0269 17	0.0050 70	5.3094 72	0.0235 65	1.2878 64	0.5629 11	0.6949 64	1	0.4044 81
	Concentration	0.0358 11	0.0066 91	5.3522 43	0.0019 91	10.903 25	0.4087 04	20.805 49	3	0.0001 16
TS Sc	Treatment	2.9564 34	2.3109 14	1.2793 35	0.2866 34	1.7539 07	0.3216 17	2.3725 27	3	0.4987 69
	Additives	4.3294 35	2.5106 60	1.7244 21	0.1925 39	1.2302 06	0.5516 11	0.4660 19	1	0.4948 24
	Concentration	9.4493 72	1.9957 88	4.7346 57	0.0041 82	5.8553 74	0.3707 84	16.440 81	3	0.0009 21
MOR P	Treatment	12.449 37	2.4214 93	5.1411 97	0.0024 82	2.7822 88	0.3644 87	7.3929 92	3	0.0603 73
	Additives	17.091 14	6.1209 10	2.7922 55	0.0980 47	1.4857 23	0.5977 03	1.8105 05	1	0.1784 48
	Concentration	21.625 17	3.6921 84	5.8570 12	0.0010 49	4.1605 92	0.4805 78	14.456 27	3	0.0023 46
Density P	Treatment	6452.9 06	2497.9 39	2.5832 92	0.0580 57	2.8546 13	0.3198 71	6.7991 43	3	0.0785 83
	Additives	4207.1 59	4364.7 09	0.9639 04	0.3287 26	1.3798 38	0.5798 03	1.2000 41	1	0.2733 14
	Concentration	11264. 64	3129.0 94	3.5999 69	0.0164 33	4.4164 94	0.4248 78	12.044 87	3	0.0072 31
IBS P	Treatment	0.0338 55	0.0080 81	4.1894 49	0.0079 38	2.1265 32	0.3389 26	3.3330 89	3	0.3430 64
	Additives	0.0180 24	0.0092 82	1.9418 27	0.1667 56	1.2351 44	0.5526 02	0.5175 77	1	0.4718 77
	Concentration	0.0074 15	0.0032 01	2.3161 96	0.0808 52	2.6147 21	0.3954 01	7.8850 27	3	0.0484 49
TS P	Treatment	2.9291 36	1.2923 82	2.2664 62	0.0859 85	3.5299 44	0.3909 97	10.372 04	3	0.0156 55
	Additives	8.4115 31	1.5207 24	5.5312 68	0.0207 67	2.6166 58	0.7235 02	10.366 42	1	0.0012 83
	Concentration	3.0868 53	0.8236 53	3.7477 59	0.0136 86	3.4197 82	0.4921 28	12.469 74	3	0.0059 36

## Appendix IV

Table IV.6: Homogeneity of variances for Factoriel ANOVA.

		Levene's Test for Homogeneity of Variances				Tests of Homogeneity of Variances				
fa anova	Factor s	MS Effect	MS Error	F	P	Hartley F-max	Cochran C	Bartlett Chi-Sqr.	df	P
MOR Sc	A	6.78759 5	1.15266 3	5.88862 3	0.00105 2	2.69501 9	0.35263 4	5.86488 5	3	0.11837 2
	B	4.97934 2	2.09372 0	2.37822 8	0.12662 6	1.25804 1	0.55713 8	0.57216 6	1	0.44940 0
	C	1.32081 3	1.55526 3	0.84925 4	0.35928 3	1.24792 4	0.55514 5	0.53260 5	1	0.46551 4
	AB	8.71003 6	0.51068 3	17.0556 5	0.00000 0	12.3267 2	0.27131 9	21.6935 0	7	0.00286 9
	AC	6.23815 4	0.42519 2	14.6713 9	0.00000 0	19.6417 9	0.45107 8	38.8347 8	7	0.00000 2
	BC	2.48145 5	1.02274 2	2.42627 5	0.07103 3	2.40033 9	0.34162 2	5.91760 3	3	0.11568 9
	ABC	0.34661 3	0.19856 1	1.74562 9	0.06396 6	31.2475 4	0.17645 8	23.0909 7	1 4	0.05880 5
Density Sc	A	8132.97 6	2041.40 9	3.98400 0	0.01042 3	4.00040 4	0.38191 5	11.0515 4	3	0.01145 0
	B	1526.64 1	2540.98 2	0.60080 7	0.44034 8	1.00745 7	0.50185 7	0.00059 8	1	0.98049 7
	C	2188.09 8	2558.10 5	0.85535 9	0.35757 0	1.09934 3	0.52366 0	0.09727 9	1	0.75512 0
	AB	5862.06 3	1226.70 8	4.77869 5	0.00015 2	6.91002 3	0.27728 0	16.0845 4	7	0.02435 5
	AC	4627.89 9	1108.85 5	4.17358 5	0.00056 4	9.17804 0	0.34087 9	18.5067 0	7	0.00988 1
	BC	4364.21 3	2079.47 8	2.09870 6	0.10632 1	2.45860 8	0.34011 9	5.17053 4	3	0.15972 7
	ABC	674.029 0	655.281 4	1.02861 0	0.43536 5	13.2215 6	0.18232 2	14.5978 7	1 4	0.40618 4
IBS Sc	A	0.02031 7	0.00544 5	3.73133 0	0.01420 6	2.19536 2	0.34385 8	3.45535 2	3	0.32659 9
	B	0.02691 7	0.00507 0	5.30947 2	0.02356 5	1.28786 4	0.56291 1	0.69496 4	1	0.40448 1
	C	0.00481 4	0.01002 4	0.48028 1	0.49012 0	1.52939 9	0.60464 9	1.95834 3	1	0.16169 1
	AB	0.04182 2	0.00189 1	22.1180 7	0.00000 0	36.8369 2	0.23456 6	21.5503 4	7	0.00303 6
	AC	0.08082 3	0.00174 4	46.3466 2	0.00 0	100.056 2	0.42853 8	63.2595 4	7	0.00000 0
	BC	0.03581 1	0.00669 1	5.35224 3	0.00199 1	10.9032 5	0.40870 4	20.8054 9	3	0.00011 6
	ABC	0.00185 5	0.00063 1	2.94001 1	0.00132 8	88.0000 0	0.22143 0	39.8922 9	1 4	0.00026 5
TS Sc	A	2.95643 4	2.31091 4	1.27933 5	0.28663 4	1.75390 7	0.32161 7	2.37252 7	3	0.49876 9
	B	4.32943 5	2.51066 0	1.72442 1	0.19253 9	1.23020 6	0.55161 1	0.46601 9	1	0.49482 4
	C	0.01895 8	2.37560 7	0.00798 0	0.92902 0	1.01259 3	0.50312 8	0.00169 5	1	0.96716 3
	AB	12.3415 4	1.13352 2	10.8877 8	0.00000 0	20.7640 2	0.32598 3	33.9790 8	7	0.00001 7
	AC	6.63466 4	1.39931 6	4.74136 2	0.00016 5	135.678 6	0.24806 2	26.7557 0	7	0.00036 9
	BC	9.44937 2	1.99578 8	4.73465 7	0.00418 2	5.85537 4	0.37078 4	16.4408 1	3	0.00092 1

## Appendix IV

	ABC	2.70861 4	0.74085 2	3.65608 0	0.00012 6	150.202 3	0.21862 8	54.6394 6	1 4	0.00000 1
MOR P	A	12.4493 7	2.42149 3	5.14119 7	0.00248 2	2.78228 8	0.36448 7	7.39299 2	3	0.06037 3
	B	17.0911 4	6.12091 0	2.79225 5	0.09804 7	1.48572 3	0.59770 3	1.81050 5	1	0.17844 8
	C	47.0229 1	3.47975 1	13.5133 0	0.00039 4	2.73485 6	0.73225 2	11.3028 9	1	0.00077 4
	AB	10.2167 4	0.98193 1	10.4047 4	0.00000 0	8.92887 1	0.27268 4	16.9385 6	7	0.01779 7
	AC	18.1121 5	0.72554 4	24.9635 4	0.00 0	28.6673 4	0.50126 5	52.0033 1	7	0.00000 0
	BC	21.6251 7	3.69218 4	5.85701 2	0.00104 9	4.16059 2	0.48057 8	14.4562 7	3	0.00234 6
	ABC	1.07786 4	0.33421 0	3.22510 7	0.00035 1	111.455 8	0.29934 5	33.1092 0	1 5	0.00453 3
	Densit y P	A	6452.90 6	2497.93 9	2.58329 2	0.05805 7	2.85461 3	0.31987 1	6.79914 3	3
B		4207.15 9	4364.70 9	0.96390 4	0.32872 6	1.37983 8	0.57980 3	1.20004 1	1	0.27331 4
C		6845.77 0	3341.42 0	2.04876 1	0.15564 7	1.62581 5	0.61916 6	2.71958 2	1	0.09912 4
AB		11233.8 5	1847.17 7	6.08163 1	0.00000 8	5.72644 3	0.28453 4	17.8432 4	7	0.01269 8
AC		6227.03 3	1938.37 8	3.21249 6	0.00444 6	7.59180 0	0.29648 6	15.3751 3	7	0.03148 0
BC		11264.6 4	3129.09 4	3.59996 9	0.01643 3	4.41649 4	0.42487 8	12.0448 7	3	0.00723 1
ABC		1682.46 8	1050.26 9	1.60194 0	0.09178 2	48.0019 4	0.22286 8	25.9248 1	1 5	0.03882 0
IBS P	A	0.03385 5	0.00808 1	4.18944 9	0.00793 8	2.12653 2	0.33892 6	3.33308 9	3	0.34306 4
	B	0.01802 4	0.00928 2	1.94182 7	0.16675 6	1.23514 4	0.55260 2	0.51757 7	1	0.47187 7
	C	0.00682 0	0.00417 4	1.63402 9	0.20429 4	1.48154 8	0.59702 6	1.78502 4	1	0.18153 4
	AB	0.04226 7	0.00223 6	18.9053 3	0.00000 0	5.61717 7	0.21583 9	16.7670 7	7	0.01896 1
	AC	0.02510 4	0.00126 6	19.8221 9	0.00000 0	13.7089 5	0.31778 4	40.1971 0	7	0.00000 1
	BC	0.00741 5	0.00320 1	2.31619 6	0.08085 2	2.61472 1	0.39540 1	7.88502 7	3	0.04844 9
	ABC	0.00221 6	0.00072 6	3.05420 7	0.00064 0	25.7433 6	0.23314 9	33.8128 5	1 5	0.00361 7
TS P	A	2.92913 6	1.29238 2	2.26646 2	0.08598 5	3.52994 4	0.39099 7	10.3720 4	3	0.01565 5
	B	8.41153 1	1.52072 4	5.53126 8	0.02076 7	2.61665 8	0.72350 2	10.3664 2	1	0.00128 3
	C	7.28890 4	1.04766 5	6.95728 7	0.00976 9	2.82861 2	0.73880 9	12.0413 4	1	0.00052 0
	AB	4.75259 4	0.91431 6	5.19797 8	0.00005 5	11.4075 6	0.36800 3	33.5071 3	7	0.00002 1
	AC	2.61700 9	0.71511 6	3.65955 8	0.00163 5	29.8555 3	0.33578 7	44.5801 9	7	0.00000 0
	BC	3.08685 3	0.82365 3	3.74775 9	0.01368 6	3.41978 2	0.49212 8	12.4697 4	3	0.00593 6
	ABC	1.40475 1	0.51202 8	2.74350 4	0.00191 3	122.765 2	0.34743 2	63.7398 9	1 5	0.00000 0

# Appendix IV

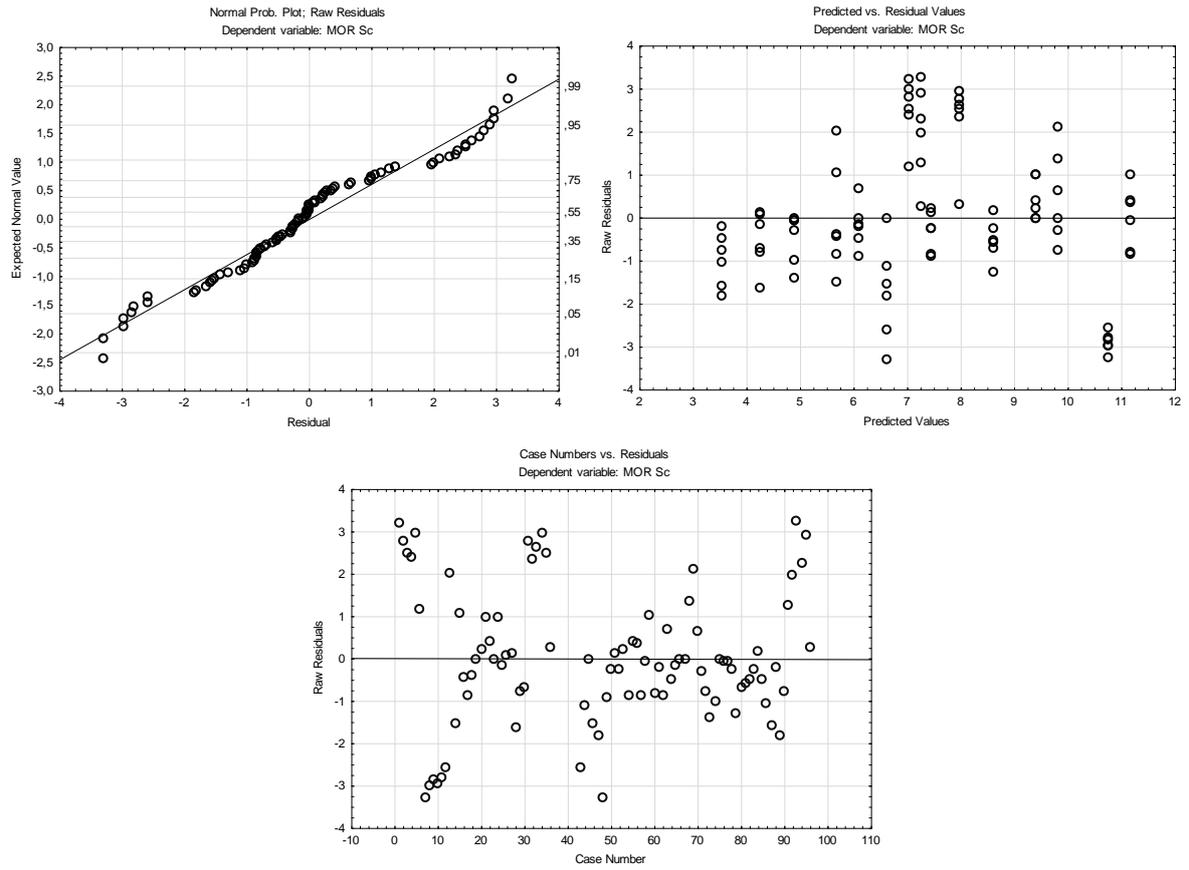


Figure IV.6: The normality of the distribution of residuals for MOR Sc of Main ANOVA

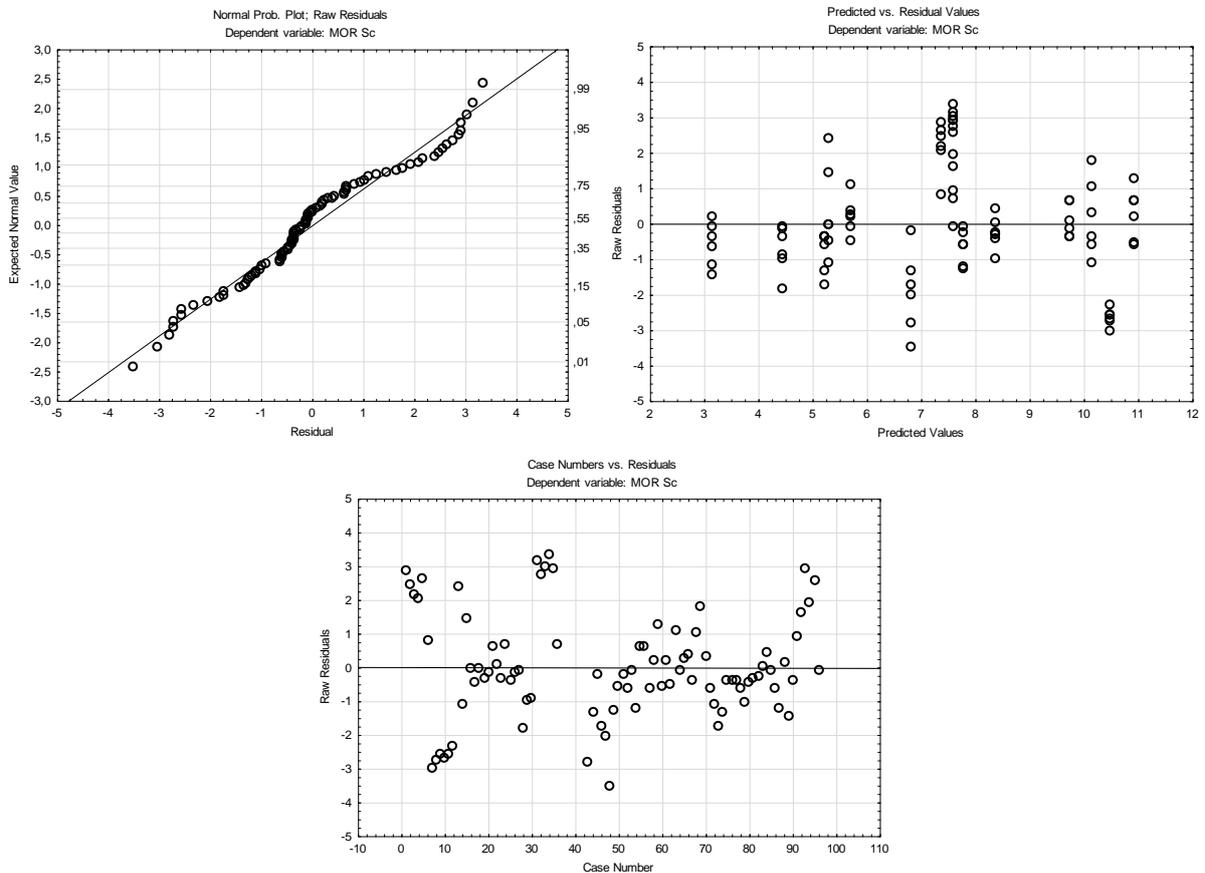


Figure IV.7: The normality of the distribution of residuals for MOR Sc of Nested ANOVA

# Appendix IV

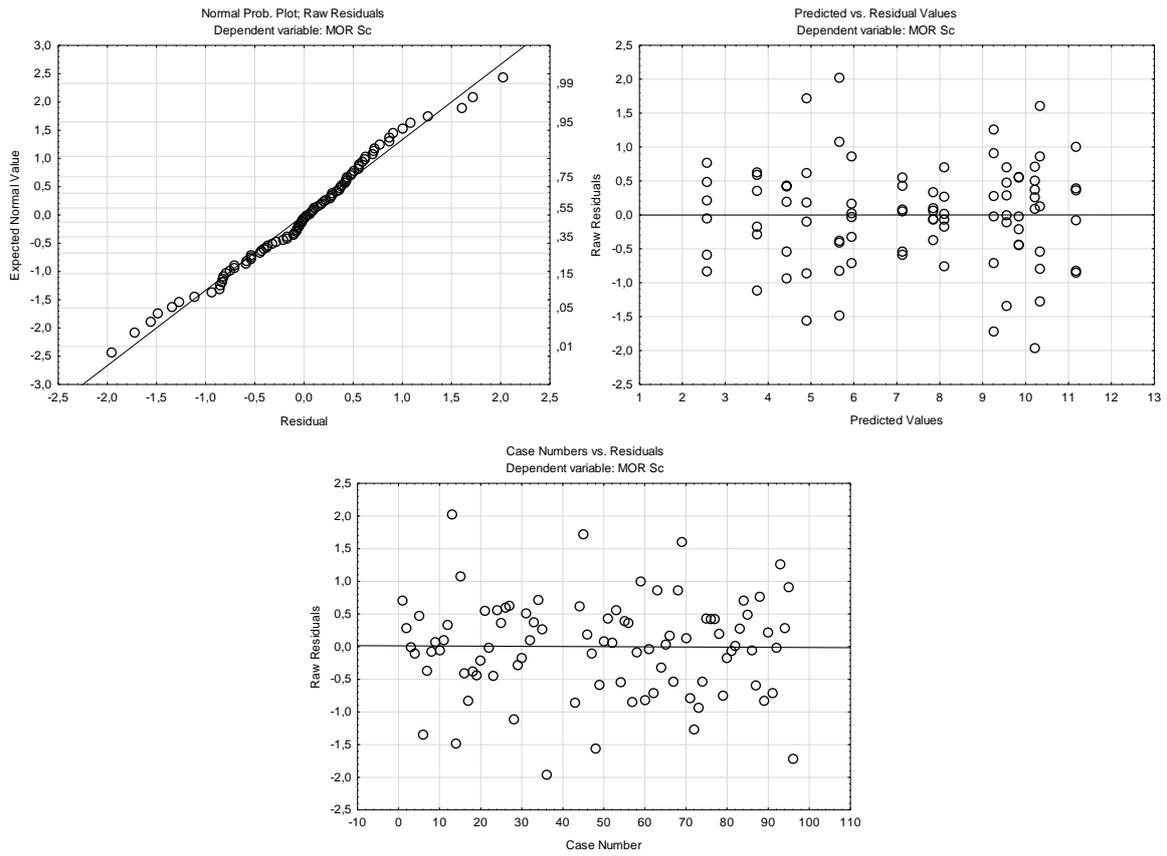


Figure IV.8: The normality of the distribution of residuals for MOR Sc of Factorial ANOVA

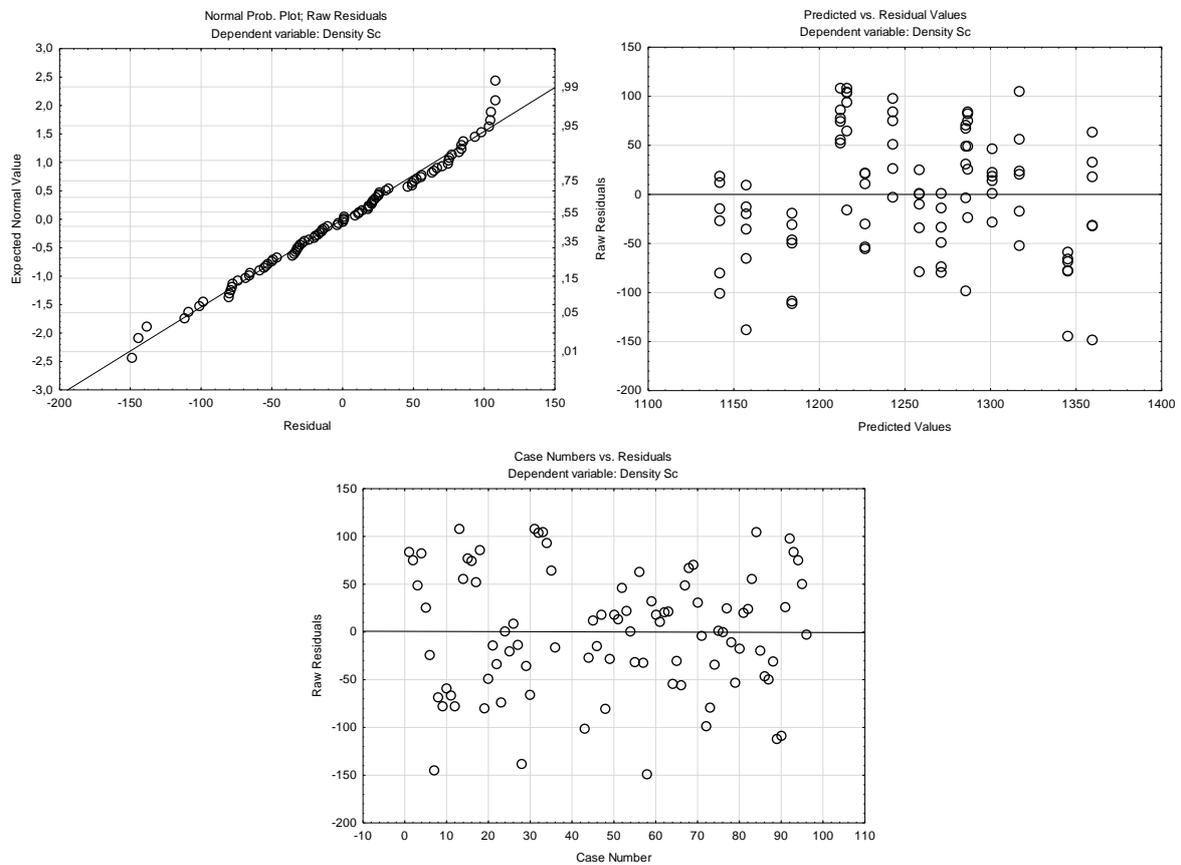


Figure IV.9: The normality of the distribution of residuals for Density Sc of Main ANOVA

# Appendix IV

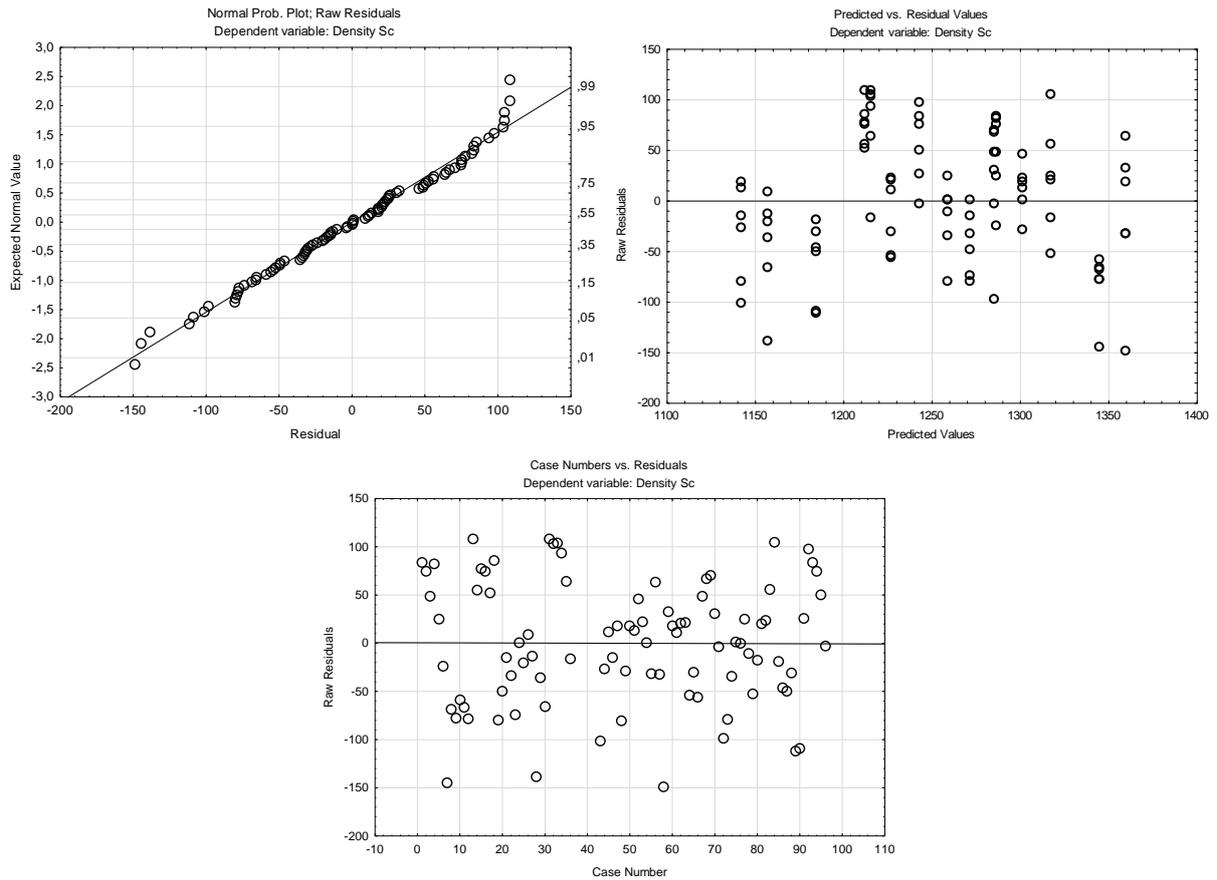


Figure IV.10: The normality of the distribution of residuals for Density of Nested ANOVA

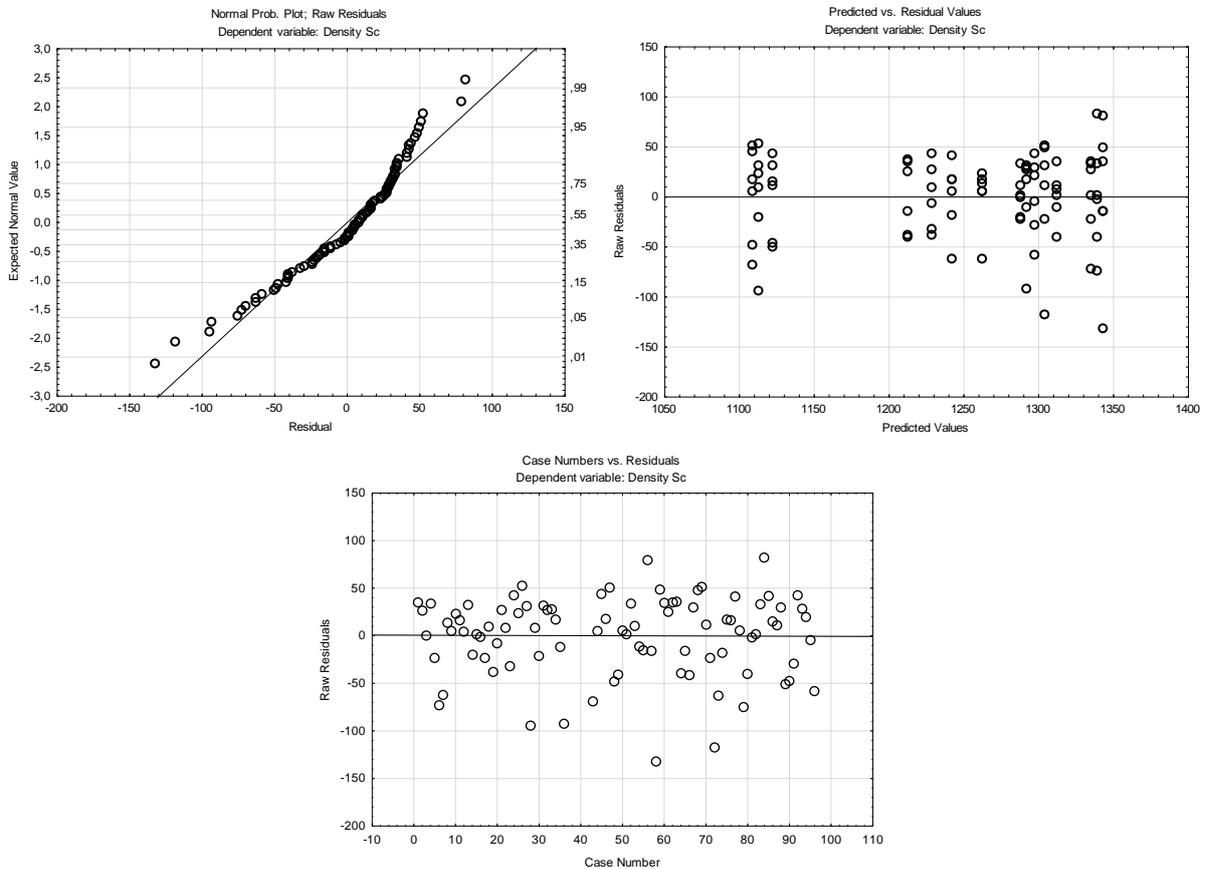


Figure IV.11: The normality of the distribution of residuals for Density Sc of Factorial ANOVA

# Appendix IV

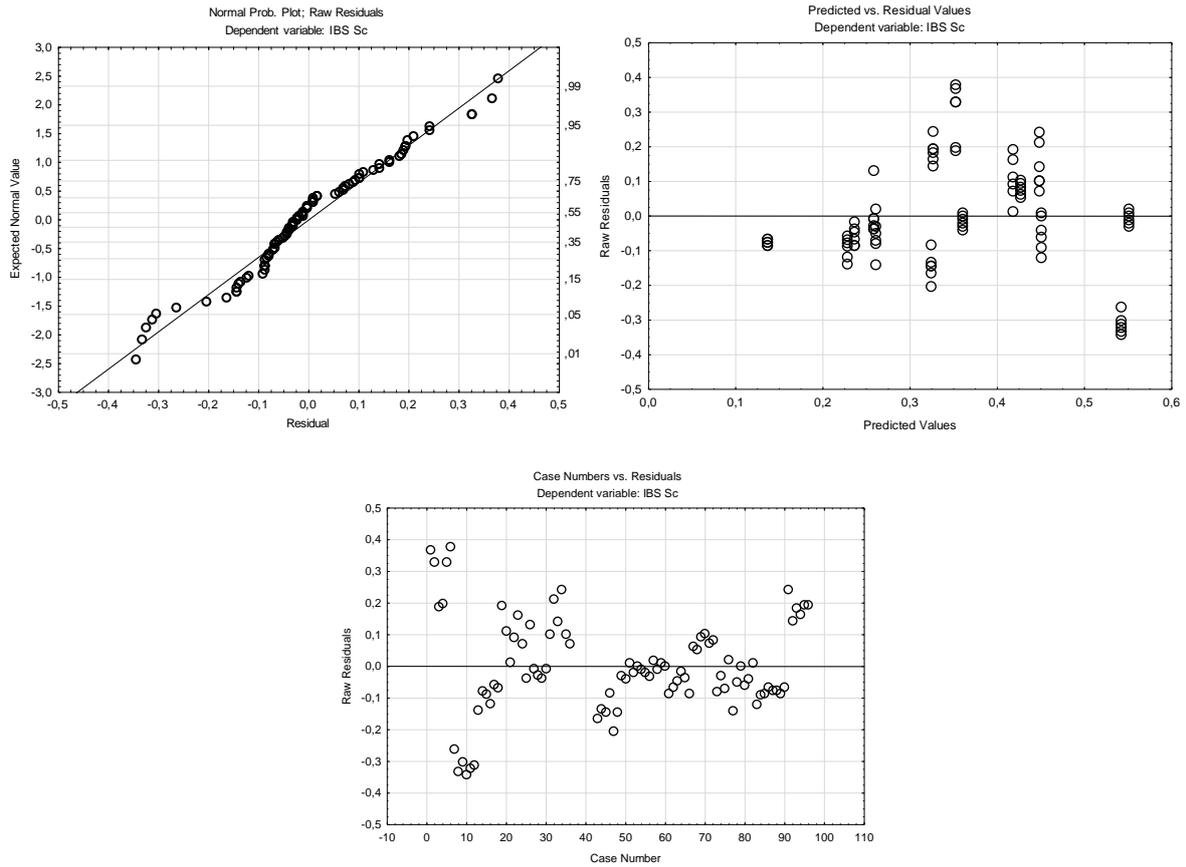


Figure IV.12: The normality of the distribution of residuals for IBS Sc of Main ANOVA

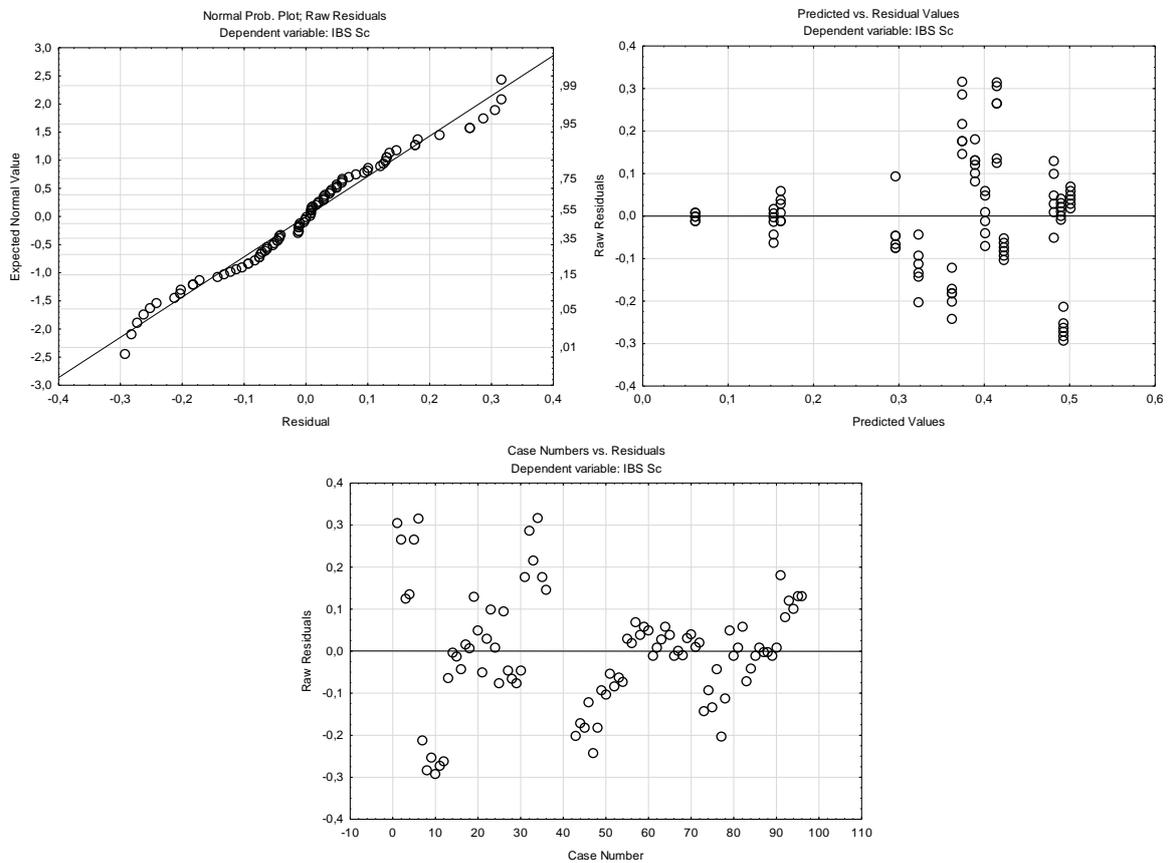


Figure IV.13: The normality of the distribution of residuals for IBS Sc of Nested ANOVA

# Appendix IV

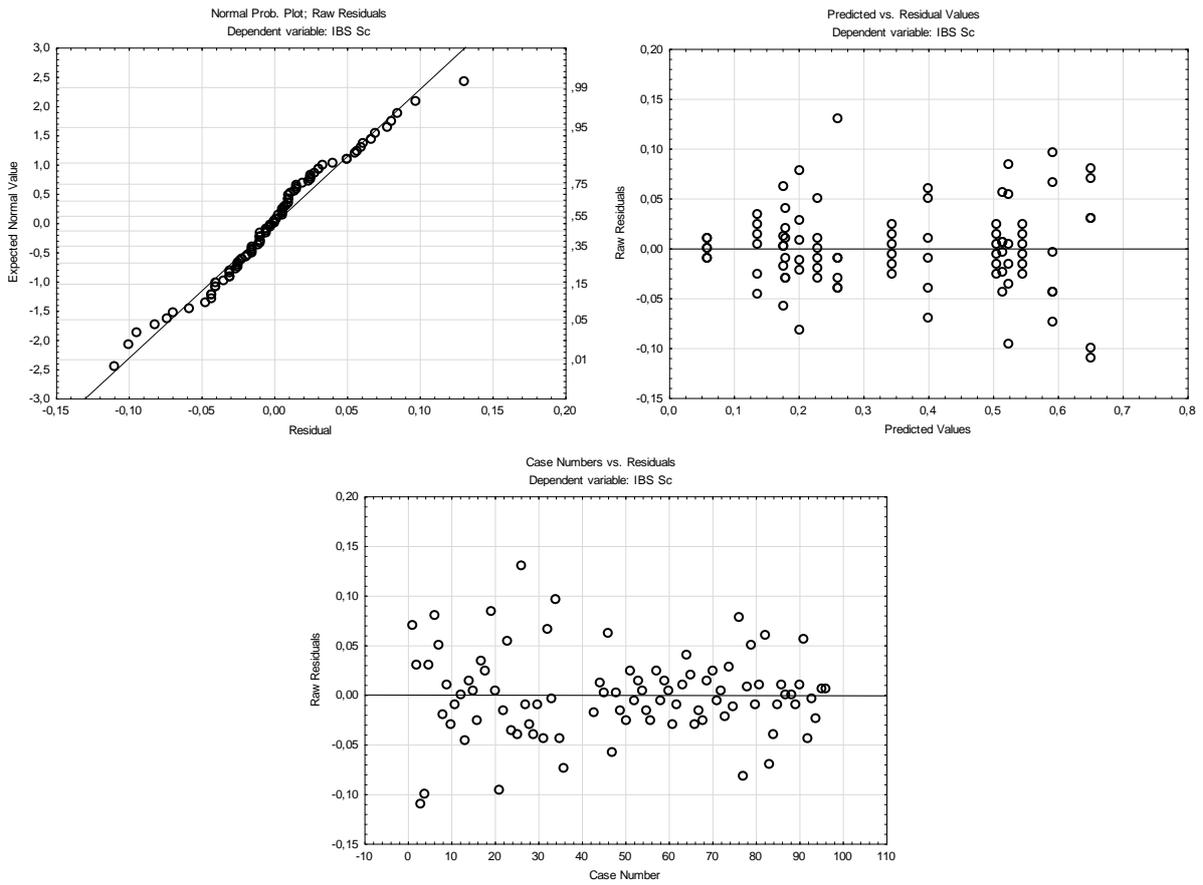


Figure IV.14: The normality of the distribution of residuals for IBS Sc of Factorial ANOVA

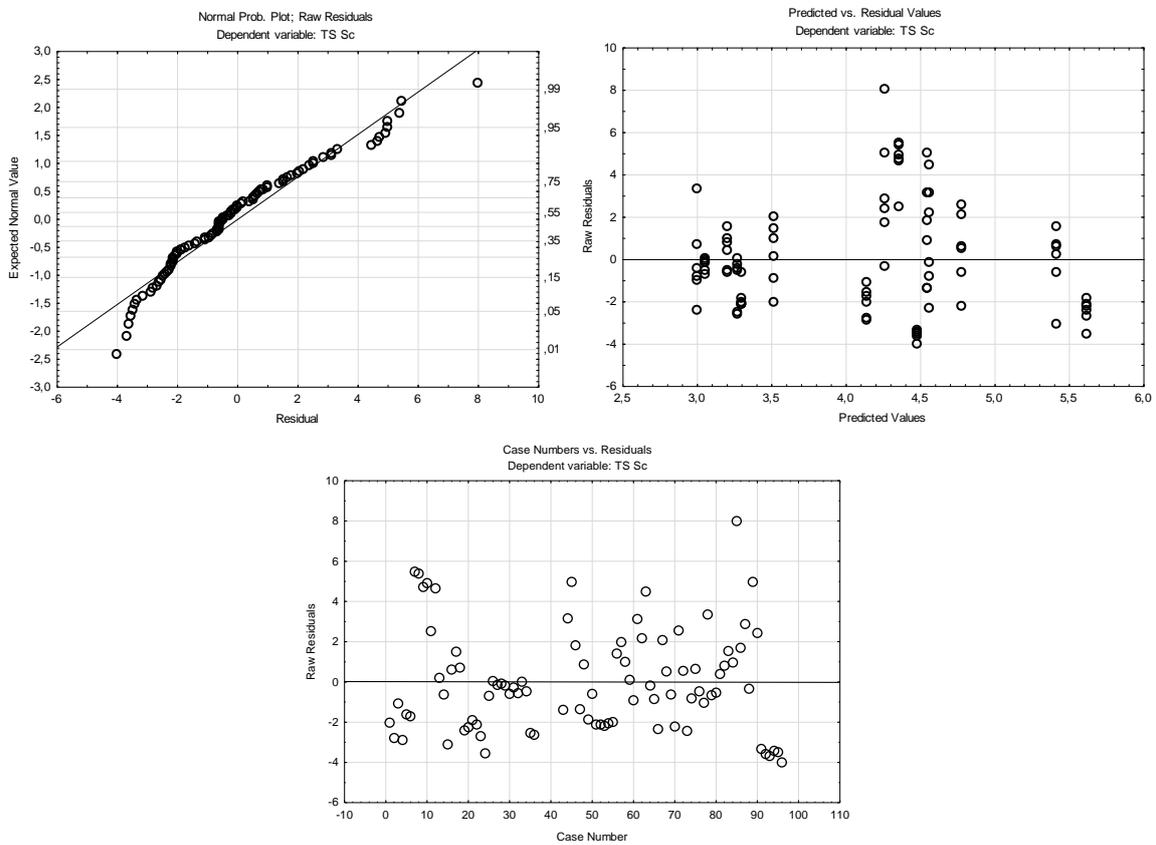


Figure IV.15: The normality of the distribution of residuals for TS Sc of Main ANOVA

# Appendix IV

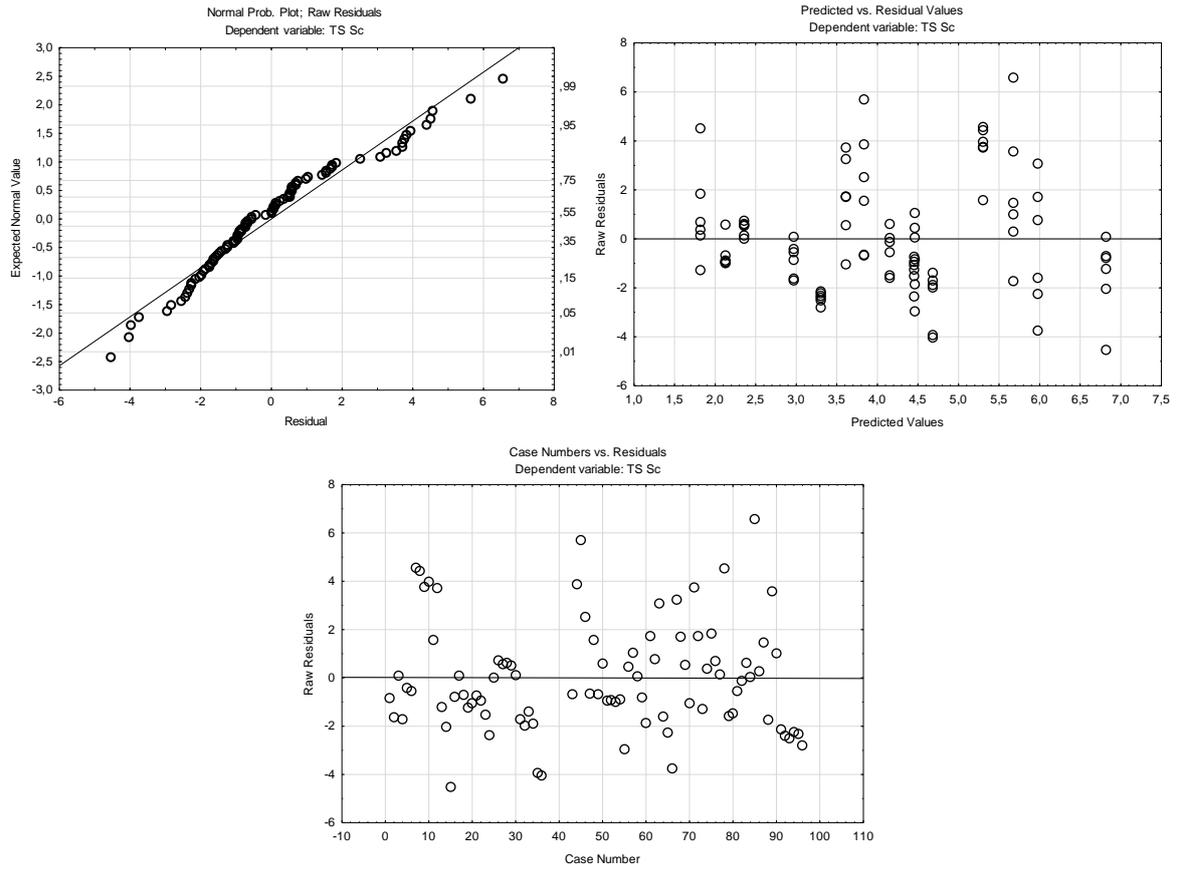


Figure IV.16: The normality of the distribution of residuals for TS Sc of Nested ANOVA

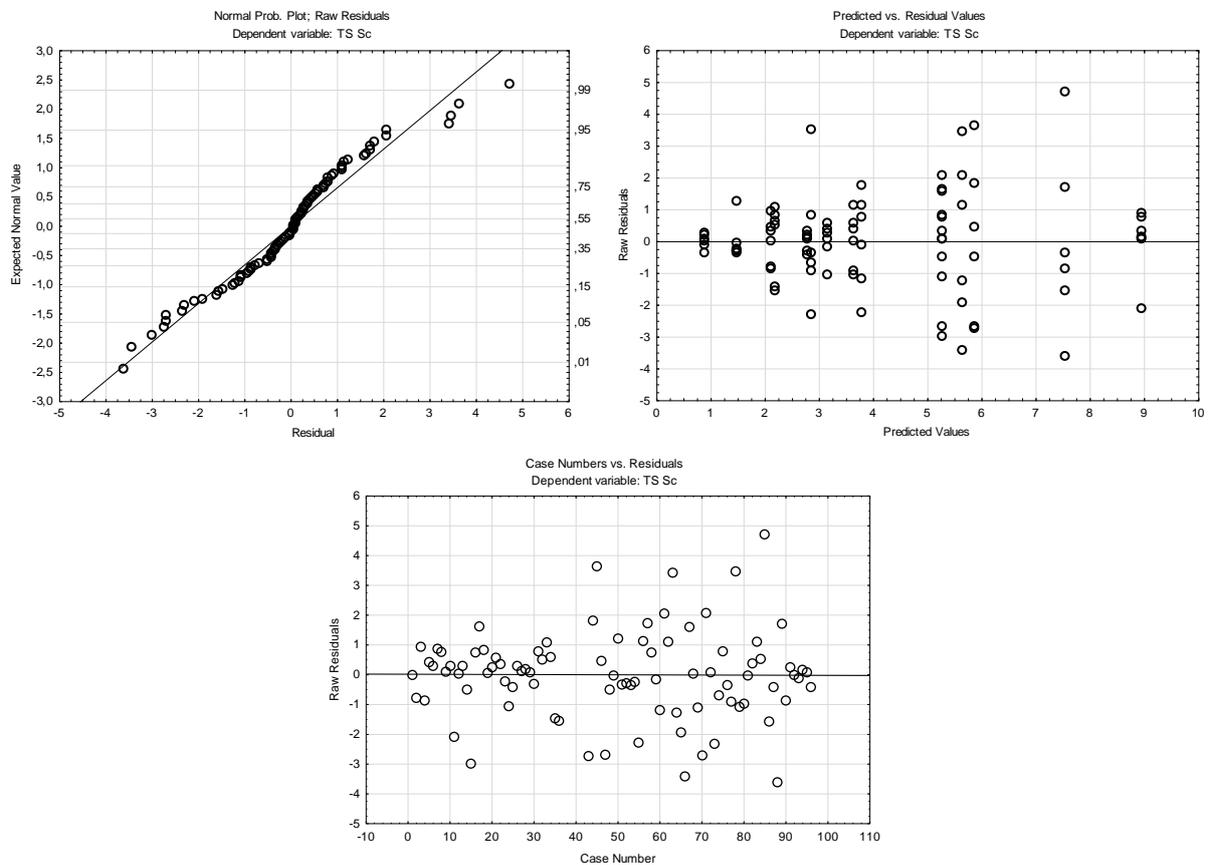


Figure IV.17: The normality of the distribution of residuals for TS Sc of Factorial ANOVA

# Appendix IV

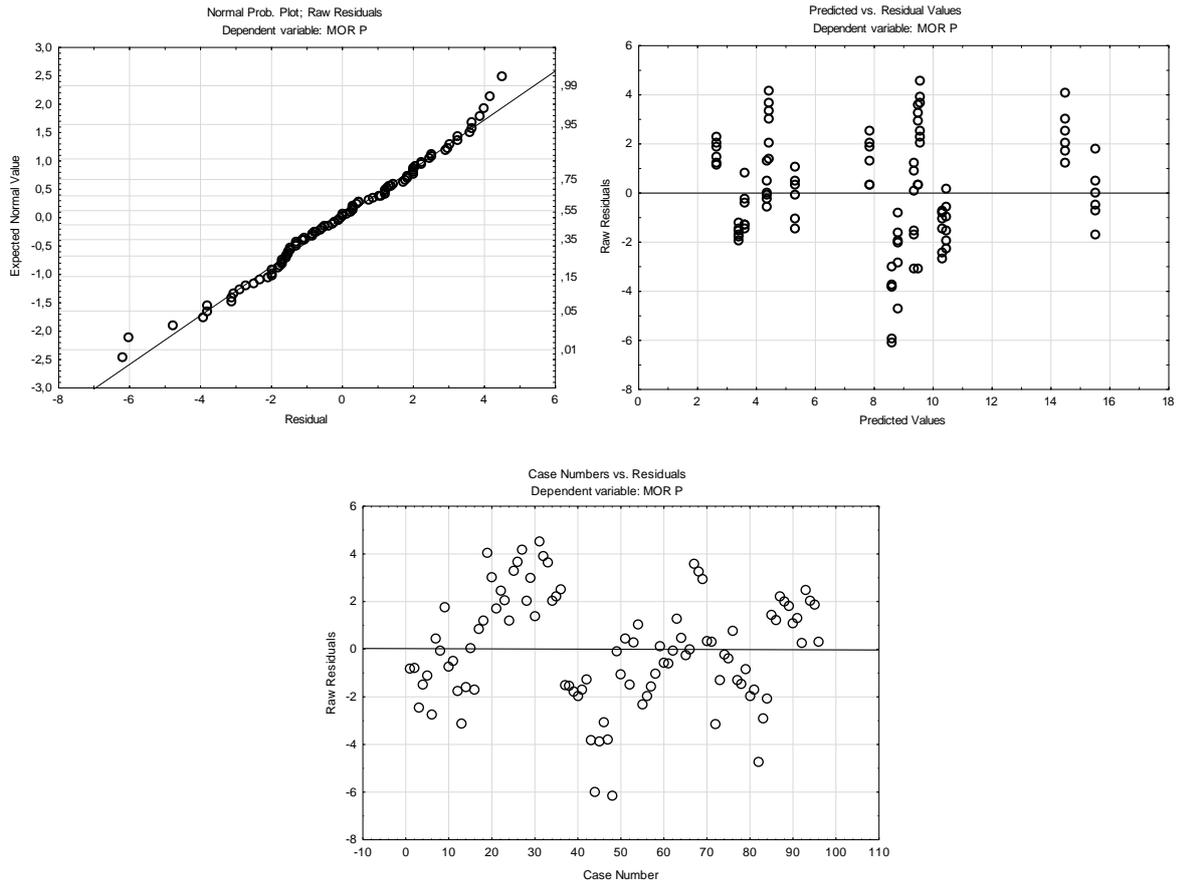


Figure IV.18: The normality of the distribution of residuals for MOR P of Main ANOVA

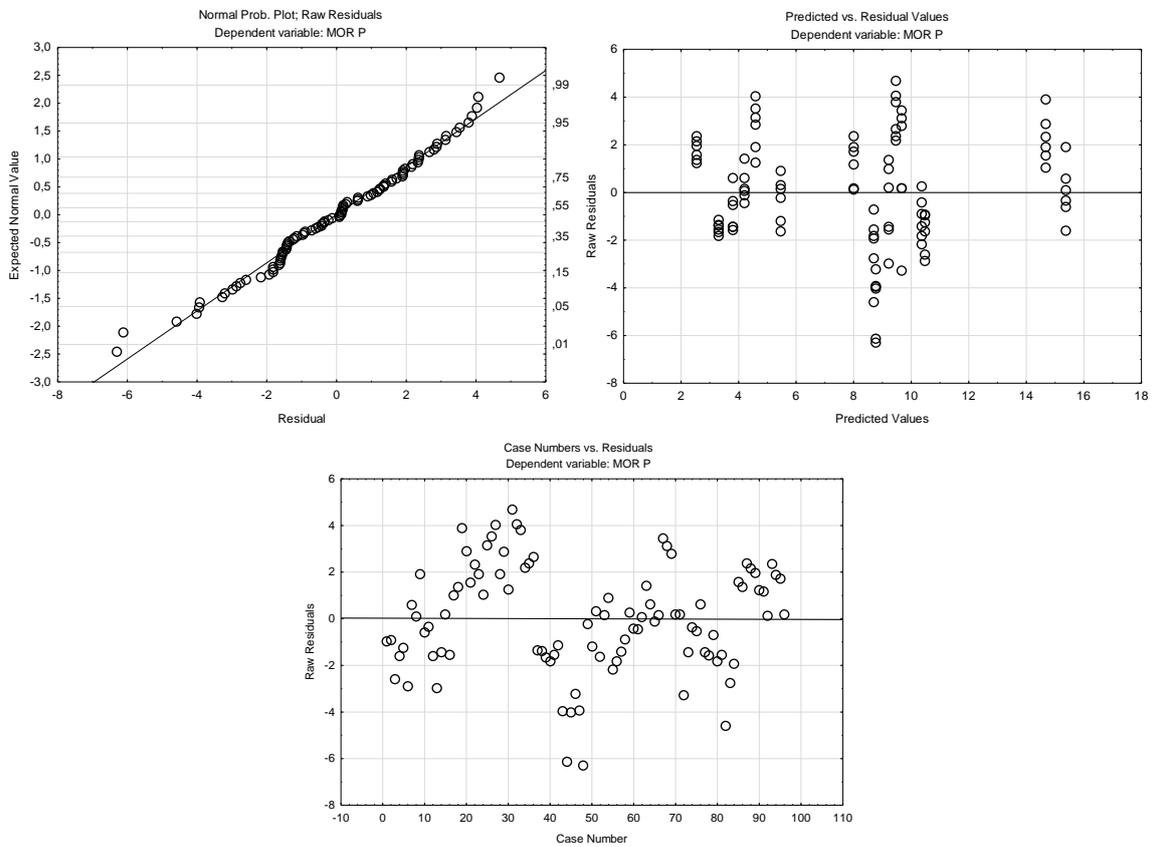


Figure IV.19: The normality of the distribution of residuals for MOR P of Nested ANOVA

# Appendix IV

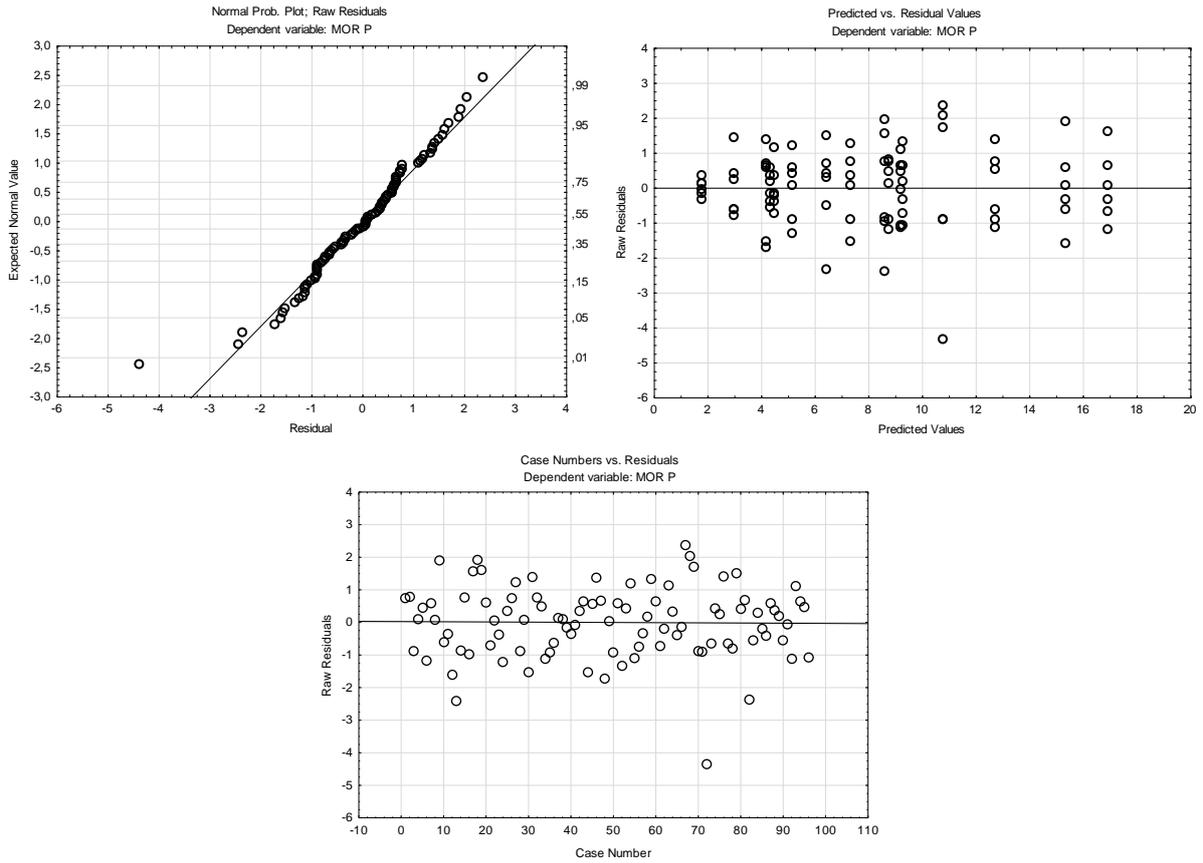


Figure IV.20: The normality of the distribution of residuals for MOR P of Factorial ANOVA

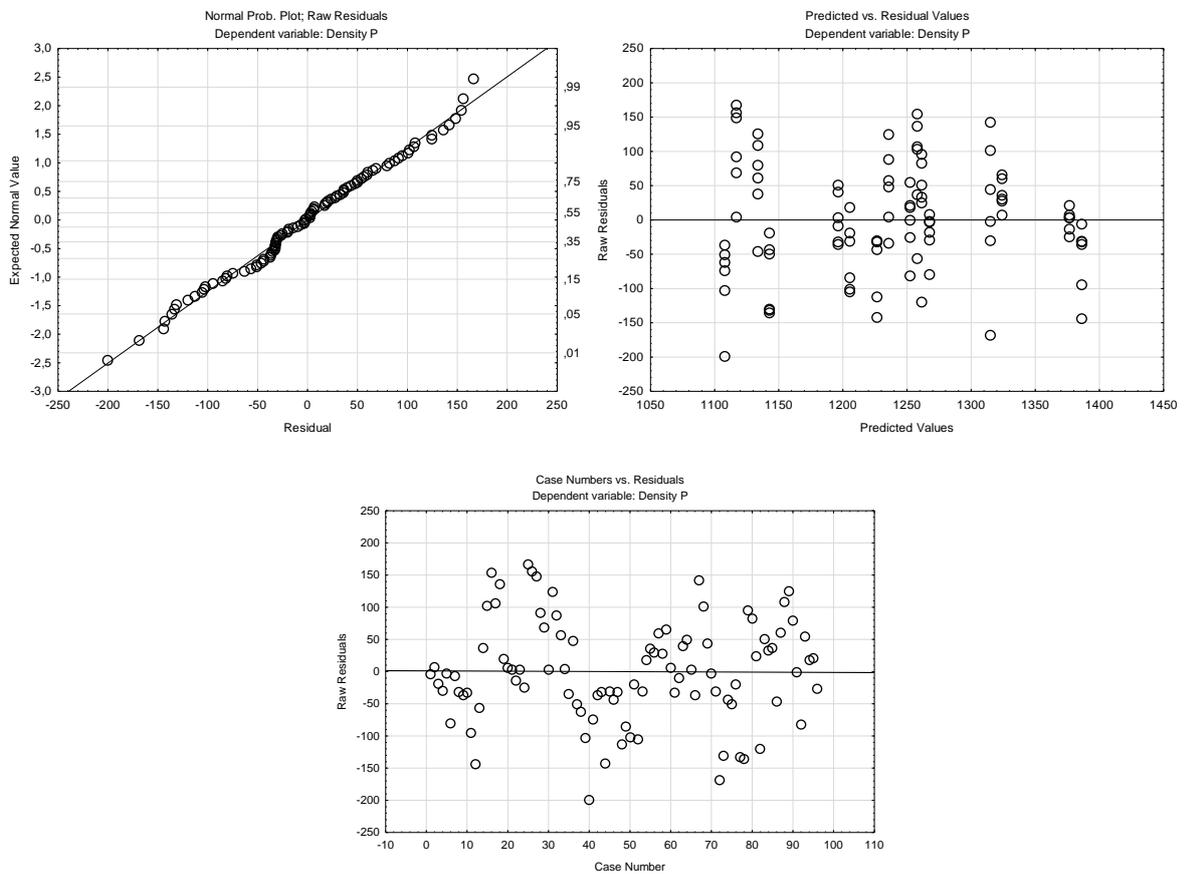


Figure IV.21: The normality of the distribution of residuals for Density P of Main ANOVA

# Appendix IV

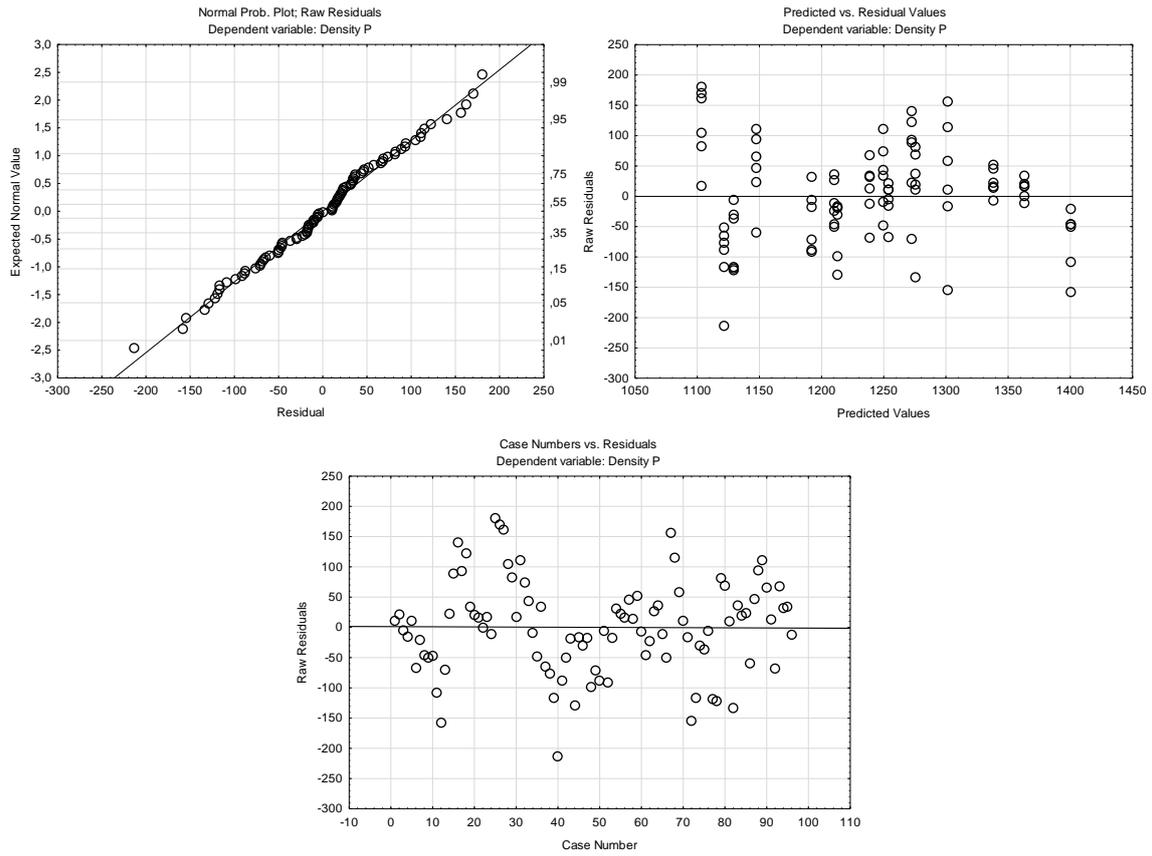


Figure IV.22: The normality of the distribution of residuals for Density P of Nested ANOVA

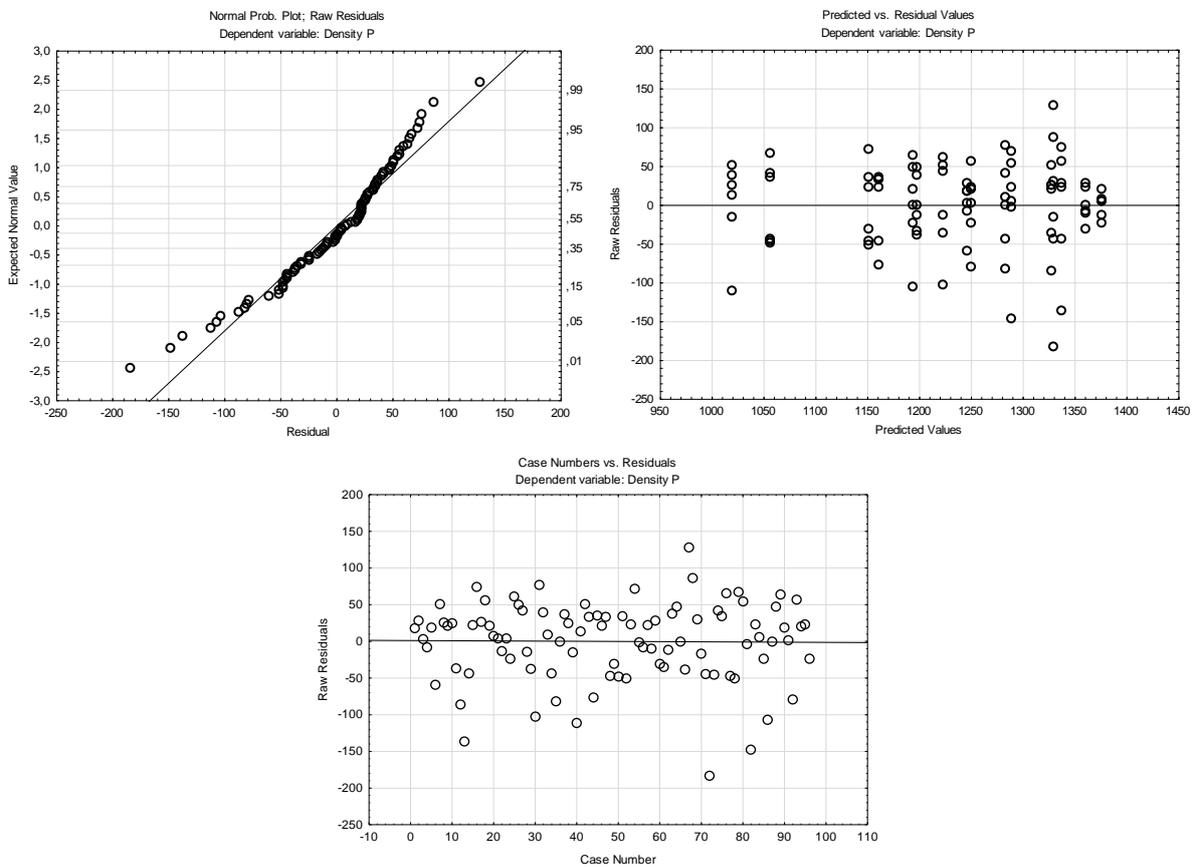


Figure IV.23: The normality of the distribution of residuals for Density P of Factorial ANOVA

# Appendix IV

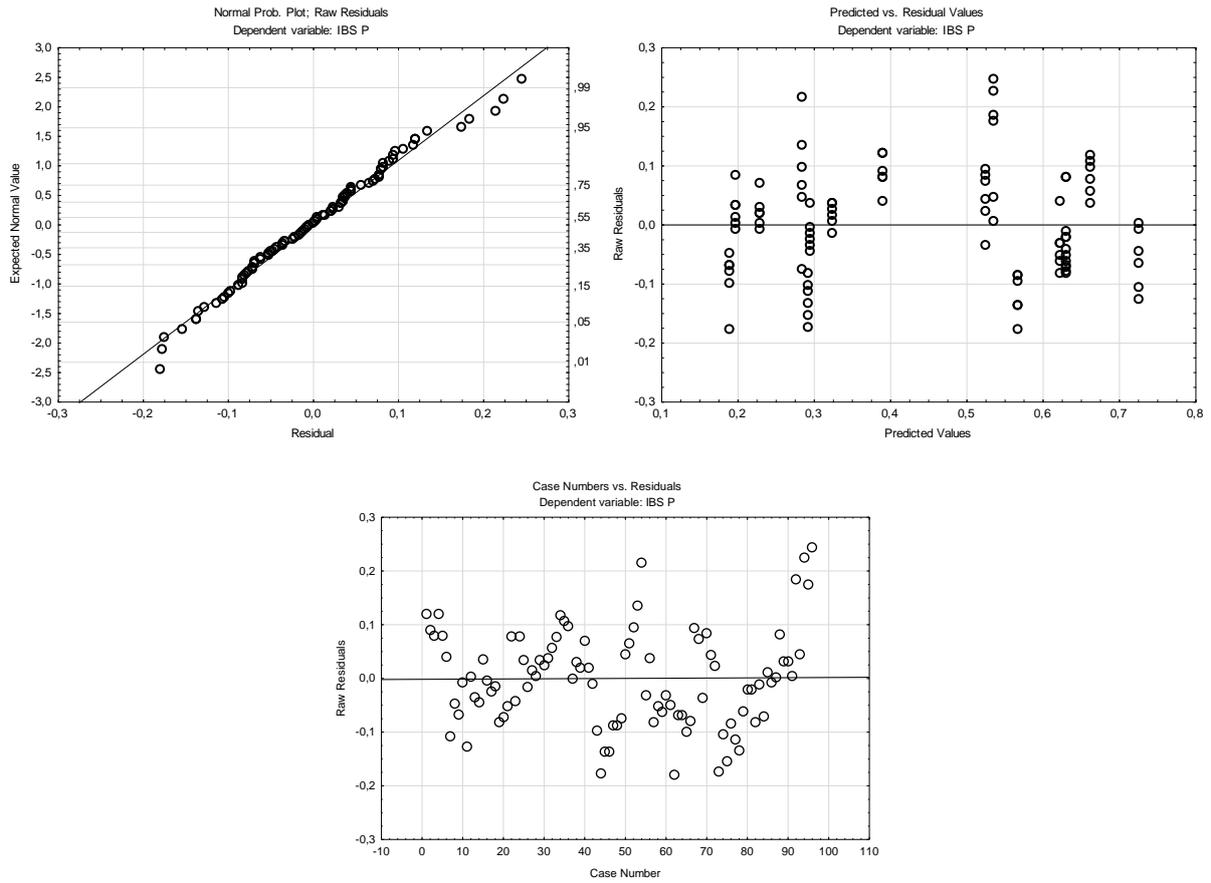


Figure IV.24: The normality of the distribution of residuals for IBS P of Main ANOVA

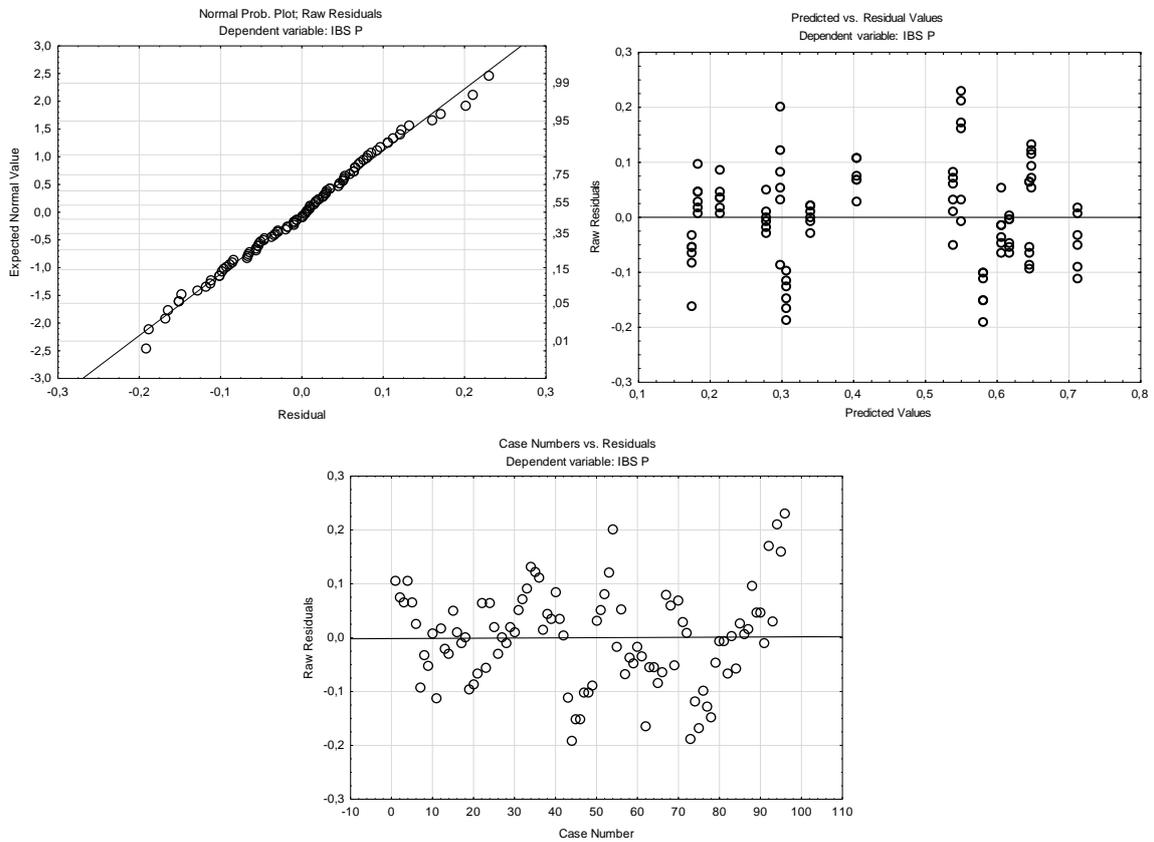


Figure IV.25: The normality of the distribution of residuals for IBS P of Nested ANOVA

# Appendix IV

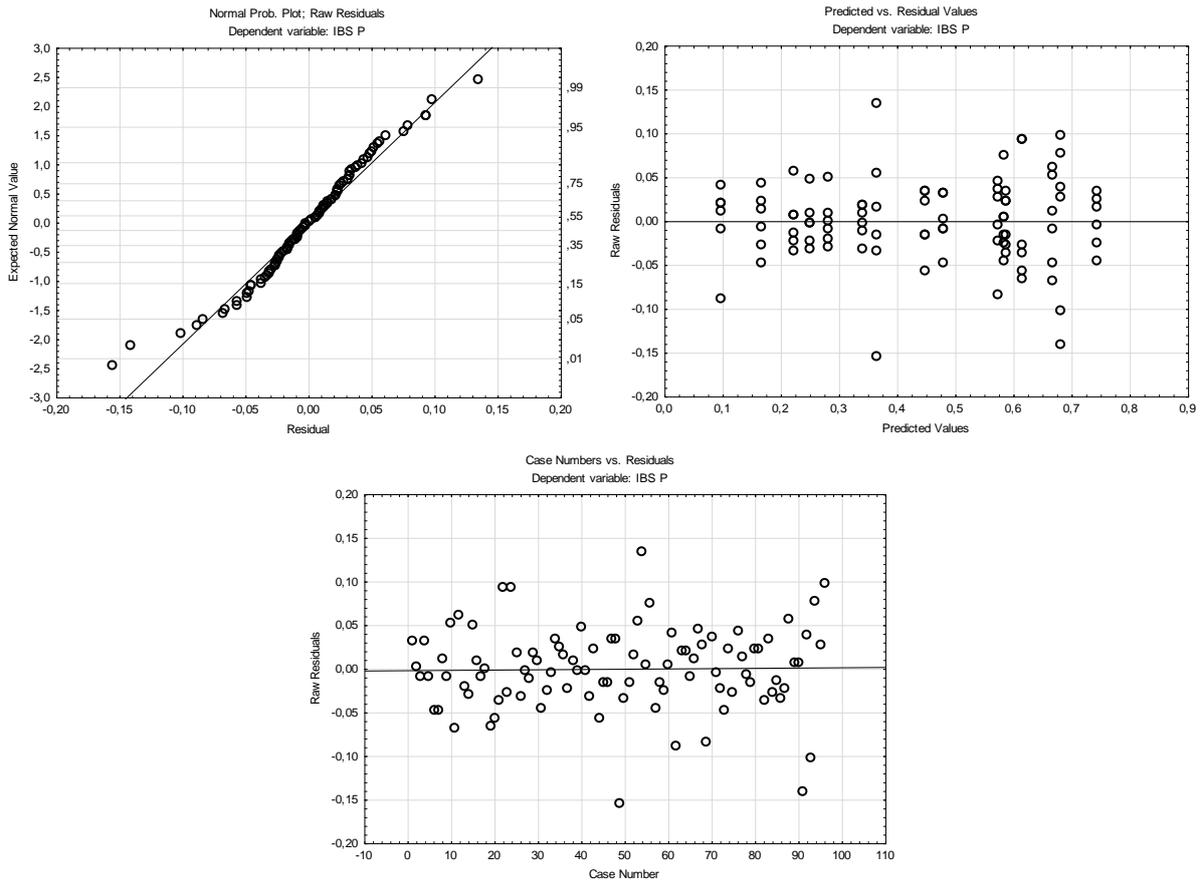


Figure IV.26: The normality of the distribution of residuals for IBS P of Factorial ANOVA

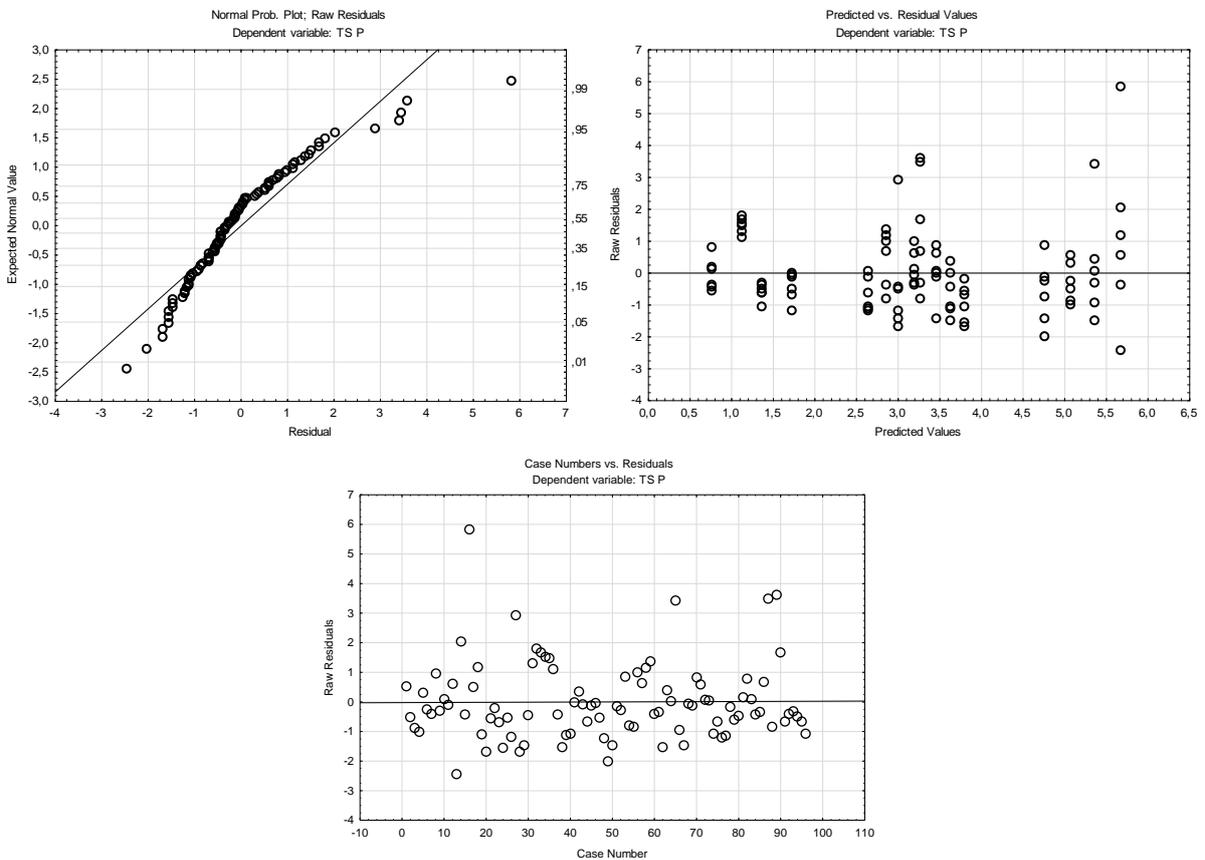


Figure IV.27: The normality of the distribution of residuals for TS P of Main ANOVA

# Appendix IV

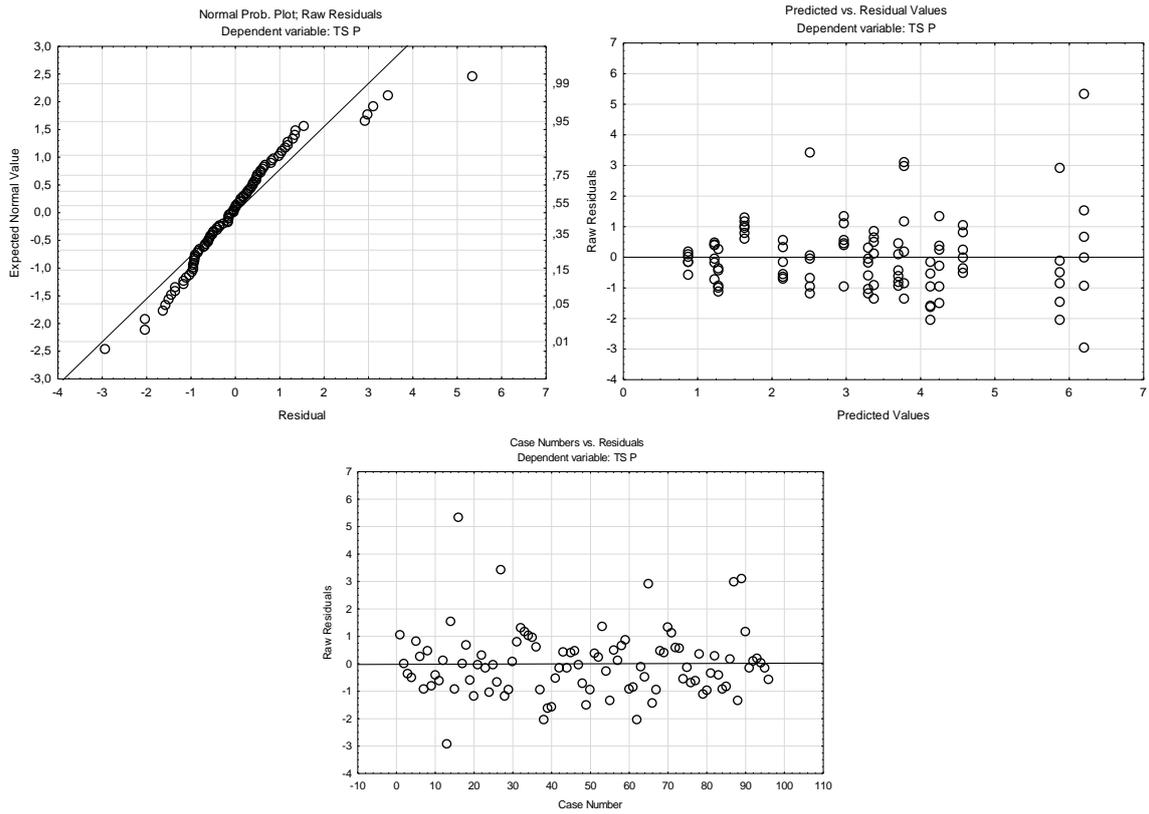


Figure IV.28: The normality of the distribution of residuals for TS P of Nested ANOVA

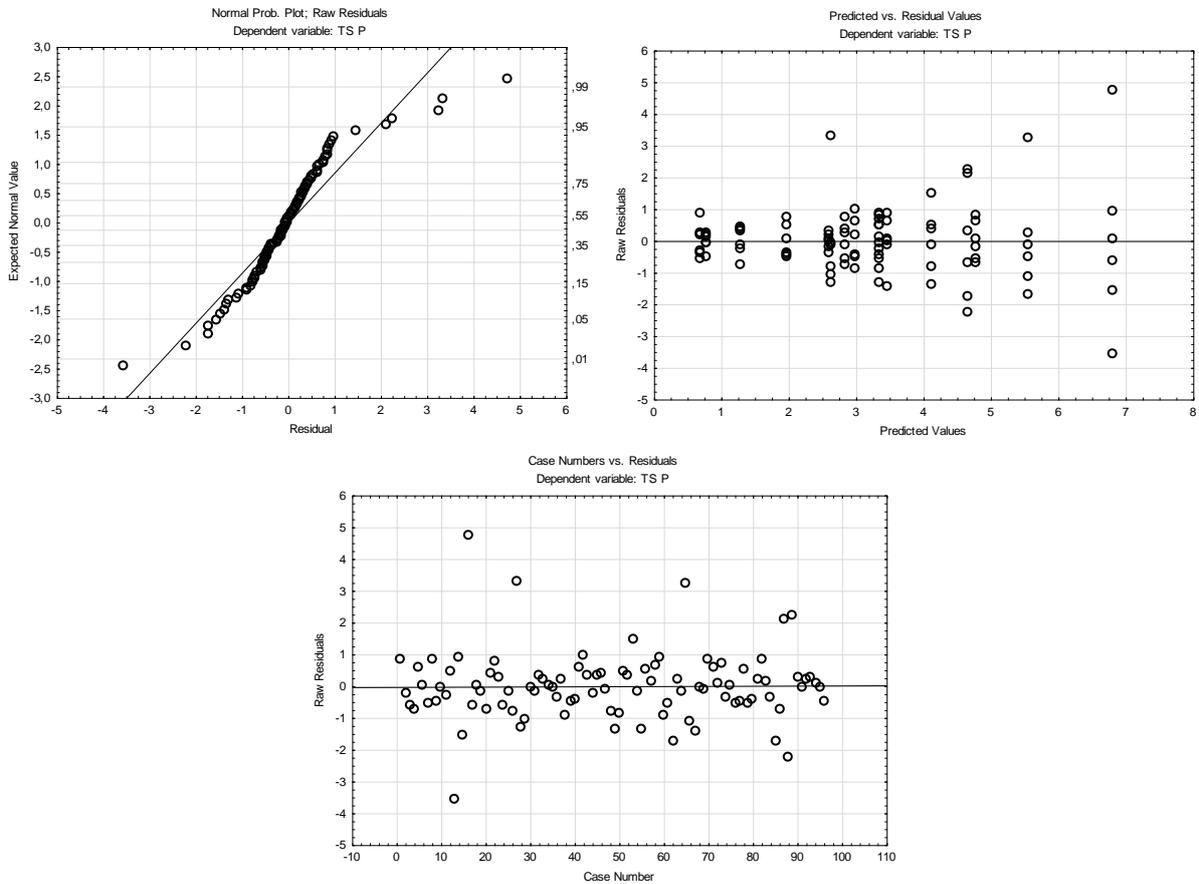


Figure IV.24: The normality of the distribution of residuals for TS P of Factorial ANOVA

## Appendix IV

Table IV.7: Newman-Keuls test. variable MOR Sc for Treatment with Main. Nested and Factoriel ANOVA.

Cell No.	Treatment Sc	Approximate Probabilities for Post Hoc Tests Error: Between MSE = 2.6446. df = 84.000 (Main ANOVA)				Approximate Probabilities for Post Hoc Tests Error: Between MSE = 2.5624. df = 83.000 (Nested ANOVA)			
		{1} 8.2268	{2} 6.2887	{3} 8.6421	{4} 6.0906	{1} 8.2268	{2} 6.2887	{3} 8.6421	{4} 6.0906
1	No treatment		0.000260	0.397833	0.000202		0.000232	0.390437	0.000181
2	Borax	0.000260		0.000123	0.686349	0.000232		0.000119	0.681647
3	DSHP 77 g/l	0.397833	0.000123		0.000151	0.390437	0.000119		0.000150
4	DAHP 150 g/l	0.000202	0.686349	0.000151		0.000181	0.681647	0.000150	
Approximate Probabilities for Post Hoc Tests Error: Between MSE = .63842. df = 75.000 (Factorial ANOVA)									
Cell No.	Treatment Sc	{1} 8.2268	{2} 6.2887	{3} 8.6421	{4} 6.0906				
1	No treatment			0.000114	0.087835	0.000110			
2	Borax	0.000114			0.000110	0.412081			
3	DSHP 77 g/l	0.087835	0.000110			0.000149			
4	DAHP 150 g/l	0.000110	0.412081		0.000149				

Table IV.8: Newman-Keuls test. variable MOR Sc for Additive with Main. Nested and Factoriel ANOVA.

Cell No.	Additives P	Approximate Probabilities for Post Hoc Tests Error: Between MSE = 2.6446. df = 84.000 (Main ANOVA)		Approximate Probabilities for Post Hoc Tests Error: Between MSE = 2.5624. df = 83.000 (Nested ANOVA)		Approximate Probabilities for Post Hoc Tests Error: Between MSE = .63842. df = 75.000 (Factorial ANOVA)	
		{1} 7.7741	{2} 6.9301	{1} 7.7741	{2} 6.9301	{1} 7.7741	{2} 6.9301
1	SS		0.016195		0.014665		0.000117
2	PDDA+MM	0.016195		0.014665		0.000117	

Table IV.9: Newman-Keuls test. variable MOR Sc for Concentration with Main. Nested and Factoriel ANOVA.

Cell No.	Concentration Sc	Approximate Probabilities for Post Hoc Tests Error: Between MSE = 2.6446. df = 84.000 (Main ANOVA)		Approximate Probabilities for Post Hoc Tests Error: Between MSE = 2.5624. df = 83.000 (Nested ANOVA)					
		{1} 5.5746	{2} 8.9602	Additives Sc	Concentration Sc	{1} 6.2127	{2} 9.3355	{3} 4.7237	{4} 8.5849
1	Low		0.000115	SS	2 (%)		0.000108	0.002818	0.000118
2	High	0.000115		SS	5 (%)	0.000108		0.000146	0.122545
3				PDDA+MM	0.2 (%)	0.002818	0.000146		0.000108
4				PDDA+MM	20 (%)	0.000118	0.122545	0.000108	
Approximate Probabilities for Post Hoc Tests Error: Between MSE = .63842. df = 75.000 (Factorial ANOVA)									
Cell No.	Concentration Sc				{1} 5.5746	{2} 8.9602			
1	Low						0.000114		
2	High				0.000114				

## Appendix IV

Table IV.10: Newman-Keuls test. variable Density Sc for Treatment with Main. Nested and Factoriel ANOVA.

Cell No.	Treatment Sc	Approximate Probabilities for Post Hoc Tests Error: Between MSE = 4240.8. df = 84.000 (Main ANOVA)				Approximate Probabilities for Post Hoc Tests Error: Between MSE = 2.5624. df = 83.000 (Nested ANOVA)			
		{1} 1279.1	{2} 1171.9	{3} 1293.3	{4} 1250.7	{1} 1279.1	{2} 1171.9	{3} 1293.3	{4} 1250.7
1	No treatment		0.000108	0.468582	0.151207		0.000109	0.471256	0.153675
2	Borax	0.000108		0.000146	0.000231	0.000109		0.000146	0.000243
3	DSHP 77 g/l	0.468582	0.000146		0.081132	0.471256	0.000146		0.083571
4	DAHP 150 g/l	0.151207	0.000231	0.081132		0.153675	0.000243	0.083571	
Approximate Probabilities for Post Hoc Tests Error: Between MSE = 2038.6. df = 75.000 (Factorial ANOVA)									
Cell No.	Treatment Sc	{1} 1279.1	{2} 1171.9	{3} 1293.3	{4} 1250.7				
1	No treatment			0.000110	0.296987	0.040127			
2	Borax	0.000110			0.000149	0.000114			
3	DSHP 77 g/l	0.296987		0.000149		0.006860			
4	DAHP 150 g/l	0.040127		0.000114	0.006860				

Table IV.11: Newman-Keuls test. variable Density Sc for Additive with Main. Nested and Factoriel ANOVA.

Cell No.	Additives P	Approximate Probabilities for Post Hoc Tests Error: Between MSE = 4240.8. df = 84.000 (Main ANOVA)		Approximate Probabilities for Post Hoc Tests Error: Between MSE = 2.5624. df = 83.000 (Nested ANOVA)		Approximate Probabilities for Post Hoc Tests Error: Between MSE = 2038.6. df = 75.000 (Factorial ANOVA)	
		{1} 1280.3	{2} 1223.7	{1} 1280.3	{2} 1223.7	{1} 1280.3	{2} 1223.7
1	SS		0.000199		0.000123		0.000114
2	PDDA+MM	0.000199		0.000123		0.000114	

Table IV.12: Newman-Keuls test. variable Density Sc for Concentration with Main. Nested and Factoriel ANOVA.

Cell No.	Concentration Sc	Approximate Probabilities for Post Hoc Tests Error: Between MSE = 4240.8. df = 84.000 (Main ANOVA)		Approximate Probabilities for Post Hoc Tests Error: Between MSE = 2.5624. df = 83.000 (Nested ANOVA)					
		{1} 5.5746	{2} 8.9602	Additives Sc	Concentration Sc	{1} 1251.1	{2} 1309.6	{3} 905.92	{4} 1235.5
1	Low		0.004842	SS	2 (%)		0.360354	0.000107	0.807032
2	High	0.004842		SS	5 (%)	0.360354		0.000144	0.477322
3				PDDA+MM	0.2 (%)	0.000107	0.000144		0.000114
4				PDDA+MM	20 (%)	0.807032	0.477322	0.000114	
Approximate Probabilities for Post Hoc Tests Error: Between MSE = 2038.6. df = 75.000 (Factorial ANOVA)									
Cell No.	Concentration Sc				{1} 1232.6	{2} 1272.5			
1	Low						0.000185		
2	High				0.000185				

## Appendix IV

Table IV.13: Newman-Keuls test. variable IBS Sc for Treatment with Main. Nested and Factoriel ANOVA.

Cell No.	Treatment Sc	Approximate Probabilities for Post Hoc Tests Error: Between MSE = .02366. df = 84.000 (Main ANOVA)				Approximate Probabilities for Post Hoc Tests Error: Between MSE = 2.5624. df = 83.000 (Nested ANOVA)			
		{1} .38542	{2} .34389	{3} .39375	{4} .29375	{1} .38542	{2} .34389	{3} .39375	{4} .29375
1	No treatment		0.371545	0.857431	0.122637		0.329960	0.844657	0.083666
2	Borax	0.371545		0.529788	0.281129	0.329960		0.470313	0.240106
3	DSHP 77 g/l	0.857431	0.529788		0.141964	0.844657	0.470313		0.093053
4	DAHP 150 g/l	0.122637	0.281129	0.141964		0.083666	0.240106	0.093053	
Approximate Probabilities for Post Hoc Tests Error: Between MSE = .00212. df = 75.000 (Factorial ANOVA)									
Cell No.	Treatment Sc	{1} .38542	{2} .34389	{3} .39375	{4} .29375				
1	No treatment			0.003780	0.548825	0.000110			
2	Borax	0.003780			0.001700	0.000634			
3	DSHP 77 g/l	0.548825	0.001700			0.000149			
4	DAHP 150 g/l	0.000110	0.000634	0.000149					

Table IV.14: Newman-Keuls test. variable IBS Sc for Additives with Main. Nested and Factoriel ANOVA.

Cell No.	Additives P	Approximate Probabilities for Post Hoc Tests Error: Between MSE = .02366. df = 84.000 Include cases (Main ANOVA)		Approximate Probabilities for Post Hoc Tests Error: Between MSE = .01988. df = 83.000 (Nested ANOVA)		Approximate Probabilities for Post Hoc Tests Error: Between MSE = .00212. df = 75.000 (Factorial ANOVA)	
		{1} .40313	{2} .29976	{1} .40313	{2} .29976	{1} .40313	{2} .29976
1	SS		0.002206		0.000952		0.000114
2	PDDA+MM	0.002206		0.000952		0.000114	

Table IV.15: Newman-Keuls test. variable IBS Sc for Concentration with Main. Nested and Factoriel ANOVA.

Cell No.	Concentration Sc	Approximate Probabilities for Post Hoc Tests Error: Between MSE = .02366. df = 84.000 (Main ANOVA)		Approximate Probabilities for Post Hoc Tests Error: Between MSE = .01988. df = 83.000 (Nested ANOVA)					
		{1} .26190	{2} .43625	Additives Sc	Concentration Sc	{1} .36417	{2} .44208	{3} .12556	{4} .43042
1	Low		0.000115	SS	2 (%)		0.163404	0.000115	0.121806
2	High	0.000115		SS	5 (%)	0.163404		0.000146	0.783831
3				PDDA+MM	0.2 (%)	0.000115	0.000146		0.000108
4				PDDA+MM	20 (%)	0.121806	0.783831	0.000108	
Approximate Probabilities for Post Hoc Tests Error: Between MSE = .00212. df = 75.000 (Factorial ANOVA)									
Cell No.	Concentration Sc				{1} .26190	{2} .43625			
1	Low						0.000114		
2	High					0.000114			

## Appendix IV

Table IV.16: Newman-Keuls test. variable TS Sc for Treatment with Main. Nested and Factoriel ANOVA.

Cell No.	Treatment Sc	Approximate Probabilities for Post Hoc Tests Error: Between MSE = 5.4099. df = 83.000 (Main ANOVA)				Approximate Probabilities for Post Hoc Tests Error: Between MSE = 2.5624. df = 83.000 (Nested ANOVA)			
		{1} 4.8850	{2} 3.6267	{3} 4.0425	{4} 3.7375	{1} 4.8850	{2} 3.6267	{3} 4.0425	{4} 3.7375
1	No treatment		0.378670	0.284226	0.311441		0.280484	0.231501	0.234038
2	Borax	0.378670		0.855891	0.887651	0.280484		0.823244	0.874466
3	DSHP 77 g/l	0.284226	0.855891		0.697476	0.231501	0.823244		0.663787
4	DAHP 150 g/l	0.311441	0.887651	0.697476		0.234038	0.874466	0.663787	
Approximate Probabilities for Post Hoc Tests Error: Between MSE = 2.5345. df = 75.000 (Factorial ANOVA)									
Cell No.	Treatment Sc	{1} 4.8850	{2} 3.6267	{3} 4.0425	{4} 3.7375				
1	No treatment			0.049716	0.082390	0.049154			
2	Borax	0.049716			0.661270	0.817508			
3	DSHP 77 g/l	0.082390		0.661270		0.525787			
4	DAHP 150 g/l	0.049154		0.817508	0.525787				

Table IV.17: Newman-Keuls test. variable TS Sc for Additive with Main. Nested and Factoriel ANOVA.

Cell No.	Additives P	Approximate Probabilities for Post Hoc Tests Error: Between MSE = 6.7662. df = 84.000 (Main ANOVA)		Approximate Probabilities for Post Hoc Tests Error: Between MSE = 5.4099. df = 83.000 Include cases (Nested ANOVA)		Approximate Probabilities for Post Hoc Tests Error: Between MSE = 2.5345. df = 75.000 (Factorial ANOVA)	
		{1} 3.4835	{2} 4.8102	{1} 3.4835	{2} 4.8102	{1} 3.4835	{2} 4.8102
1	SS		0.018052		0.008527		0.000285
2	PDDA+MM	0.018052		0.008527		0.000285	

Table IV.18: Newman-Keuls test. variable TS Sc for Concentration with Main. Nested and Factoriel ANOVA.

Cell No.	Concentration Sc	Approximate Probabilities for Post Hoc Tests Error: Between MSE = 7.0952. df = 90.000 (Main ANOVA)		Approximate Probabilities for Post Hoc Tests Error: Between MSE = 5.4099. df = 83.000 (Nested ANOVA)					
		{1} 3.4679	{2} 4.2246	Additives Sc	Concentration Sc	{1} 2.3179	{2} 4.6492	{3} 6.1572	{4} 3.8000
1	Low		0.167554	SS	2 (%)		0.003704	0.000148	0.037018
2	High	0.167554		SS	5 (%)	0.003704		0.033917	0.227862
3				PDDA+MM	0.2 (%)	0.000148	0.033917		0.003306
4				PDDA+MM	20 (%)	0.037018	0.227862	0.003306	
Approximate Probabilities for Post Hoc Tests Error: Between MSE = 2.5345. df = 75.000 (Factorial ANOVA)									
Cell No.	Concentration Sc				{1} 3.9633	{2} 4.2246			
1	Low						0.439937		
2	High				0.439937				

## Appendix IV

Table IV.19: Newman-Keuls test. variable MOR P for Treatment with Main. Nested and Factoriel ANOVA.

Cell No.	Treatment P	Approximate Probabilities for Post Hoc Tests Error: Between MSE = 5.4576. df = 90.000 (Main ANOVA)				Approximate Probabilities for Post Hoc Tests Error: Between MSE = 5.4970. df = 89.000 (Nested ANOVA)			
		{1} 12.433	{2} 6.5346	{3} 7.4285	{4} 5.7581	{1} 12.433	{2} 6.5346	{3} 7.4285	{4} 5.7581
1	No treatment		0.000106	0.000113	0.000144		0.000106	0.000113	0.000144
2	Borax	0.000106		0.188488	0.252698	0.000106		0.190100	0.254426
3	DSHP 77 g/l	0.000113	0.188488		0.039830	0.000113	0.190100		0.040767
4	DAHP 150 g/l	0.000144	0.252698	0.039830		0.000144	0.254426	0.040767	
Approximate Probabilities for Post Hoc Tests Error: Between MSE = 1.3904. df = 80.000 (Factorial ANOVA)									
Cell No.	Treatment P	{1} 12.433	{2} 6.5346	{3} 7.4285	{4} 5.7581				
1	No treatment			0.000108	0.000117	0.000147			
2	Borax	0.000108			0.010466	0.025298			
3	DSHP 77 g/l	0.000117		0.010466		0.000120			
4	DAHP 150 g/l	0.000147		0.025298	0.000120				

Table IV.20: Newman-Keuls test. variable MOR P for Additive with Main. Nested and Factoriel ANOVA.

Cell No.	Additives P	Approximate Probabilities for Post Hoc Tests Error: Between MSE = 5.4576. df = 90.000 (Main ANOVA)		Approximate Probabilities for Post Hoc Tests Error: Between MSE = 5.4970. df = 89.000 (Nested ANOVA)		Approximate Probabilities for Post Hoc Tests Error: Between MSE = 1.3904. df = 80.000 (Factorial ANOVA)	
		{1} 8.5273	{2} 7.5498	{1} 8.5273	{2} 7.5498	{1} 8.5273	{2} 7.5498
1	SS		0.043380		0.044163		0.000224
2	PDDA+MM	0.043380		0.044163		0.000224	

Table IV.21: Newman-Keuls test. variable MOR P for Concentration with Main. Nested and Factoriel ANOVA.

Cell No.	Concentration P	Approximate Probabilities for Post Hoc Tests Error: Between MSE = 5.4576. df = 90.000 (Main ANOVA)		Approximate Probabilities for Post Hoc Tests Error: Between MSE = 5.4970. df = 89.000 (Nested ANOVA)					
		{1} 5.4503	{2} 10.627	Additives P	Concentration P	{1} 6.0816	{2} 10.973	{3} 4.8189	{4} 10.281
1	Low		0.000113	SS	2 (%)		0.000106	0.065490	0.000113
2	High	0.000113		SS	5 (%)	0.000106		0.000144	0.309295
3				PDDA+MM	0.2 (%)	0.065490	0.000144		0.000106
4				PDDA+MM	20 (%)	0.000113	0.309295	0.000106	
Approximate Probabilities for Post Hoc Tests Error: Between MSE = 1.3904. df = 80.000 (Factorial ANOVA)									
Cell No.	Concentration P				{1} 5.4503	{2} 10.627			
1	Low						0.000117		
2	High				0.000117				

## Appendix IV

Table IV.22: Newman-Keuls test. variable Density P for Treatment with Main. Nested and Factoriel ANOVA.

Cell No.	Treatment P	Approximate Probabilities for Post Hoc Tests Error: Between MSE = 6483.6. df = 90.000 (Main ANOVA)				Approximate Probabilities for Post Hoc Tests Error: Between MSE = 6351.0. df = 89.000 (Nested ANOVA)			
		{1} 1322.3	{2} 1171.9	{3} 1260.4	{4} 1197.8	{1} 1322.3	{2} 1171.9	{3} 1260.4	{4} 1197.8
1	No treatment		0.000144	0.009258	0.000108		0.000144	0.008604	0.000107
2	Borax	0.000144		0.000842	0.268474	0.000144		0.000753	0.263605
3	DSHP 77 g/l	0.009258	0.000842		0.008584	0.008604	0.000753		0.007968
4	DAHP 150 g/l	0.000108	0.268474	0.008584		0.000107	0.263605	0.007968	
Approximate Probabilities for Post Hoc Tests Error: Between MSE = 3395.1. df = 80.000 (Factorial ANOVA)									
Cell No.	Treatment P	{1} 1322.3	{2} 1171.9	{3} 1260.4	{4} 1197.8				
1	No treatment		0.000147	0.000534	0.000108				
2	Borax	0.000147		0.000111	0.127867				
3	DSHP 77 g/l	0.000534	0.000111		0.000475				
4	DAHP 150 g/l	0.000108	0.127867	0.000475					

Table IV.23: Newman-Keuls test. variable Density P for Additive with Main. Nested and Factoriel ANOVA.

Cell No.	Additives P	Approximate Probabilities for Post Hoc Tests Error: Between MSE = 6483.6. df = 90.000 (Main ANOVA)		Approximate Probabilities for Post Hoc Tests Error: Between MSE = 6351.0. df = 89.000 (Nested ANOVA)		Approximate Probabilities for Post Hoc Tests Error: Between MSE = 3395.1. df = 80.000 (Factorial ANOVA)	
		{1} 1242.7	{2} 1233.5	{1} 1242.7	{2} 1233.5	{1} 1242.7	{2} 1233.5
1	SS		0.576590		0.572661		0.440945
2	PDDA+MM	0.576590		0.572661		0.440945	

Table IV.24: Newman-Keuls test. variable Density P for Concentration with Main. Nested and Factoriel ANOVA.

Cell No.	Concentration P	Approximate Probabilities for Post Hoc Tests Error: Between MSE = 6483.6. df = 90.000 (Main ANOVA)		Approximate Probabilities for Post Hoc Tests Error: Between MSE = 6351.0. df = 89.000 (Nested ANOVA)					
		{1} 1178.7	{2} 1297.4	Additives P	Concentration P	{1} 1169.5	{2} 1315.9	{3} 1187.9	{4} 1279.0
1	Low		0.000113	SS	2 (%)		0.000144	0.426466	0.000125
2	High	0.000113		SS	5 (%)	0.000144		0.000107	0.113222
3				PDDA+MM	0.2 (%)	0.426466	0.000107		0.000257
4				PDDA+MM	20 (%)	0.000125	0.113222	0.000257	
Approximate Probabilities for Post Hoc Tests Error: Between MSE = 3395.1. df = 80.000 (Factorial ANOVA)									
Cell No.	Concentration P				{1} 1178.7	{2} 1297.4			
1	Low						0.000117		
2	High					0.000117			

## Appendix IV

Table IV.25: Newman-Keuls test. variable IBS P for Treatment with Main. Nested and Factoriel ANOVA.

Cell No.	Treatment P	Approximate Probabilities for Post Hoc Tests Error: Between MSE = .00845. df = 90.000 (Main ANOVA)				Approximate Probabilities for Post Hoc Tests Error: Between MSE = .00832. df = 89.000 (Nested ANOVA)			
		{1} .51083	{2} .44625	{3} .40542	{4} .41458	{1} .51083	{2} .44625	{3} .40542	{4} .41458
1	No treatment		0.017029	0.000925	0.001463		0.016234	0.000847	0.001346
2	Borax	0.017029		0.277997	0.236015	0.016234		0.272606	0.232422
3	DSHP 77 g/l	0.000925	0.277997		0.730731	0.000847	0.272606		0.728711
4	DAHP 150 g/l	0.001463	0.236015	0.730731		0.001346	0.232422	0.728711	
Approximate Probabilities for Post Hoc Tests Error: Between MSE = .00260. df = 80.000 (Factorial ANOVA)									
Cell No.	Treatment P	{1} .51083	{2} .44625	{3} .40542	{4} .41458				
1	No treatment			0.000149	0.000147	0.000108			
2	Borax	0.000149			0.018779	0.034538			
3	DSHP 77 g/l	0.000147	0.018779			0.535292			
4	DAHP 150 g/l	0.000108	0.034538		0.535292				

Table IV.26: Newman-Keuls test. variable IBS P for Additive with Main. Nested and Factoriel ANOVA.

Cell No.	Additives P	Approximate Probabilities for Post Hoc Tests Error: Between MSE = .00845. df = 90.000 (Main ANOVA)		Approximate Probabilities for Post Hoc Tests Error: Between MSE = .00832. df = 89.000 (Nested ANOVA)		Approximate Probabilities for Post Hoc Tests Error: Between MSE = .00260. df = 80.000 (Factorial ANOVA)	
		{1} .49208	{2} .39646	{1} .49208	{2} .39646	{1} .49208	{2} .39646
1	SS		0.000114		0.000114		0.000117
2	PDDA+MM	0.000114		0.000114		0.000117	

Table IV.27: Newman-Keuls test. variable IBS P for Concentration with Main. Nested and Factoriel ANOVA.

Cell No.	Concentration P	Approximate Probabilities for Post Hoc Tests Error: Between MSE = .00845. df = 90.000 (Main ANOVA)		Approximate Probabilities for Post Hoc Tests Error: Between MSE = .00832. df = 89.000 (Nested ANOVA)					
		{1} .27562	{2} .61292	Additives P	Concentration P	{1} .33792	{2} .64625	{3} .21333	{4} .57958
1	Low		0.000113	SS	2 (%)		0.000106	0.000120	0.000113
2	High	0.000113		SS	5 (%)	0.000106		0.000144	0.013211
3				PDDA+MM	0.2 (%)	0.000120	0.000144		0.000106
4				PDDA+MM	20 (%)	0.000113	0.013211	0.000106	
Approximate Probabilities for Post Hoc Tests Error: Between MSE = .00260. df = 80.000 (Factorial ANOVA)									
Cell No.	Concentration P				{1} .27562	{2} .61292			
1	Low						0.000117		
2	High					0.000117			

## Appendix IV

Table IV.28: Newman-Keuls test. variable TS P for Treatment with Main. Nested and Factoriel ANOVA.

Cell No.	Treatment P	Approximate Probabilities for Post Hoc Tests Error: Between MSE = 1.8099. df = 90.000 (Main ANOVA)				Approximate Probabilities for Post Hoc Tests Error: Between MSE = 1.5513. df = 89.000 (Nested ANOVA)			
		{1} 4.4404	{2} 2.3750	{3} 4.1163	{4} 2.0167	{1} 4.4404	{2} 2.3750	{3} 4.1163	{4} 2.0167
1	No treatment		0.000108	0.406242	0.000144		0.000107	0.369828	0.000144
2	Borax	0.000108		0.000132	0.358767	0.000107		0.000118	0.321764
3	DSHP 77 g/l	0.406242	0.000132		0.000107	0.369828	0.000118		0.000107
4	DAHP 150 g/l	0.000144	0.358767	0.000107		0.000144	0.321764	0.000107	
Approximate Probabilities for Post Hoc Tests Error: Between MSE = 1.3843. df = 80.000 (Factorial ANOVA)									
Cell No.	Treatment P	{1} 4.4404	{2} 2.3750	{3} 4.1163	{4} 2.0167				
1	No treatment			0.000108	0.342861	0.000147			
2	Borax	0.000108			0.000119	0.294672			
3	DSHP 77 g/l	0.342861				0.000108			
4	DAHP 150 g/l	0.000147		0.294672		0.000108			

Table IV.29: Newman-Keuls test. variable TS P for Additive with Main, Nested and Factoriel ANOVA.

Cell No.	Additives P	Approximate Probabilities for Post Hoc Tests Error: Between MSE = 1.8099. df = 90.000 (Main ANOVA)		Approximate Probabilities for Post Hoc Tests Error: Between MSE = 1.5513. df = 89.000 (Nested ANOVA)		Approximate Probabilities for Post Hoc Tests Error: Between MSE = 1.3843. df = 80.000 (Factorial ANOVA)	
		{1} 2.9323	{2} 3.5419	{1} 2.9323	{2} 3.5419	{1} 2.9323	{2} 3.5419
1	SS		0.029039		0.018695		0.013190
2	PDDA+MM	0.029039		0.018695		0.013190	

Table IV.30: Newman-Keuls test. variable TS P for Concentration with Main. Nested and Factoriel ANOVA.

Cell No.	Concentration P	Approximate Probabilities for Post Hoc Tests Error: Between MSE = 1.8099. df = 90.000 (Main ANOVA)		Approximate Probabilities for Post Hoc Tests Error: Between MSE = 1.5513. df = 89.000 (Nested ANOVA)					
		{1} 4.1821	{2} 2.2921	Additives P	Concentration P	{1} 3.3688	{2} 2.4958	{3} 4.9954	{4} 2.0883
1	Low		0.000113	SS	2 (%)		0.017300	0.000130	0.001799
2	High	0.000113		SS	5 (%)	0.017300		0.000106	0.260187
3				PDDA+MM	0.2 (%)	0.000130	0.000106		0.000144
4				PDDA+MM	20 (%)	0.001799	0.260187	0.000144	
Approximate Probabilities for Post Hoc Tests Error: Between MSE = 1.3843. df = 80.000									
Cell No.	Concentration P				{1} 4.1821	{2} 2.2921			
1	Low						0.000117		
2	High					0.000117			

## Appendix IV

Table IV.31: Newman-Keuls test. variable MOR Sc for interaction of factors AB with factorial ANOVA.

Cell No.	Approximate Probabilities for Post Hoc Tests Error: Between MSE = .63842. df = 75.000									
	Treatment Sc	Additives Sc	{1} 8.7000	{2} 7.7535	{3} 6.9821	{4} 4.9018	{5} 9.1490	{6} 8.1352	{7} 6.2654	{8} 5.9157
1	No treatment	SS		0.02107 0	0.00016 8	0.00012 5	0.19844 4	0.10692 3	0.00012 3	0.00012 6
2	No treatment	PDDA+MM	0.02107 0		0.02886 2	0.00012 3	0.00085 8	0.27348 9	0.00024 8	0.00015 3
3	Borax	SS	0.00016 8	0.02886 2		0.00014 9	0.00012 3	0.00387 9	0.04185 0	0.00810 4
4	Borax	PDDA+MM	0.00012 5	0.00012 3	0.00014 9		0.00012 1	0.00012 6	0.00062 6	0.00461 7
5	DSHP 77 g/l	SS	0.19844 4	0.00085 8	0.00012 3	0.00012 1		0.01243 0	0.00012 6	0.00012 5
6	DSHP 77 g/l	PDDA+MM	0.10692 3	0.27348 9	0.00387 9	0.00012 6	0.01243 0		0.00015 1	0.00012 3
7	DAHP 150 g/l	SS	0.00012 3	0.00024 8	0.04185 0	0.00062 6	0.00012 6	0.00015 1		0.31552 8
8	DAHP 150 g/l	PDDA+MM	0.00012 6	0.00015 3	0.00810 4	0.00461 7	0.00012 5	0.00012 3	0.31552 8	

Table IV.32: Newman-Keuls test. variable MOR Sc for interaction of factors AC with factorial ANOVA.

Cell No.	Approximate Probabilities for Post Hoc Tests Error: Between MSE = .63842. df = 75.000									
	Treatment Sc	Concentration Sc	{1} 7.6078	{2} 8.8457	{3} 3.7435	{4} 7.5613	{5} 6.5313	{6} 10.753	{7} 3.5002	{8} 8.6809
1	No treatment	Low		0.00184 4	0.00014 9	0.89335 9	0.00744 5	0.00014 9	0.00012 3	0.00285 9
2	No treatment	High	0.00184 4		0.00012 6	0.00227 6	0.00012 3	0.00011 5	0.00012 5	0.63545 3
3	Borax	Low	0.00014 9	0.00012 6		0.00011 0	0.00011 4	0.00012 5	0.48431 5	0.00012 3
4	Borax	High	0.89335 9	0.00227 6	0.00011 0		0.00405 5	0.00012 3	0.00014 9	0.00517 0
5	DSHP 77 g/l	Low	0.00744 5	0.00012 3	0.00011 4	0.00405 5		0.00012 6	0.00011 0	0.00014 9
6	DSHP 77 g/l	High	0.00014 9	0.00011 5	0.00012 5	0.00012 3	0.00012 6		0.00012 1	0.00011 0
7	DAHP 150 g/l	Low	0.00012 3	0.00012 5	0.48431 5	0.00014 9	0.00011 0	0.00012 1		0.00012 6
8	DAHP 150 g/l	High	0.00285 9	0.63545 3	0.00012 3	0.00517 0	0.00014 9	0.00011 0	0.00012 6	

Table IV.33: Newman-Keuls test. variable MOR Sc for interaction of factors BC with factorial ANOVA.

Cell No.	Newman-Keuls test; variable MOR Sc (Spreadsheet265) Approximate Probabilities for Post Hoc Tests Error: Between MSE = .63842. df = 75.000					
	Additives Sc	Concentration Sc	{1} 6.2127	{2} 9.3355	{3} 4.7237	{4} 8.5849
1	SS	Low			0.000110	0.000114
2	SS	High	0.000110			0.000149
3	PDDA+MM	Low	0.000114	0.000149		
4	PDDA+MM	High	0.000114	0.002665	0.000110	

## Appendix IV

Table IV.34: Newman-Keuls test. variable MOR Sc for interaction of factors ABC with factorial ANOVA.

Approximate Probabilities for Post Hoc Tests Error: Between MSE = .63842. df = 75.000																			
Cell No.	Treatment Sc	Additives Sc	Concentration Sc	{1} 9.54 95	{2} 7.85 05	{3} 5.66 62	{4} 9.84 08	{5} 3.74 35	{6} 10.2 21	{7} -- --	{8} 4.90 18	{9} 7.12 62	{10} 11.1 72	{11} 5.93 63	{12} 10.3 34	{13} 4.43 18	{14} 8.09 90	{15} 2.56 87	{16} 9.26 28
1	No treatment	SS	Low		0.00 2492	0.00 0125	0.52 9736	0.00 0161	0.31 8534		0.00 0121	0.00 0133	0.00 6604	0.00 0126	0.33 0528	0.00 0134	0.00 6778	0.00 0174	0.53 6331
2	No treatment	SS	High	0.00 2492		0.00 0199	0.00 0566	0.00 0125	0.00 0152		0.00 0123	0.12 0704	0.00 0121	0.00 0351	0.00 0138	0.00 0126	0.59 1810	0.00 0121	0.00 8591
3	No treatment	PDDA+MM	Low	0.00 0125	0.00 0199		0.00 0121	0.00 0587	0.00 0134		0.10 1842	0.00 6387	0.00 0174	0.55 9985	0.00 0161	0.02 4649	0.00 0132	0.00 0123	0.00 0126
4	No treatment	PDDA+MM	High	0.52 9736	0.00 0566	0.00 0121		0.00 0174	0.41 3049		0.00 0134	0.00 0127	0.02 5807	0.00 0125	0.53 5994	0.00 0161	0.00 1870	0.00 0117	0.42 6243
5	Borax	SS	Low	0.00 0161	0.00 0125	0.00 0587	0.00 0174		0.00 0117		0.03 7436	0.00 0126	0.00 0141	0.00 0203	0.00 0123	0.13 9968	0.00 0121	0.01 3033	0.00 0134
6	Borax	SS	High	0.31 8534	0.00 0152	0.00 0134	0.41 3049	0.00 0117			0.00 0161	0.00 0125	0.10 4920	0.00 0121	0.80 6430	0.00 0174	0.00 0269	0.00 0123	0.17 0379
7	Borax	PDDA+MM	Low																
8	Borax	PDDA+MM	High	0.00 0121	0.00 0123	0.10 1842	0.00 0134	0.03 7436	0.00 0161			0.00 0184	0.00 0117	0.07 0717	0.00 0174	0.31 1650	0.00 0126	0.00 0162	0.00 0125
9	DSHP 77 g/l	SS	Low	0.00 0133	0.12 0704	0.00 6387	0.00 0127	0.00 0126	0.00 0125		0.00 0184		0.00 0134	0.01 1971	0.00 0122	0.00 0124	0.09 4943	0.00 0125	0.00 0224
10	DSHP 77 g/l	SS	High	0.00 6604	0.00 0121	0.00 0174	0.02 5807	0.00 0141	0.10 4920		0.00 0117	0.00 0134		0.00 0161	0.07 3495	0.00 0123	0.00 0125	0.00 0148	0.00 1334
11	DSHP 77 g/l	PDDA+MM	Low	0.00 0126	0.00 0351	0.55 9985	0.00 0125	0.00 0203	0.00 0121		0.07 0717	0.01 1971	0.00 0161		0.00 0134	0.00 8971	0.00 0209	0.00 0126	0.00 0123
12	DSHP 77 g/l	PDDA+MM	High	0.33 0528	0.00 0138	0.00 0161	0.53 5994	0.00 0123	0.80 6430		0.00 0174	0.00 0122	0.07 3495	0.00 0134		0.00 0117	0.00 0211	0.00 0141	0.14 9385
13	DAHP 150 g/l	SS	Low	0.00 0134	0.00 0126	0.02 4649	0.00 0161	0.13 9968	0.00 0174		0.31 1650	0.00 0124	0.00 0123	0.00 8971	0.00 0117		0.00 0125	0.00 0468	0.00 0121
14	DAHP 150 g/l	SS	High	0.00 6778	0.59 1810	0.00 0132	0.00 1870	0.00 0121	0.00 0269		0.00 0126	0.09 4943	0.00 0125	0.00 0209	0.00 0211	0.00 0125		0.00 0134	0.01 3866
15	DAHP 150 g/l	PDDA+MM	Low	0.00 0174	0.00 0121	0.00 0123	0.00 0117	0.01 3033	0.00 0123		0.00 0162	0.00 0125	0.00 0148	0.00 0126	0.00 0141	0.00 0468	0.00 0134		0.00 0161
16	DAHP 150 g/l	PDDA+MM	High	0.53 6331	0.00 8591	0.00 0126	0.42 6243	0.00 0134	0.17 0379		0.00 0125	0.00 0224	0.00 1334	0.00 0123	0.14 9385	0.00 0121	0.01 3866	0.00 0161	

## Appendix IV

Table IV.35: Newman-Keuls test. variable Density Sc for interaction of factors AB with factorial ANOVA.

Cell No.	Approximate Probabilities for Post Hoc Tests Error: Between MSE = 2038.6. df = 75.000									
	Treatment Sc	Additives Sc	{1} 1299.3	{2} 1258.9	{3} 1203.0	{4} 1109.8	{5} 1328.1	{6} 1258.5	{7} 1290.9	{8} 1210.6
1	No treatment	SS		0.10403 8	0.00018 7	0.00012 5	0.14419 5	0.16774 8	0.66998 5	0.00030 8
2	No treatment	PDDA+MM	0.10403 8		0.02756 9	0.00012 3	0.00386 0	0.98548 2	0.10575 6	0.04120 3
3	Borax	SS	0.00018 7	0.02756 9		0.00012 2	0.00012 5	0.01585 1	0.00033 8	0.69889 5
4	Borax	PDDA+MM	0.00012 5	0.00012 3	0.00012 2		0.00012 1	0.00014 9	0.00012 6	0.00011 4
5	DSHP 77 g/l	SS	0.14419 5	0.00386 0	0.00012 5	0.00012 1		0.00578 4	0.14465 2	0.00012 7
6	DSHP 77 g/l	PDDA+MM	0.16774 8	0.98548 2	0.01585 1	0.00014 9	0.00578 4		0.22893 6	0.01656 9
7	DAHP 150 g/l	SS	0.66998 5	0.10575 6	0.00033 8	0.00012 6	0.14465 2	0.22893 6		0.00068 9
8	DAHP 150 g/l	PDDA+MM	0.00030 8	0.04120 3	0.69889 5	0.00011 4	0.00012 7	0.01656 9	0.00068 9	

Table IV.36: Newman-Keuls test. variable Density Sc for interaction of factors AC with factorial ANOVA.

Cell No.	Approximate Probabilities for Post Hoc Tests Error: Between MSE = 2038.6. df = 75.000									
	Treatment Sc	Concentration Sc	{1} 1311.8	{2} 1246.4	{3} 1113.5	{4} 1201.1	{5} 1262.8	{6} 1323.9	{7} 1182.7	{8} 1318.8
1	No treatment	Low		0.00374 9	0.00012 6	0.00014 9	0.01450 4	0.81005 0	0.00012 3	0.72199 4
2	No treatment	High	0.00374 9		0.00014 9	0.02332 3	0.40463 7	0.00165 9	0.00485 4	0.00235 6
3	Borax	Low	0.00012 6	0.00014 9		0.00018 0	0.00012 3	0.00012 1	0.00082 0	0.00012 5
4	Borax	High	0.00014 9	0.02332 3	0.00018 0		0.00655 9	0.00012 7	0.35035 0	0.00012 3
5	DSHP 77 g/l	Low	0.01450 4	0.40463 7	0.00012 3	0.00655 9		0.01331 1	0.00071 7	0.01498 5
6	DSHP 77 g/l	High	0.81005 0	0.00165 9	0.00012 1	0.00012 7	0.01331 1		0.00012 5	0.79407 9
7	DAHP 150 g/l	Low	0.00012 3	0.00485 4	0.00082 0	0.35035 0	0.00071 7	0.00012 5		0.00012 6
8	DAHP 150 g/l	High	0.72199 4	0.00235 6	0.00012 5	0.00012 3	0.01498 5	0.79407 9	0.00012 6	

Table IV.37: Newman-Keuls test. variable Density Sc for interaction of factors BC with factorial ANOVA.

Cell No.	Approximate Probabilities for Post Hoc Tests Error: Between MSE = 2038.6. df = 75.000					
	Additives Sc	Concentration Sc	{1} 1251.1	{2} 1309.6	{3} 1207.9	{4} 1235.5
1	SS	Low			0.000159	0.006036
2	SS	High	0.000159			0.000149
3	PDDA+MM	Low	0.006036	0.000149		
4	PDDA+MM	High	0.254422	0.000111	0.045481	

## Appendix IV

Table IV.38: Newman-Keuls test. variable Density Sc for interaction of factors ABC with factorial ANOVA.

Cell No.	Approximate Probabilities for Post Hoc Tests Error: Between MSE = 2038.6. df = 75.000																	
	Treatment Sc	Additives Sc	Concentration Sc	{1} 133 5.4	{2} 126 3.2	{3} 128 8.1	{4} 122 9.6	{5} 111 3.5	{6} 129 2.4	{7} 110 9.8	{8} 131 3.1	{9} 134 2.4	{10} 130 4.6	{11} 124 2.3	{12} 133 9.5	{13} 112 3.1	{14} 129 8.0	{15} 129 8.0
1	No treatment	SS	Low		0.095447	0.464238	0.003733	0.000117	0.471685	0.000123	0.396299	0.952740	0.000567	0.468765	0.013860	0.874734	0.000174	0.482024
2	No treatment	SS	High	0.095447		0.341040	0.407318	0.000128	0.503630	0.000126	0.399889	0.069650	0.217923	0.507940	0.426179	0.081155	0.000129	0.543183
3	No treatment	PDDA+MM	Low	0.464238	0.341040		0.120776	0.000125	0.870521	0.000122	0.872506	0.418818	0.037769	0.921345	0.190642	0.441681	0.000126	0.924549
4	No treatment	PDDA+MM	High	0.003733	0.407318	0.120776		0.000300	0.124381	0.000270	0.039777	0.002073	0.511440	0.073829	0.628481	0.002731	0.000413	0.104553
5	Borax	SS	Low	0.000117	0.000128	0.000125	0.000300		0.000122	0.886185	0.000174	0.000141	0.000957	0.000161	0.000160	0.000123	0.713504	0.000134
6	Borax	SS	High	0.471685	0.503630	0.870521	0.124381	0.000122		0.000134	0.856399	0.457642	0.034263	0.886221	0.227570	0.467616	0.000125	0.831246
7	Borax	PDDA+MM	Low															
8	Borax	PDDA+MM	High	0.000123	0.000126	0.000122	0.000270	0.886185	0.000134		0.000117	0.000148	0.000139	0.000174	0.000158	0.000141	0.865587	0.000161
9	DSHP 77 g/l	SS	Low	0.396299	0.399889	0.872506	0.039777	0.000174	0.856399	0.000117		0.659915	0.006966	0.744978	0.108053	0.571914	0.000161	0.830556
10	DSHP 77 g/l	SS	High	0.952740	0.069650	0.418818	0.002073	0.000141	0.457642	0.000148	0.659915		0.000324	0.580656	0.008386	0.890375	0.000123	0.515818
11	DSHP 77 g/l	PDDA+MM	Low	0.000567	0.217923	0.037769	0.511440	0.000957	0.034263	0.000139	0.000696	0.000324		0.015372	0.489165	0.000439	0.000122	0.025169
12	DSHP 77 g/l	PDDA+MM	High	0.468765	0.507940	0.921345	0.073829	0.000161	0.886221	0.000174	0.744978	0.580656	0.015372		0.172696	0.541781	0.000134	0.799745
13	DAHP 150 g/l	SS	Low	0.013860	0.426179	0.190642	0.628481	0.000160	0.227570	0.000158	0.108053	0.008386	0.489165	0.172696		0.010626	0.000245	0.215845
14	DAHP 150 g/l	SS	High	0.874734	0.081155	0.441681	0.002731	0.000123	0.467616	0.000141	0.571914	0.890375	0.000439	0.541781	0.010626		0.000117	0.506528
15	DAHP 150 g/l	PDDA+MM	Low	0.000174	0.000129	0.000126	0.000413	0.713504	0.000125	0.865587	0.000161	0.000123	0.000122	0.000134	0.000245	0.000117		0.000122
16	DAHP 150 g/l	PDDA+MM	High	0.482024	0.543183	0.924549	0.104553	0.000134	0.831246	0.000161	0.830556	0.515818	0.025169	0.799745	0.215845	0.506528	0.000122	

Table IV.39: Newman-Keuls test. variable IBS Sc for interaction of factors AB with factorial ANOVA.

Cell No.	Approximate Probabilities for Post Hoc Tests Error: Between MSE = .00212. df = 75.000									
	Treatment Sc	Additives Sc	{1} .44000	{2} .33083	{3} .42667	{4} .17833	{5} .44500	{6} .34250	{7} .30083	{8} .28667
1	No treatment	SS		0.000151	0.505788	0.000125	0.802753	0.000123	0.000123	0.000126
2	No treatment	PDDA+MM	0.000151		0.000129	0.000149	0.000124	0.560268	0.136667	0.075150
3	Borax	SS	0.505788	0.000129		0.000126	0.629728	0.000177	0.000149	0.000123

## Appendix IV

4	Borax	PDDA+MM	0.00012 5	0.00014 9	0.00012 6		0.00012 1	0.00012 3	0.00011 0	0.00011 5
5	DSHP 77 g/l	SS	0.80275 3	0.00012 4	0.62972 8	0.00012 1		0.00015 8	0.00012 6	0.00012 5
6	DSHP 77 g/l	PDDA+MM	0.00012 3	0.56026 8	0.00017 7	0.00012 3	0.00015 8		0.09882 6	0.03227 7
7	DAHP 150 g/l	SS	0.00012 3	0.13666 7	0.00014 9	0.00011 0	0.00012 6	0.09882 6		0.47964 3
8	DAHP 150 g/l	PDDA+MM	0.00012 6	0.07515 0	0.00012 3	0.00011 5	0.00012 5	0.03227 7	0.47964 3	

Table IV.40: Newman-Keuls test. variable IBS Sc for interaction of factors AC with factorial ANOVA.

Approximate Probabilities for Post Hoc Tests Error: Between MSE = .00212. df = 75.000										
Cell No.	Treatment Sc	Concentration Sc	{1} .39333	{2} .37750	{3} .26000	{4} .38583	{5} .26250	{6} .52500	{7} .13083	{8} .45667
1	No treatment	Low		0.70778 4	0.00012 3	0.70794 7	0.00014 9	0.00011 0	0.00012 6	0.00231 2
2	No treatment	High	0.70778 4		0.00011 0	0.67726 2	0.00011 4	0.00012 3	0.00014 9	0.00103 1
3	Borax	Low	0.00012 3	0.00011 0		0.00014 9	0.90064 5	0.00012 5	0.00011 4	0.00012 6
4	Borax	High	0.70794 7	0.67726 2	0.00014 9		0.00011 0	0.00014 9	0.00012 3	0.00198 7
5	DSHP 77 g/l	Low	0.00014 9	0.00011 4	0.90064 5	0.00011 0		0.00012 6	0.00011 0	0.00012 3
6	DSHP 77 g/l	High	0.00011 0	0.00012 3	0.00012 5	0.00014 9	0.00012 6		0.00012 1	0.00111 5
7	DAHP 150 g/l	Low	0.00012 6	0.00014 9	0.00011 4	0.00012 3	0.00011 0	0.00012 1		0.00012 5
8	DAHP 150 g/l	High	0.00231 2	0.00103 1	0.00012 6	0.00198 7	0.00012 3	0.00111 5	0.00012 5	

Table IV.41: Newman-Keuls test. variable IBS Sc for interaction of factors BC with factorial ANOVA.

Approximate Probabilities for Post Hoc Tests Error: Between MSE = .00212. df = 75.000						
Cell No.	Additives Sc	Concentration Sc	{1} .36417	{2} .44208	{3} .12556	{4} .43042
1	SS	Low		0.000110	0.000114	0.000121
2	SS	High	0.000110		0.000149	0.401836
3	PDDA+MM	Low	0.000114	0.000149		0.000110
4	PDDA+MM	High	0.000121	0.401836	0.000110	

## Appendix IV

Table IV.42: Newman-Keuls test. variable IBS Sc for interaction of factors ABC with factorial ANOVA.

Approximate Probabilities for Post Hoc Tests Error: Between MSE = .00212. df = 75.000																			
Cell No.	Treatment Sc	Additives Sc	Concentration Sc	{1} .650 00	{2} .230 00	{3} .136 67	{4} .525 00	{5} .260 00	{6} .593 33	{7} -- --	{8} .178 33	{9} .345 00	{10} .545 00	{11} .180 00	{12} .505 00	{13} .201 67	{14} .400 00	{15} .060 00	{16} .513 33
1	No treatment	SS	Low		0.00 0161	0.00 0141	0.00 0206	0.00 0134	0.03 6382		0.00 0123	0.00 0121	0.00 00610	0.00 0117	0.00 0133	0.00 0174	0.00 0125	0.00 0148	0.00 0139
2	No treatment	SS	High	0.00 0161		0.00 6714	0.00 0125	0.26 2729	0.00 0134		0.21 8937	0.00 0235	0.00 0121	0.15 1329	0.00 0123	0.28 9960	0.00 0149	0.00 0126	0.00 0126
3	No treatment	PDDA+MM	Low	0.00 0141	0.00 6714		0.00 0174	0.00 0321	0.00 0123		0.12 1308	0.00 0125	0.00 0117	0.23 9425	0.00 0134	0.07 7417	0.00 0121	0.00 5249	0.00 0161
4	No treatment	PDDA+MM	High	0.00 0206	0.00 0125	0.00 0174		0.00 0126	0.03 2241		0.00 0161	0.00 0123	0.45 4279	0.00 0134	0.73 3165	0.00 0121	0.00 0206	0.00 0117	0.66 2112
5	Borax	SS	Low	0.00 0134	0.26 2729	0.00 0321	0.00 0126		0.00 0121		0.02 4050	0.00 2180	0.00 0125	0.01 8391	0.00 0149	0.07 8731	0.00 0112	0.00 0125	0.00 0123
6	Borax	SS	High	0.03 6382	0.00 0134	0.00 0123	0.03 2241	0.00 0121			0.00 0117	0.00 0125	0.07 3102	0.00 0174	0.01 1782	0.00 0161	0.00 0126	0.00 0141	0.01 8391
7	Borax	PDDA+MM	Low																
8	Borax	PDDA+MM	High	0.00 0123	0.21 8937	0.12 1308	0.00 0161	0.02 4050	0.00 0117			0.00 0127	0.00 0174	0.95 0259	0.00 0121	0.65 5948	0.00 0125	0.00 0188	0.00 0134
9	DSHP 77 g/l	SS	Low	0.00 0121	0.00 0235	0.00 0125	0.00 0123	0.00 2180	0.00 0125		0.00 0127		0.00 0126	0.00 0123	0.00 0110	0.00 0152	0.04 2061	0.00 0121	0.00 0149
10	DSHP 77 g/l	SS	High	0.00 0610	0.00 0121	0.00 0117	0.45 4279	0.00 0125	0.07 3102		0.00 0174	0.00 0126		0.00 0161	0.43 9795	0.00 0134	0.00 0127	0.00 0123	0.46 2074
11	DSHP 77 g/l	PDDA+MM	Low	0.00 0117	0.15 1329	0.23 9425	0.00 0134	0.01 8391	0.00 0174		0.95 0259	0.00 0123	0.00 0161		0.00 0125	0.41 7720	0.00 0126	0.00 0268	0.00 0121
12	DSHP 77 g/l	PDDA+MM	High	0.00 0133	0.00 0123	0.00 0134	0.73 3165	0.00 0149	0.01 1782		0.00 0121	0.00 0110	0.43 9795	0.00 0125		0.00 0126	0.00 0281	0.00 0161	0.75 4891
13	DAHP 150 g/l	SS	Low	0.00 0174	0.28 9960	0.07 7417	0.00 0121	0.07 8731	0.00 0161		0.65 5948	0.00 0152	0.00 0134	0.41 7720	0.00 0126		0.00 0123	0.00 0130	0.00 0125
14	DAHP 150 g/l	SS	High	0.00 0125	0.00 0149	0.00 0121	0.00 0206	0.00 0112	0.00 0126		0.00 0125	0.04 2061	0.00 0127	0.00 0126	0.00 0281	0.00 0123		0.00 0134	0.00 0268
15	DAHP 150 g/l	PDDA+MM	Low	0.00 0148	0.00 0126	0.00 5249	0.00 0117	0.00 0125	0.00 0141		0.00 0188	0.00 0121	0.00 0123	0.00 0268	0.00 0161	0.00 0130	0.00 0134		0.00 0174
16	DAHP 150 g/l	PDDA+MM	High	0.00 0139	0.00 0126	0.00 0161	0.66 2112	0.00 0123	0.01 8391		0.00 0134	0.00 0149	0.46 2074	0.00 0121	0.75 4891	0.00 0125	0.00 0268	0.00 0174	

## Appendix IV

Table IV.43: Newman-Keuls test. variable TS Sc for interaction of factors AB with factorial ANOVA.

Cell No.	Approximate Probabilities for Post Hoc Tests Error: Between MSE = 2.5345. df = 75.000									
	Treatment Sc	Additives Sc	{1} 5.5517	{2} 4.2183	{3} 2.4942	{4} 5.8917	{5} 2.6333	{6} 5.4517	{7} 3.2550	{8} 4.2200
1	No treatment	SS		0.22280 5	0.00070 7	0.62343 2	0.00099 2	0.88513 6	0.01149 8	0.13697 2
2	No treatment	PDDA+MM	0.22280 5		0.06797 0	0.11938 6	0.06212 2	0.18027 6	0.16651 1	0.99817 5
3	Borax	SS	0.00070 7	0.06797 0		0.00023 4	0.84067 1	0.00083 4	0.51489 6	0.10080 0
4	Borax	PDDA+MM	0.62343 2	0.11938 6	0.00023 4		0.00032 4	0.79960 9	0.00362 8	0.08114 5
5	DSHP 77 g/l	SS	0.00099 2	0.06212 2	0.84067 1	0.00032 4		0.00110 1	0.37018 0	0.10687 5
6	DSHP 77 g/l	PDDA+MM	0.88513 6	0.18027 6	0.00083 4	0.79960 9	0.00110 1		0.01114 8	0.07813 1
7	DAHP 150 g/l	SS	0.01149 8	0.16651 1	0.51489 6	0.00362 8	0.37018 0	0.01114 8		0.34624 3
8	DAHP 150 g/l	PDDA+MM	0.13697 2	0.99817 5	0.10080 0	0.08114 5	0.10687 5	0.07813 1	0.34624 3	

Table IV.44: Newman-Keuls test. variable TS Sc for interaction of factors AC with factorial ANOVA.

Cell No.	Approximate Probabilities for Post Hoc Tests Error: Between MSE = 2.5345. df = 75.000									
	Treatment Sc	Concentration Sc	{1} 3.7117	{2} 6.0583	{3} 2.7867	{4} 4.0467	{5} 3.5617	{6} 4.5233	{7} 5.2050	{8} 2.2700
1	No treatment	Low		0.00927 1	0.37683 3	0.62854 0	0.82845 2	0.47033 7	0.14230 7	0.16543 8
2	No treatment	High	0.00927 1		0.00031 0	0.02361 5	0.00688 2	0.07328 3	0.21971 6	0.00013 2
3	Borax	Low	0.37683 3	0.00031 0		0.26863 7	0.26458 8	0.09727 3	0.00972 6	0.45604 2
4	Borax	High	0.62854 0	0.02361 5	0.26863 7		0.76221 6	0.49153 5	0.21950 2	0.08511 0
5	DSHP 77 g/l	Low	0.82845 2	0.00688 2	0.26458 8	0.76221 6		0.50648 7	0.13116 9	0.15351 0
6	DSHP 77 g/l	High	0.47033 7	0.07328 3	0.09727 3	0.49153 5	0.50648 7		0.32603 9	0.01964 2
7	DAHP 150 g/l	Low	0.14230 7	0.21971 6	0.00972 6	0.21950 2	0.13116 9	0.32603 9		0.00122 5
8	DAHP 150 g/l	High	0.16543 8	0.00013 2	0.45604 2	0.08511 0	0.15351 0	0.01964 2	0.00122 5	

Table IV.45: Newman-Keuls test. variable TS Sc for interaction of factors BC with factorial ANOVA.

Cell No.	Approximate Probabilities for Post Hoc Tests Error: Between MSE = 2.5345. df = 75.000						
	Additives Sc	Concentration Sc	{1} 2.3179	{2} 4.6492	{3} 6.1572	{4} 3.8000	
1	SS	Low			0.000124	0.000149	0.002884
2	SS	High		0.000124		0.002475	0.080016
3	PDDA+MM	Low		0.000149	0.002475		0.000121
4	PDDA+MM	High		0.002884	0.080016	0.000121	

## Appendix IV

Table IV.46: Newman-Keuls test. variable TS Sc for interaction of factors ABC with factorial ANOVA.

Approximate Probabilities for Post Hoc Tests Error: Between MSE = 2.5345. df = 75.000																			
Cell No.	Treatment Sc	Additives Sc	Concentration Sc	{1}	{2}	{3}	{4}	{5}	{6}	{7}	{8}	{9}	{10}	{11}	{12}	{13}	{14}	{15}	{16}
				2.1300	8.9733	5.2933	3.1433	2.7867	2.2017	5.8917	1.4833	3.7833	5.6400	5.2633	2.8717	3.6383	7.5383	.90167	
1	No treatment	SS	Low		0.000123	0.025187	0.804769	0.755825	0.938146		0.004865	0.484018	0.553136	0.009786	0.022382	0.851062	0.574545	0.000121	0.379780
2	No treatment	SS	High	0.000123		0.001432	0.000134	0.000174	0.000117		0.003650	0.000141	0.000129	0.002976	0.001855	0.000161	0.000124	0.122796	0.000148
3	No treatment	PDDA+MM	Low	0.025187	0.001432		0.144231	0.105750	0.025488		0.792479	0.003434	0.234321	0.707249	0.974146	0.101676	0.281257	0.077942	0.000563
4	No treatment	PDDA+MM	High	0.804769	0.000134	0.144231		0.920519	0.735751		0.055502	0.468284	0.766461	0.083991	0.105755	0.768504	0.591907	0.000323	0.197436
5	Borax	SS	Low	0.755825	0.000174	0.105750	0.920519		0.526540		0.030184	0.492318	0.814090	0.051922	0.088435	0.926663	0.790776	0.000228	0.252574
6	Borax	SS	High	0.938146	0.000117	0.025488	0.735751	0.526540			0.005243	0.715551	0.522732	0.010261	0.021927	0.747219	0.525558	0.000179	0.494553
7	Borax	PDDA+MM	Low																
8	Borax	PDDA+MM	High	0.004865	0.003650	0.792479	0.055502	0.030184	0.005243			0.000576	0.158453	0.785104	0.903112	0.031761	0.152306	0.077346	0.000163
9	DSHP 77 g/l	SS	Low	0.484018	0.000141	0.003434	0.468284	0.492318	0.715551		0.000576		0.210683	0.001198	0.003119	0.559099	0.237264	0.000123	0.528893
10	DSHP 77 g/l	SS	High	0.553136	0.000129	0.234321	0.766461	0.814090	0.522732		0.158453	0.210683		0.189951	0.111678	0.754573	0.875165	0.001577	0.058507
11	DSHP 77 g/l	PDDA+MM	Low	0.009786	0.002976	0.707249	0.083991	0.051922	0.010261		0.785104	0.001198	0.189951		0.911759	0.052465	0.199547	0.104164	0.000227
12	DSHP 77 g/l	PDDA+MM	High	0.022382	0.001855	0.974146	0.105755	0.088435	0.021927		0.903112	0.003119	0.111678	0.911759		0.080304	0.187472	0.107439	0.000526
13	DAHP 150 g/l	SS	Low	0.851062	0.000161	0.101676	0.768504	0.926663	0.747219		0.031761	0.559099	0.754573	0.052465	0.080304		0.683212	0.000212	0.276983
14	DAHP 150 g/l	SS	High	0.574545	0.000124	0.281257	0.591907	0.790776	0.525558		0.152306	0.237264	0.879547	0.197472	0.183212	0.68		0.001283	0.071980
15	DAHP 150 g/l	PDDA+MM	Low	0.000121	0.122796	0.077942	0.000323	0.000228	0.000179		0.077346	0.000123	0.001577	0.104164	0.107439	0.000212	0.001283		0.000141
16	DAHP 150 g/l	PDDA+MM	High	0.379780	0.000148	0.000563	0.197436	0.252574	0.494553		0.000163	0.528893	0.058507	0.000227	0.000526	0.276983	0.071980	0.000141	

## Appendix IV

Table IV.47: Newman-Keuls test. variable MOR P for interaction of factors AB with factorial ANOVA.

Cell No.	Approximate Probabilities for Post Hoc Tests Error: Between MSE = 1.3904. df = 80.000									
	Treatment P	Additives P	{1} 12.072	{2} 12.794	{3} 10.061	{4} 3.0083	{5} 7.2373	{6} 7.6196	{7} 4.7386	{8} 6.7777
1	No treatment	SS		0.13801 8	0.00018 7	0.00012 4	0.00014 7	0.00010 8	0.00012 5	0.00012 1
2	No treatment	PDDA+M M	0.13801 8		0.00010 9	0.00012 0	0.00012 1	0.00014 7	0.00012 4	0.00012 5
3	Borax	SS	0.00018 7	0.00010 9		0.00012 5	0.00010 8	0.00011 9	0.00012 1	0.00014 7
4	Borax	PDDA+M M	0.00012 4	0.00012 0	0.00012 5		0.00014 7	0.00012 1	0.00067 3	0.00010 8
5	DSHP 77 g/l	SS	0.00014 7	0.00012 1	0.00010 8	0.00014 7		0.42965 4	0.00011 2	0.34264 8
6	DSHP 77 g/l	PDDA+M M	0.00010 8	0.00014 7	0.00011 9	0.00012 1	0.42965 4		0.00014 7	0.19368 9
7	DAHP 150 g/l	SS	0.00012 5	0.00012 4	0.00012 1	0.00067 3	0.00011 2	0.00014 7		0.00017 3
8	DAHP 150 g/l	PDDA+M M	0.00012 1	0.00012 5	0.00014 7	0.00010 8	0.34264 8	0.19368 9	0.00017 3	

Table IV.48: Newman-Keuls test. variable MOR P for interaction of factors AC with factorial ANOVA.

Cell No.	Approximate Probabilities for Post Hoc Tests Error: Between MSE = 1.3904. df = 80.000									
	Treatment P	Concentration P	{1} 8.7050	{2} 16.161	{3} 4.5956	{4} 8.4737	{5} 4.8388	{6} 10.018	{7} 3.6617	{8} 7.8546
1	No treatment	Low		0.00010 8	0.00012 1	0.63227 0	0.00014 7	0.00795 7	0.00012 5	0.18751 0
2	No treatment	High	0.00010 8		0.00012 4	0.00014 7	0.00012 5	0.00011 7	0.00012 0	0.00012 1
3	Borax	Low	0.00012 1	0.00012 4		0.00014 7	0.61484 5	0.00012 5	0.05600 9	0.00010 8
4	Borax	High	0.63227 0	0.00014 7	0.00014 7		0.00010 8	0.00549 6	0.00012 1	0.20223 4
5	DSHP 77 g/l	Low	0.00014 7	0.00012 5	0.61484 5	0.00010 8		0.00012 1	0.04361 8	0.00011 7
6	DSHP 77 g/l	High	0.00795 7	0.00011 7	0.00012 5	0.00549 6	0.00012 1		0.00012 4	0.00026 8
7	DAHP 150 g/l	Low	0.00012 5	0.00012 0	0.05600 9	0.00012 1	0.04361 8	0.00012 4		0.00014 7
8	DAHP 150 g/l	High	0.18751 0	0.00012 1	0.00010 8	0.20223 4	0.00011 7	0.00026 8	0.00014 7	

Table IV.49: Newman-Keuls test. variable MOR P for interaction of factors BC with factorial ANOVA.

Cell No.	Approximate Probabilities for Post Hoc Tests Error: Between MSE = 1.3904. df = 80.000					
	Additives P	Concentration P	{1} 6.0816	{2} 10.973	{3} 4.8189	{4} 10.281
1	SS	Low		0.000108	0.000488	0.000117
2	SS	High	0.000108		0.000147	0.045408
3	PDDA+MM	Low	0.000488	0.000147		0.000108
4	PDDA+MM	High	0.000117	0.045408	0.000108	

## Appendix IV

Table IV.50: Newman-Keuls test. variable MOR P for interaction of factors ABC with factorial ANOVA.

Cell No.	Approximate Probabilities for Post Hoc Tests Error: Between MSE = 1.3904. df = 80.000																		
	Treatment P	Additives P	Concentration P	{1} 8.76 87	{2} 15.3 76	{3} 8.64 13	{4} 16.9 46	{5} 7.36 17	{6} 12.7 60	{7} 1.82 95	{8} 4.18 72	{9} 5.18 68	{10} 9.28 78	{11} 4.49 08	{12} 10.7 48	{13} 3.00 93	{14} 6.46 78	{15} 4.31 40	{16} 9.24 13
1	No treatment	SS	Low		0.00 012 5	0.85 220 8	0.00 012 4	0.10 342 4	0.00 012 2	0.00 015 8	0.00 012 0	0.00 013 0	0.72 697 5	0.00 012 5	0.02 394 5	0.00 013 2	0.00 615 7	0.00 012 4	0.48 963 4
2	No treatment	SS	High	0.00 012 5		0.00 012 4	0.02 377 9	0.00 012 0	0.00 035 2	0.00 014 6	0.00 013 3	0.00 015 8	0.00 014 7	0.00 017 7	0.00 010 8	0.00 014 0	0.00 013 2	0.00 011 9	0.00 012 1
3	No treatment	PDD A+M M	Low	0.85 220 8	0.00 012 4		0.00 012 0	0.06 390 1	0.00 012 5	0.00 013 2	0.00 012 4	0.00 015 8	0.77 821 6	0.00 012 1	0.02 223 0	0.00 012 0	0.00 576 0	0.00 012 5	0.65 366 5
4	No treatment	PDD A+M M	High	0.00 012 4	0.02 377 9	0.00 012 0		0.00 013 2	0.00 010 8	0.00 014 5	0.00 014 0	0.00 017 7	0.00 012 1	0.00 011 9	0.00 014 7	0.00 014 6	0.00 015 8	0.00 013 3	0.00 012 5
5	Borax	SS	Low	0.10 342 4	0.00 012 0	0.06 390 1	0.00 013 2		0.00 012 4	0.00 012 0	0.00 029 1	0.00 572 7	0.04 542 4	0.00 049 4	0.00 017 0	0.00 012 4	0.19 305 3	0.00 034 0	0.03 538 1
6	Borax	SS	High	0.00 012 2	0.00 035 2	0.00 012 5	0.00 010 8	0.00 012 4		0.00 014 0	0.00 011 9	0.00 013 2	0.00 011 3	0.00 015 8	0.00 424 0	0.00 013 3	0.00 012 0	0.00 017 7	0.00 015 4
7	Borax	PDD A+M M	Low	0.00 015 8	0.00 014 6	0.00 013 2	0.00 014 5	0.00 012 0	0.00 014 0		0.00 254 0	0.00 017 9	0.00 011 9	0.00 188 7	0.00 013 3	0.08 706 9	0.00 012 4	0.00 268 8	0.00 017 7
8	Borax	PDD A+M M	High	0.00 012 0	0.00 013 3	0.00 012 4	0.00 014 0	0.00 029 1	0.00 011 9	0.00 254 0		0.46 131 9	0.00 015 8	0.89 635 1	0.00 017 7	0.08 759 5	0.01 064 4	0.85 278 2	0.00 013 2
9	DSHP 77 g/l	SS	Low	0.00 013 0	0.00 015 8	0.00 015 8	0.00 017 7	0.00 572 7	0.00 013 2	0.00 017 9	0.46 131 9		0.00 012 4	0.30 979 5	0.00 012 0	0.01 657 4	0.06 363 2	0.40 945 7	0.00 012 5
10	DSHP 77 g/l	SS	High	0.72 697 5	0.00 014 7	0.77 821 6	0.00 012 1	0.04 542 4	0.00 011 3	0.00 011 9	0.00 015 8	0.00 012 4		0.00 012 0	0.03 505 3	0.00 017 7	0.00 125 9	0.00 013 2	0.94 579 9
11	DSHP 77 g/l	PDD A+M M	Low	0.00 012 5	0.00 017 7	0.00 012 1	0.00 011 9	0.00 049 4	0.00 015 8	0.00 188 7	0.89 635 1	0.30 979 5	0.00 012 0		0.00 013 2	0.13 885 4	0.01 316 3	0.79 583 6	0.00 012 4
12	DSHP 77 g/l	PDD A+M M	High	0.02 394 5	0.00 010 8	0.02 223 0	0.00 014 7	0.00 017 0	0.00 424 0	0.00 013 3	0.00 017 7	0.00 012 0	0.03 505 3	0.00 013 2		0.00 011 9	0.00 012 4	0.00 015 8	0.07 506 3
13	DAHP 150 g/l	SS	Low	0.00 013 2	0.00 014 0	0.00 012 0	0.00 014 6	0.00 012 4	0.00 013 3	0.08 706 9	0.08 759 5	0.01 657 4	0.00 017 7	0.13 885 4	0.00 011 9		0.00 015 4	0.14 076 0	0.00 015 8
14	DAHP 150 g/l	SS	High	0.00 615 7	0.00 013 2	0.00 576 0	0.00 015 8	0.19 305 3	0.00 012 0	0.00 012 4	0.01 064 4	0.06 363 2	0.00 125 9	0.01 316 3	0.00 012 4	0.00 015 4		0.01 168 0	0.00 110 2
15	DAHP 150 g/l	PDD A+M M	Low	0.00 012 4	0.00 011 9	0.00 012 5	0.00 013 3	0.00 034 0	0.00 017 7	0.00 268 8	0.85 278 2	0.40 945 7	0.00 013 2	0.79 583 6	0.00 015 8	0.14 076 0	0.01 168 0		0.00 012 0
16	DAHP 150 g/l	PDD A+M M	High	0.48 963 4	0.00 012 1	0.65 366 5	0.00 012 5	0.03 538 1	0.00 015 4	0.00 017 7	0.00 013 2	0.00 012 5	0.94 579 9	0.00 012 4	0.07 506 3	0.00 015 8	0.00 110 2	0.00 012 0	

## Appendix IV

Table IV.51: Newman-Keuls test. Variable Density P for interaction of factors AB with factorial ANOVA.

Cell No.	Approximate Probabilities for Post Hoc Tests Error: Between MSE = 3395.1. df = 80.000									
	Treatment P	Additives P	{1} 1287.5	{2} 1357.1	{3} 1253.3	{4} 1090.5	{5} 1256.6	{6} 1264.1	{7} 1173.4	{8} 1222.1
1	No treatment	SS		0.00457 1	0.48042 3	0.00012 4	0.40076 7	0.32981 9	0.00022 0	0.05610 5
2	No treatment	PDDA+M M	0.00457 1		0.00045 5	0.00012 0	0.00048 3	0.00066 1	0.00012 4	0.00012 7
3	Borax	SS	0.48042 3	0.00045 5		0.00014 7	0.88964 2	0.89183 0	0.00352 5	0.19434 7
4	Borax	PDDA+M M	0.00012 4	0.00012 0	0.00014 7		0.00012 1	0.00012 5	0.00092 5	0.00010 9
5	DSHP 77 g/l	SS	0.40076 7	0.00048 3	0.88964 2	0.00012 1		0.75224 7	0.00432 7	0.32139 5
6	DSHP 77 g/l	PDDA+M M	0.32981 9	0.00066 1	0.89183 0	0.00012 5	0.75224 7		0.00255 3	0.29766 6
7	DAHP 150 g/l	SS	0.00022 0	0.00012 4	0.00352 5	0.00092 5	0.00432 7	0.00255 3		0.04400 5
8	DAHP 150 g/l	PDDA+M M	0.05610 5	0.00012 7	0.19434 7	0.00010 9	0.32139 5	0.29766 6	0.04400 5	

Table IV.52: Newman-Keuls test. Variable Density P for interaction of factors AC with factorial ANOVA.

Cell No.	Approximate Probabilities for Post Hoc Tests Error: Between MSE = 3395.1. df = 80.000									
	Treatment P	Concentration P	{1} 1292.3	{2} 1352.3	{3} 1121.5	{4} 1222.3	{5} 1175.1	{6} 1345.6	{7} 1126.0	{8} 1269.6
1	No treatment	Low		0.03618 3	0.00012 5	0.01186 8	0.00016 8	0.02794 7	0.00012 1	0.34262 9
2	No treatment	High	0.03618 3		0.00012 0	0.00012 5	0.00012 5	0.77961 2	0.00012 4	0.00459 3
3	Borax	Low	0.00012 5	0.00012 0		0.00046 5	0.06819 4	0.00012 4	0.84974 7	0.00012 1
4	Borax	High	0.01186 8	0.00012 5	0.00046 5		0.05071 6	0.00015 4	0.00043 6	0.05052 1
5	DSHP 77 g/l	Low	0.00016 8	0.00012 5	0.06819 4	0.05071 6		0.00012 1	0.04216 9	0.00054 4
6	DSHP 77 g/l	High	0.02794 7	0.77961 2	0.00012 4	0.00015 4	0.00012 1		0.00012 5	0.00571 7
7	DAHP 150 g/l	Low	0.00012 1	0.00012 4	0.84974 7	0.00043 6	0.04216 9	0.00012 5		0.00014 7
8	DAHP 150 g/l	High	0.34262 9	0.00459 3	0.00012 1	0.05052 1	0.00054 4	0.00571 7	0.00014 7	

Table IV.53: Newman-Keuls test. Variable Density P for interaction of factors BC with factorial ANOVA.

Cell No.	Approximate Probabilities for Post Hoc Tests Error: Between MSE = 3395.1. df = 80.000					
	Additives P	Concentration P	{1} 1169.5	{2} 1315.9	{3} 1187.9	{4} 1279.0
1	SS	Low			0.000147	0.277761
2	SS	High	0.000147			0.000108
3	PDDA+MM	Low	0.277761	0.000108		
4	PDDA+MM	High	0.000108	0.031637	0.000118	

## Appendix IV

Table IV.54: Newman-Keuls test. Variable Density P for interaction of factors ABC with factorial ANOVA.

Cell No.	Approximate Probabilities for Post Hoc Tests Error: Between MSE = 3395.1. df = 80.000																		
	Treatment P	Additives P	Concentration P	{1} 124 6.3	{2} 132 8.6	{3} 133 8.3	{4} 137 6.0	{5} 122 2.9	{6} 128 3.7	{7} 102 0.0	{8} 116 1.0	{9} 115 1.4	{10} 136 1.8	{11} 119 8.9	{12} 132 9.4	{13} 105 7.5	{14} 128 9.4	{15} 119 4.5	{16} 124 9.8
1	No treatment	SS	Low		0.11 416 2	0.10 348 2	0.00 695 3	0.48 814 9	0.51 113 2	0.00 012 0	0.09 294 3	0.06 413 2	0.02 043 0	0.34 058 2	0.14 616 2	0.00 012 8	0.57 895 9	0.41 770 5	0.91 796 3
2	No treatment	SS	High	0.11 416 2		0.95 545 4	0.62 420 7	0.02 759 6	0.37 996 8	0.00 011 9	0.00 023 8	0.00 019 7	0.75 689 1	0.00 428 9	0.98 153 9	0.00 017 7	0.24 717 0	0.00 360 9	0.09 734 8
3	No treatment	PDD A+M	Low	0.10 348 2	0.95 545 4		0.50 445 0	0.02 062 1	0.48 718 1	0.00 014 0	0.00 022 4	0.00 014 2	0.48 617 8	0.00 269 7	0.79 214 0	0.00 013 3	0.47 010 3	0.00 213 8	0.10 212 7
4	No treatment	PDD A+M	High	0.00 695 3	0.62 420 7	0.50 445 0		0.00 087 3	0.10 085 6	0.00 014 5	0.00 013 3	0.00 014 0	0.67 529 4	0.00 022 5	0.51 243 4	0.00 014 6	0.11 579 5	0.00 015 9	0.00 774 5
5	Borax	SS	Low	0.48 814 9	0.02 759 6	0.02 062 1	0.00 087 3		0.27 811 7	0.00 012 4	0.26 284 2	0.21 936 6	0.00 282 2	0.47 769 6	0.03 431 3	0.00 018 3	0.28 731 7	0.67 620 3	0.70 410 3
6	Borax	SS	High	0.51 113 2	0.37 996 8	0.48 718 1	0.10 085 6	0.27 811 7		0.00 015 8	0.00 834 3	0.00 430 9	0.19 713 4	0.09 648 5	0.52 876 7	0.00 013 2	0.86 593 9	0.09 704 8	0.31 753 4
7	Borax	PDD A+M	Low	0.00 012 0	0.00 011 9	0.00 014 0	0.00 014 5	0.00 012 4	0.00 015 8		0.00 052 9	0.00 067 0	0.00 014 6	0.00 013 5	0.00 013 3	0.26 860 3	0.00 017 7	0.00 013 3	0.00 013 2
8	Borax	PDD A+M	High	0.09 294 3	0.00 023 8	0.00 022 4	0.00 013 3	0.26 284 2	0.00 834 3	0.00 052 9		0.77 512 3	0.00 012 2	0.50 118 6	0.00 027 7	0.00 808 3	0.00 629 6	0.32 327 3	0.09 977 9
9	DSHP 77 g/l	SS	Low	0.06 413 2	0.00 019 7	0.00 014 2	0.00 014 0	0.21 936 6	0.00 430 9	0.00 067 0	0.77 512 3		0.00 013 4	0.49 535 4	0.00 022 0	0.00 671 4	0.00 309 0	0.41 010 5	0.06 457 6
10	DSHP 77 g/l	SS	High	0.02 043 0	0.75 689 1	0.48 617 8	0.67 529 4	0.00 282 2	0.19 713 4	0.00 014 6	0.00 012 2	0.00 013 4		0.00 038 7	0.60 146 0	0.00 014 0	0.20 822 8	0.00 034 0	0.02 158 7
11	DSHP 77 g/l	PDD A+M	Low	0.34 058 2	0.00 428 9	0.00 269 7	0.00 022 5	0.47 769 6	0.09 648 5	0.00 013 5	0.50 118 6	0.49 535 4	0.00 038 7		0.00 513 8	0.00 074 5	0.08 878 7	0.89 566 8	0.43 425 5
12	DSHP 77 g/l	PDD A+M	High	0.14 616 2	0.98 153 9	0.79 214 0	0.51 243 4	0.03 431 3	0.52 876 7	0.00 013 3	0.00 027 7	0.00 022 0	0.60 146 0	0.00 513 8		0.00 011 9	0.46 304 1	0.00 417 5	0.13 589 1
13	DAHP 150 g/l	SS	Low	0.00 012 8	0.00 017 7	0.00 013 3	0.00 014 6	0.00 018 3	0.00 013 2	0.26 860 3	0.00 808 3	0.00 671 4	0.00 014 0	0.00 074 5	0.00 011 9		0.00 015 8	0.00 073 9	0.00 012 3
14	DAHP 150 g/l	SS	High	0.57 895 9	0.24 717 0	0.47 010 3	0.11 579 5	0.28 731 7	0.86 593 9	0.00 017 7	0.00 629 6	0.00 309 0	0.20 822 8	0.08 878 7	0.46 304 1	0.00 015 8		0.08 387 9	0.47 122 1
15	DAHP 150 g/l	PDD A+M	Low	0.41 770 5	0.00 360 9	0.00 213 8	0.00 015 9	0.67 620 3	0.09 704 8	0.00 013 3	0.32 327 3	0.41 010 5	0.00 034 0	0.89 566 8	0.00 417 5	0.00 073 9	0.08 387 9		0.47 345 7
16	DAHP 150 g/l	PDD A+M	High	0.91 796 3	0.09 734 8	0.10 212 7	0.00 774 5	0.70 410 3	0.31 753 4	0.00 013 2	0.09 977 9	0.06 457 6	0.02 158 7	0.43 425 5	0.13 589 1	0.00 012 3	0.47 122 1	0.47 345 7	

## Appendix IV

Table IV.55: Newman-Keuls test. Variable IBS P for interaction of factors AB with factorial ANOVA.

Cell No.	Approximate Probabilities for Post Hoc Tests Error: Between MSE = .00260. df = 80.000									
	Treatment P	Additives P	{1} .57333	{2} .44833	{3} .54333	{4} .34917	{5} .47500	{6} .33583	{7} .37667	{8} .45250
1	No treatment	SS		0.00012 1	0.15349 5	0.00012 4	0.00013 3	0.00012 0	0.00012 5	0.00014 7
2	No treatment	PDDA+M M	0.00012 1		0.00023 9	0.00012 9	0.40996 9	0.00014 9	0.00104 1	0.84195 5
3	Borax	SS	0.15349 5	0.00023 9		0.00012 5	0.00164 8	0.00012 4	0.00012 1	0.00021 1
4	Borax	PDDA+M M	0.00012 4	0.00012 9	0.00012 5		0.00012 1	0.52374 5	0.19029 1	0.00016 5
5	DSHP 77 g/l	SS	0.00013 3	0.40996 9	0.00164 8	0.00012 1		0.00012 5	0.00019 5	0.28304 2
6	DSHP 77 g/l	PDDA+M M	0.00012 0	0.00014 9	0.00012 4	0.52374 5	0.00012 5		0.12852 5	0.00012 3
7	DAHP 150 g/l	SS	0.00012 5	0.00104 1	0.00012 1	0.19029 1	0.00019 5	0.12852 5		0.00146 5
8	DAHP 150 g/l	PDDA+M M	0.00014 7	0.84195 5	0.00021 1	0.00016 5	0.28304 2	0.00012 3	0.00146 5	

Table IV.56: Newman-Keuls test. Variable IBS P for interaction of factors AC with factorial ANOVA.

Cell No.	Approximate Probabilities for Post Hoc Tests Error: Between MSE = .00260. df = 80.000									
	Treatment P	Concentration P	{1} .37917	{2} .64250	{3} .29667	{4} .59583	{5} .23167	{6} .57917	{7} .19500	{8} .63417
1	No treatment	Low		0.00012 1	0.00026 9	0.00010 8	0.00010 8	0.00011 7	0.00014 7	0.00014 7
2	No treatment	High	0.00012 1		0.00012 5	0.07039 1	0.00012 4	0.01650 7	0.00012 0	0.69008 4
3	Borax	Low	0.00026 9	0.00012 5		0.00014 7	0.00264 0	0.00010 8	0.00012 1	0.00012 1
4	Borax	High	0.00010 8	0.07039 1	0.00014 7		0.00012 1	0.42579 7	0.00012 5	0.06933 1
5	DSHP 77 g/l	Low	0.00010 8	0.00012 4	0.00264 0	0.00012 1		0.00014 7	0.08207 9	0.00012 5
6	DSHP 77 g/l	High	0.00011 7	0.01650 7	0.00010 8	0.42579 7	0.00014 7		0.00012 1	0.02658 2
7	DAHP 150 g/l	Low	0.00014 7	0.00012 0	0.00012 1	0.00012 5	0.08207 9	0.00012 1		0.00012 4
8	DAHP 150 g/l	High	0.00014 7	0.69008 4	0.00012 1	0.06933 1	0.00012 5	0.02658 2	0.00012 4	

Table IV.57: Newman-Keuls test. Variable IBS P for interaction of factors BC with factorial ANOVA.

Cell No.	Approximate Probabilities for Post Hoc Tests Error: Between MSE = .00260. df = 80.000					
	Additives P	Concentration P	{1} .33792	{2} .64625	{3} .21333	{4} .57958
1	SS	Low			0.000108	0.000117
2	SS	High	0.000108			0.000147
3	PDDA+MM	Low	0.000117	0.000147		
4	PDDA+MM	High	0.000117	0.000135	0.000108	

## Appendix IV

Table IV.58: Newman-Keuls test. Variable IBS P for interaction of factors ABC with factorial ANOVA.

Cell No.	Approximate Probabilities for Post Hoc Tests Error: Between MSE = .00260. df = 80.000																			
	Treatment P	Additives P	Concentration P	{1} .478 33	{2} .668 33	{3} .280 00	{4} .616 67	{5} .341 67	{6} .745 00	{7} .251 67	{8} .446 67	{9} .365 00	{10} .585 00	{11} .098 33	{12} .573 33	{13} .166 67	{14} .586 67	{15} .223 33	{16} .681 67	
1	No treatment	SS	Low		0.00 012 5	0.00 012 1	0.00 021 2	0.00 021 4	0.00 012 0	0.00 012 5	0.28 534 7	0.00 078 4	0.00 155 5	0.00 013 2	0.00 196 4	0.00 012 0	0.00 243 3	0.00 012 4	0.00 012 4	
2	No treatment	SS	High	0.00 012 5		0.00 015 8	0.08 317 1	0.00 013 2	0.02 931 2	0.00 017 7	0.00 012 4	0.00 012 0	0.02 944 9	0.00 014 0	0.01 525 1	0.00 013 3	0.01 877 9	0.00 011 9	0.65 192 2	
3	No treatment	PDD A+M M	Low	0.00 012 1	0.00 015 8		0.00 013 2	0.03 942 6	0.00 011 9	0.33 880 4	0.00 014 8	0.01 378 3	0.00 012 4	0.00 012 1	0.00 012 5	0.00 143 4	0.00 012 0	0.13 834 9	0.00 017 7	
4	No treatment	PDD A+M M	High	0.00 021 2	0.08 317 1	0.00 013 2		0.00 012 0	0.00 035 0	0.00 015 8	0.00 012 6	0.00 012 4	0.53 187 8	0.00 013 3	0.45 906 2	0.00 011 9	0.31 128 7	0.00 017 7	0.07 597 7	
5	Borax	SS	Low	0.00 021 4	0.00 013 2	0.03 942 6	0.00 012 0		0.00 017 7	0.00 853 9	0.00 184 9	0.43 044 3	0.00 012 5	0.00 012 5	0.00 012 1	0.00 012 1	0.00 012 4	0.00 085 7	0.00 015 8	
6	Borax	SS	High	0.00 012 0	0.02 931 2	0.00 011 9	0.00 035 0	0.00 017 7		0.00 013 3	0.00 013 2	0.00 015 8	0.00 013 1	0.00 014 5	0.00 012 5	0.00 014 6	0.00 012 6	0.00 014 6	0.00 014 0	0.03 453 8
7	Borax	PDD A+M M	Low	0.00 012 5	0.00 017 7	0.33 880 4	0.00 015 8	0.00 853 9	0.00 013 3		0.00 012 1	0.00 143 4	0.00 012 0	0.00 015 3	0.00 012 4	0.01 378 3	0.00 013 2	0.33 880 4	0.00 011 9	
8	Borax	PDD A+M M	High	0.28 534 7	0.00 012 4	0.00 014 8	0.00 012 6	0.00 184 9	0.00 013 2	0.00 012 1		0.00 700 4	0.00 020 0	0.00 012 0	0.00 023 7	0.00 012 4	0.00 019 4	0.00 012 5	0.00 012 9	0.00 012 0
9	DSHP 77 g/l	SS	Low	0.00 078 4	0.00 012 0	0.01 378 3	0.00 044 3	0.43 015 8	0.00 143 4	0.00 700 4		0.00 012 1	0.00 012 4	0.00 014 7	0.00 012 5	0.00 012 5	0.00 017 9	0.00 017 9	0.00 013 2	
10	DSHP 77 g/l	SS	High	0.00 155 5	0.02 944 9	0.00 012 4	0.53 187 8	0.00 012 5	0.00 013 1	0.00 012 0	0.00 020 0	0.00 012 1		0.00 017 7	0.69 303 7	0.00 015 8	0.95 508 8	0.00 013 2	0.01 293 6	
11	DSHP 77 g/l	PDD A+M M	Low	0.00 013 2	0.00 014 0	0.00 012 1	0.00 013 3	0.00 012 5	0.00 014 5	0.00 015 3	0.00 012 0	0.00 012 4	0.00 017 7		0.00 015 8	0.02 291 9	0.00 011 8	0.00 026 8	0.00 014 6	
12	DSHP 77 g/l	PDD A+M M	High	0.00 196 4	0.01 525 1	0.00 012 5	0.45 906 2	0.00 012 1	0.00 012 5	0.00 012 4	0.00 023 7	0.00 014 7	0.69 303 7	0.00 015 8		0.00 013 2	0.89 329 7	0.00 012 0	0.00 556 7	
13	DAHP 150 g/l	SS	Low	0.00 012 0	0.00 013 3	0.00 143 4	0.00 011 9	0.00 012 1	0.00 014 6	0.01 378 3	0.00 012 4	0.00 012 5	0.00 015 8	0.02 291 2	0.00 013 2		0.00 017 7	0.05 788 0	0.00 014 0	
14	DAHP 150 g/l	SS	High	0.00 243 3	0.01 877 9	0.00 012 0	0.31 128 7	0.00 012 4	0.00 012 6	0.00 013 2	0.00 019 4	0.00 012 5	0.95 508 8	0.00 011 9	0.89 329 7	0.00 017 7		0.00 015 8	0.00 970 5	
15	DAHP 150 g/l	PDD A+M M	Low	0.00 012 4	0.00 011 9	0.13 834 9	0.00 017 7	0.00 085 7	0.00 014 0	0.33 880 4	0.00 012 5	0.00 017 9	0.00 013 2	0.00 026 8	0.00 012 0	0.05 788 0	0.00 015 8		0.00 013 3	
16	DAHP 150 g/l	PDD A+M M	High	0.00 012 4	0.65 192 2	0.00 017 7	0.07 597 7	0.00 015 8	0.03 453 8	0.00 011 9	0.00 012 0	0.00 013 2	0.01 293 6	0.00 014 6	0.00 556 7	0.00 014 0	0.00 970 5	0.00 013 3		

## Appendix IV

Table IV.59: Newman-Keuls test. Variable TS P for interaction of factors AB with factorial ANOVA.

Cell No.	Approximate Probabilities for Post Hoc Tests Error: Between MSE = 1.3843. df = 80.000									
	Treatment P	Additives P	{1} 4.0558	{2} 4.8250	{3} 2.6125	{4} 2.1375	{5} 3.7358	{6} 4.4967	{7} 1.3250	{8} 2.7083
1	No treatment	SS		0.25108 0	0.01834 8	0.00141 7	0.50731 6	0.36161 1	0.00012 7	0.01727 1
2	No treatment	PDDA+M M	0.25108 0		0.00033 0	0.00012 8	0.11447 5	0.49635 4	0.00012 0	0.00040 7
3	Borax	SS	0.01834 8	0.00033 0		0.32579 9	0.05629 3	0.00180 9	0.02407 8	0.84247 3
4	Borax	PDDA+M M	0.00141 7	0.00012 8	0.32579 9		0.00721 0	0.00018 4	0.09474 3	0.46356 9
5	DSHP 77 g/l	SS	0.50731 6	0.11447 5	0.05629 3	0.00721 0		0.25850 2	0.00014 6	0.03556 0
6	DSHP 77 g/l	PDDA+M M	0.36161 1	0.49635 4	0.00180 9	0.00018 4	0.25850 2		0.00012 4	0.00212 8
7	DAHP 150 g/l	SS	0.00012 7	0.00012 0	0.02407 8	0.09474 3	0.00014 6	0.00012 4		0.02582 5
8	DAHP 150 g/l	PDDA+M M	0.01727 1	0.00040 7	0.84247 3	0.46356 9	0.03556 0	0.00212 8	0.02582 5	

Table IV.60: Newman-Keuls test. Variable TS P for interaction of factors AC with factorial ANOVA.

Cell No.	Approximate Probabilities for Post Hoc Tests Error: Between MSE = 1.3843. df = 80.000									
	Treatment P	Concentration P	{1} 5.7942	{2} 3.0867	{3} 2.8008	{4} 1.9492	{5} 4.8292	{6} 3.4033	{7} 3.3042	{8} .72917
1	No treatment	Low		0.00012 3	0.00012 5	0.00012 4	0.04799 6	0.00011 7	0.00015 4	0.00012 0
2	No treatment	High	0.00012 3		0.55358 2	0.05250 6	0.00287 5	0.78773 4	0.65202 4	0.00017 0
3	Borax	Low	0.00012 5	0.55358 2		0.08014 2	0.00070 1	0.59449 8	0.54916 4	0.00023 3
4	Borax	High	0.00012 4	0.05250 6	0.08014 2		0.00012 5	0.02678 9	0.03023 7	0.01313 0
5	DSHP 77 g/l	Low	0.04799 6	0.00287 5	0.00070 1	0.00012 5		0.00408 3	0.00606 6	0.00012 4
6	DSHP 77 g/l	High	0.00011 7	0.78773 4	0.59449 8	0.02678 9	0.00408 3		0.83706 5	0.00012 8
7	DAHP 150 g/l	Low	0.00015 4	0.65202 4	0.54916 4	0.03023 7	0.00606 6	0.83706 5		0.00012 7
8	DAHP 150 g/l	High	0.00012 0	0.00017 0	0.00023 3	0.01313 0	0.00012 4	0.00012 8	0.00012 7	

Table IV.61: Newman-Keuls test. Variable TS P for interaction of factors BC with factorial ANOVA.

Cell No.	Approximate Probabilities for Post Hoc Tests Error: Between MSE = 1.3843. df = 80.000					
	Additives P	Concentration P	{1} 3.3688	{2} 2.4958	{3} 4.9954	{4} 2.0883
1	SS	Low			0.012131	0.000123
2	SS	High	0.012131			0.000108
3	PDDA+MM	Low	0.000123	0.000108		
4	PDDA+MM	High	0.000994	0.233839	0.000147	

## Appendix IV

Table IV.62: Newman-Keuls test. Variable TS P for interaction of factors ABC with factorial ANOVA.

Cell No.	Approximate Probabilities for Post Hoc Tests Error: Between MSE = 1.3843. df = 80.000																		
	Treatment P	Additives P	Concentration P	{1} 4.7783	{2} 3.3333	{3} 6.8100	{4} 2.8400	{5} 2.6150	{6} 2.6100	{7} 2.9867	{8} 1.2883	{9} 4.1200	{10} 3.3517	{11} 5.5383	{12} 3.4550	{13} 1.9617	{14} .68833	{15} 4.6467	{16} .77000
1	No treatment	SS	Low		0.284165	0.010319	0.096545	0.050539	0.059213	0.128711	0.000227	0.598466	0.230227	0.266643	0.216635	0.003907	0.000142	0.846904	0.000137
2	No treatment	SS	High	0.284165		0.000167	0.748753	0.716247	0.823918	0.611327	0.051947	0.654886	0.978638	0.027378	0.982559	0.340902	0.006102	0.308502	0.007183
3	No treatment	PDD A+M	Low	0.010319	0.000167		0.000161	0.000178	0.000120	0.000103	0.000149	0.000161	0.000157	0.064957	0.000178	0.000103	0.000135	0.010989	0.000146
4	No treatment	PDD A+M	High	0.096545	0.748753	0.000167		0.741466	0.938896	0.829716	0.160845	0.419311	0.875098	0.004725	0.894097	0.570108	0.034071	0.122472	0.035734
5	Borax	SS	Low	0.050539	0.716247	0.000178	0.741466		0.994236	0.848294	0.214691	0.299083	0.814054	0.001945	0.817598	0.603094	0.062002	0.068729	0.060435
6	Borax	SS	High	0.059213	0.823918	0.000120	0.938896	0.994236		0.945135	0.132767	0.349600	0.883311	0.002271	0.874638	0.342861	0.045462	0.082007	0.040462
7	Borax	PDD A+M	Low	0.128711	0.611327	0.000197	0.829716	0.848294	0.945135		0.136445	0.459190	0.853257	0.007587	0.900920	0.559847	0.023577	0.154019	0.026072
8	Borax	PDD A+M	High	0.000227	0.050539	0.000149	0.160845	0.210137	0.132767	0.136445		0.003038	0.060961	0.000134	0.049878	0.324668	0.652435	0.000361	0.447802
9	DSHP 77 g/l	SS	Low	0.598466	0.654886	0.000161	0.419311	0.299083	0.349600	0.459190	0.0003038		0.497974	0.165933	0.330658	0.051546	0.000270	0.440564	0.000371
10	DSHP 77 g/l	SS	High	0.230227	0.978638	0.000178	0.875098	0.814054	0.883311	0.850967	0.067971	0.497974		0.022194	0.879561	0.394605	0.006823	0.233664	0.008228
11	DSHP 77 g/l	PDD A+M	Low	0.266643	0.027378	0.064957	0.0004725	0.0001945	0.0002271	0.0007584	0.0001374	0.165933	0.022194		0.024027	0.000184	0.000146	0.392441	0.000140
12	DSHP 77 g/l	PDD A+M	High	0.216635	0.982559	0.000178	0.894097	0.817598	0.879716	0.900920	0.049878	0.330658	0.879561	0.024027		0.363956	0.004974	0.191787	0.006155
13	DAHP 150 g/l	SS	Low	0.0003907	0.340902	0.000135	0.570103	0.600309	0.342861	0.559847	0.324668	0.051546	0.394605	0.000184	0.363956		0.247265	0.006155	0.191787
14	DAHP 150 g/l	SS	High	0.000146	0.0006105	0.000146	0.034071	0.062002	0.045462	0.027378	0.652435	0.000270	0.0006823	0.000146	0.0004974	0.247265		0.000137	0.904707
15	DAHP 150 g/l	PDD A+M	Low	0.846904	0.308502	0.010989	0.122472	0.060435	0.082007	0.154019	0.000361	0.440564	0.230227	0.394605	0.191787	0.0006155	0.000137		0.000137
16	DAHP 150 g/l	PDD A+M	High	0.000137	0.0007183	0.000146	0.035734	0.060435	0.040462	0.026072	0.440564	0.000371	0.0008228	0.000146	0.0006155	0.191787	0.904707	0.000137	

## Appendix IV

### 2. Non combustibility test statistical analysis:

Table IV.63: SS Whole Model vs. SS Residual for One way ANOVA.

	Multiple R	Multiple R <sup>2</sup>	Adjusted R <sup>2</sup>	SS Model	df Model	MS Model	SS Residual	df Residual	MS Residual	F	p
ΔT SC	0.817079	0.667618	0.596393	1868.319	6	311.3866	930.1677	28	33.22027	9.373390	0.000011
Δ T P	0.960244	0.922068	0.905020	6659.699	7	951.3856	562.8720	32	17.58975	54.08750	0.000000

Table IV.64: Homogeneity of variances for One way ANOVA.

	Levene's Test for Homogeneity of Variances				Tests of Homogeneity of Variances				
	MS Effect	MS Error	F	P	Hartley F-max	Cochran C	Bartlett Chi-Sqr.	df	P
ΔT SC	32.35046	11.65092	2.776645	0.030209	93.00504	0.714710	23.35858	6	0.000685
Δ T P	3.480223	3.924240	0.886853	0.528014	4.606517	0.226041	3.698896	7	0.813732

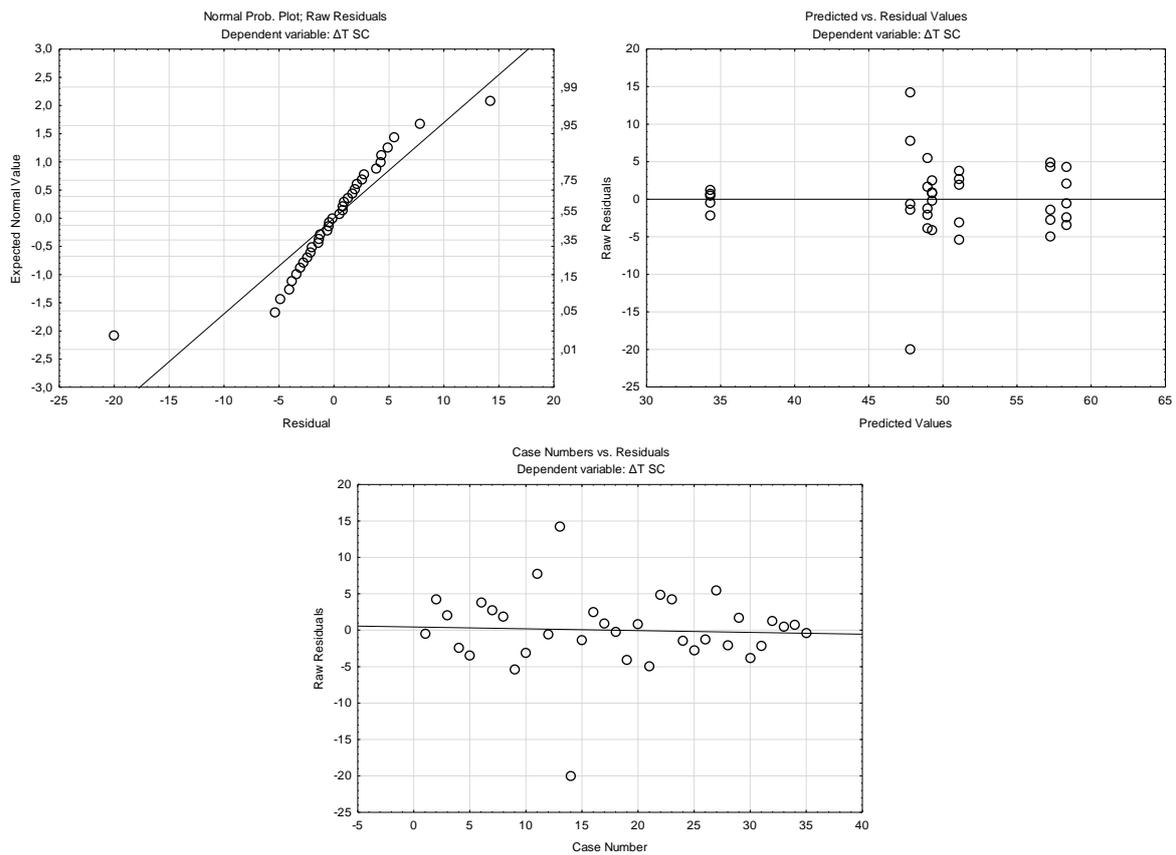


Figure IV.30: The normality of the distribution of residuals for ΔT Sc of One way ANOVA

# Appendix IV

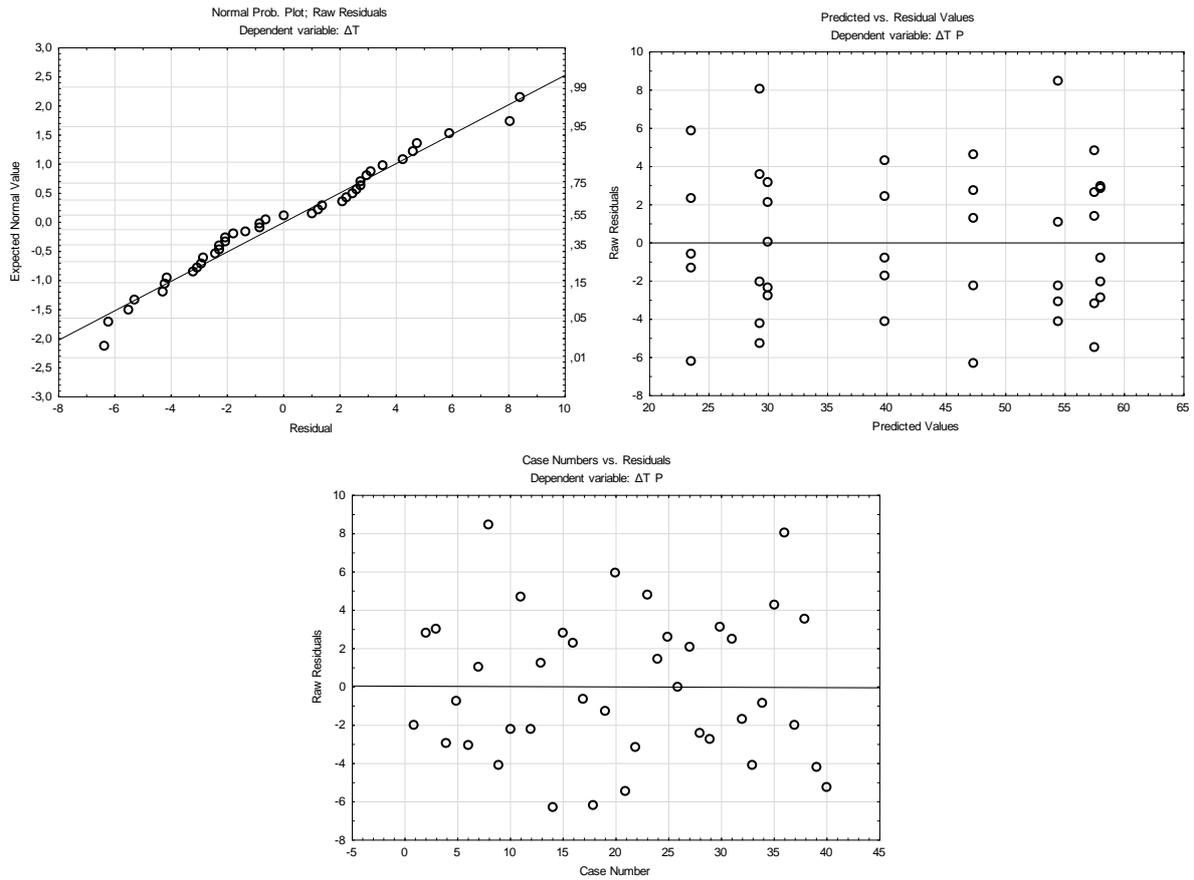


Figure IV.31: The normality of the distribution of residuals for  $\Delta T P$  of One way ANOVA

Table IV.65: LSD test. Variable  $\Delta T SC$  for Board Type Sc with One way ANOVA.

Cell No.	LSD test; variable $\Delta T SC$ (fire test one way anova) Probabilities for Post Hoc Tests Error: Between MSE = 33.220. df = 28.000							
	Board Type Sc	{1} 58.320	{2} 51.080	{3} 47.800	{4} 49.280	{5} 57.228	{6} 48.940	{7} 34.320
1	N SC Wg		0.056888	0.007434	0.019425	0.766722	0.015665	0.000000
2	borax SC Wg	0.056888		0.375905	0.625307	0.102800	0.561868	0.000083
3	DS 77g/l SC Wg	0.007434	0.375905		0.687826	0.015192	0.756801	0.000939
4	DA 150g/l SC Wg	0.019425	0.625307	0.687826		0.037795	0.926352	0.000318
5	N SC PDDA+MM	0.766722	0.102800	0.015192	0.037795		0.030854	0.000001
6	DS 77g/l SC PDDA+MM	0.015665	0.561868	0.756801	0.926352	0.030854		0.000408
7	DA 150g/l SC PDDA+MM	0.000000	0.000083	0.000939	0.000318	0.000001	0.000408	

## Appendix IV

Table IV.66: Scheffe test. Variable  $\Delta T$  SC for Board Type Sc with One way ANOVA.

Cell No.	Scheffe test; variable $\Delta T$ SC (fire test one way anova) Probabilities for Post Hoc Tests Error: Between MSE = 33.220. df = 28.000							
	Board Type Sc	{1} 58.320	{2} 51.080	{3} 47.800	{4} 49.280	{5} 57.228	{6} 48.940	{7} 34.320
1	N SC Wg		0.684080	0.253966	0.429795	0.999982	0.385043	0.000099
2	borax SC Wg	0.684080		0.990555	0.999669	0.821691	0.999106	0.010063
3	DS 77g/l SC Wg	0.253966	0.990555		0.999894	0.378907	0.999977	0.064545
4	DA 150g/l SC Wg	0.429795	0.999669	0.999894		0.583684	1.000000	0.028858
5	N SC PDDA+MM	0.999982	0.821691	0.378907	0.583684		0.534824	0.000202
6	DS 77g/l SC PDDA+MM	0.385043	0.999106	0.999977	1.000000	0.534824		0.034914
7	DA 150g/l SC PDDA+MM	0.000099	0.010063	0.064545	0.028858	0.000202	0.034914	

Table IV.67: Newman-Keuls test. Variable  $\Delta T$  SC for Board Type Sc with One way ANOVA.

Cell No.	Newman-Keuls test; variable $\Delta T$ SC (fire test one way anova) Approximate Probabilities for Post Hoc Tests Error: Between MSE = 33.220. df = 28.000							
	Board Type Sc	{1} 58.320	{2} 51.080	{3} 47.800	{4} 49.280	{5} 57.228	{6} 48.940	{7} 34.320
1	N SC Wg		0.134416	0.072621	0.085358	0.766850	0.103216	0.000149
2	borax SC Wg	0.134416		0.805058	0.625439	0.102954	0.828205	0.000850
3	DS 77g/l SC Wg	0.072621	0.805058		0.913503	0.100499	0.756929	0.001081
4	DA 150g/l SC Wg	0.085358	0.625439	0.913503		0.092304	0.926457	0.001820
5	N SC PDDA+MM	0.766850	0.102954	0.100499	0.092304		0.128728	0.000141
6	DS 77g/l SC PDDA+MM	0.103216	0.828205	0.756929	0.926457	0.128728		0.001256
7	DA 150g/l SC PDDA+MM	0.000149	0.000850	0.001081	0.001820	0.000141	0.001256	

Table IV.68: LSD test. Variable  $\Delta T$  P for Board Type P with One way ANOVA.

Cell No.	LSD test; variable $\Delta T$ P (fire test one way anova) Probabilities for Post Hoc Tests Error: Between MSE = 17.590. df = 32.000								
	Board Type P	{1} 58.120	{2} 54.460	{3} 47.360	{4} 23.520	{5} 57.520	{6} 30.000	{7} 39.940	{8} 29.360
1	N P Wg		0.177209	0.000299	0.000000	0.822485	0.000000	0.000000	0.000000
2	borax P Wg	0.177209		0.011628	0.000000	0.257201	0.000000	0.000005	0.000000
3	DS 77g/l P Wg	0.000299	0.011628		0.000000	0.000563	0.000000	0.008649	0.000000
4	DA 150g/l P Wg	0.000000	0.000000	0.000000		0.000000	0.020268	0.000001	0.035016
5	N P PDDA+MM	0.822485	0.257201	0.000563	0.000000		0.000000	0.000000	0.000000
6	borax P PDDA+MM	0.000000	0.000000	0.000000	0.020268	0.000000		0.000708	0.810878
7	DS 77g/l P PDDA+MM	0.000000	0.000005	0.008649	0.000001	0.000000	0.000708		0.000362
8	DA 150g/l P PDDA+MM	0.000000	0.000000	0.000000	0.035016	0.000000	0.810878	0.000362	

## Appendix IV

Table IV.69: Scheffe test. Variable  $\Delta T P$  for Board Type P with One way ANOVA.

Cell No.	Scheffe test; variable $\Delta T P$ (fire test one way anova) Probabilities for Post Hoc Tests Error: Between MSE = 17.590. df = 32.000								
	Board Type P	{1} 58.120	{2} 54.460	{3} 47.360	{4} 23.520	{5} 57.520	{6} 30.000	{7} 39.940	{8} 29.360
1	N P Wg		0.960389	0.046813	0.000000	1.000000	0.000000	0.000064	0.000000
2	borax P Wg	0.960389		0.434013	0.000000	0.985473	0.000000	0.001944	0.000000
3	DS 77g/l P Wg	0.046813	0.434013		0.000000	0.072845	0.000138	0.376297	0.000075
4	DA 150g/l P Wg	0.000000	0.000000	0.000000		0.000000	0.553312	0.000334	0.677733
5	N P PDDA+MM	1.000000	0.985473	0.072845	0.000000		0.000000	0.000112	0.000000
6	borax P PDDA+MM	0.000000	0.000000	0.000138	0.553312	0.000000		0.085128	1.000000
7	DS 77g/l P PDDA+MM	0.000064	0.001944	0.376297	0.000334	0.000112	0.085128		0.053589
8	DA 150g/l P PDDA+MM	0.000000	0.000000	0.000075	0.677733	0.000000	1.000000	0.053589	

Table IV.70: Newman-Keuls test. Variable  $\Delta T P$  for Board Type P with One way ANOVA.

Cell No.	Newman-Keuls test; variable $\Delta T P$ (fire test one way anova) Approximate Probabilities for Post Hoc Tests Error: Between MSE = 17.590. df = 32.000								
	Board Type P	{1} 58.120	{2} 54.460	{3} 47.360	{4} 23.520	{5} 57.520	{6} 30.000	{7} 39.940	{8} 29.360
1	N P Wg		0.363300	0.001736	0.000138	0.822608	0.000131	0.000131	0.000137
2	borax P Wg	0.363300		0.011761	0.000131	0.257310	0.000165	0.000134	0.000131
3	DS 77g/l P Wg	0.001736	0.011761		0.000131	0.001687	0.000123	0.008791	0.000165
4	DA 150g/l P Wg	0.000138	0.000131	0.000131		0.000137	0.051714	0.000167	0.035136
5	N P PDDA+MM	0.822608	0.257310	0.001687	0.000137		0.000131	0.000165	0.000131
6	borax P PDDA+MM	0.000131	0.000165	0.000123	0.051714	0.000131		0.000837	0.810997
7	DS 77g/l P PDDA+MM	0.000131	0.000134	0.008791	0.000167	0.000165	0.000837		0.001131
8	DA 150g/l P PDDA+MM	0.000137	0.000131	0.000165	0.035136	0.000131	0.810997	0.001131	

Table IV.71: SS Whole Model vs. SS Residual for Main ANOVA.

main anova	Multip le R	Multip le R2	Adjust ed R2	SS Model	df Mod el	MS Model	SS Residu al	df Resid ual	MS Residu al	F	p
$\Delta T$ Sc	0.7291 62	0.5316 77	0.4692 34	1487.8 92	4	371.97 29	1310.5 95	30	43.686 51	8.5145 94	0.0001 03
$\Delta T P$	0.8633 67	0.7454 02	0.7163 05	5383.7 21	4	1345.9 30	1838.8 50	35	52.538 57	25.617 95	0.0000 00

Table IV.72: SS Whole Model vs. SS Residual for Factorial ANOVA.

factor anova	Multip le R	Multip le R2	Adjust ed R2	SS Model	df Mod el	MS Model	SS Residu al	df Resid ual	MS Residu al	F	p
$\Delta T$ Sc	0.960 244	0.922 068	0.905 020	6659. 699	7	951.3 856	562.8 720	32	17.58 975	54.08 750	0.00000 0
$\Delta T P$	0.817 079	0.667 618	0.596 393	1868. 319	6	311.3 866	930.1 677	28	33.22 027	9.373 390	249.949 003

## Appendix IV

Table IV.73: Homogeneity of variances for Main ANOVA.

test	Factors	Levene's Test for Homogeneity of Variances				Tests of Homogeneity of Variances				
		MS Effect	MS Error	F	P	Hartley F-max	Cochran C	Bartlett Chi-Sqr.	df	P
ΔT SC	Treatments	38.7293 2	14.3057 6	2.70725 4	0.06220 2	6.03232 6	0.45751 5	8.18027 5	3	0.04242 9
	Additives	81.4246 8	27.2029 7	2.99322 7	0.09295 7	1.79502 6	0.64222 2	1.35841 1	1	0.24381 3
ΔT P	Treatments	181.876 5	9.34280 4	19.4670 1	0.00000 0	15.7948 8	0.71303 7	18.2377 6	3	0.00039 3
	Additives	30.9408 1	53.5253 9	0.57805 9	0.45176 6	1.36999 5	0.57805 8	0.45679 0	1	0.49912 8

Table IV.74: Homogeneity of variances for Factorial ANOVA.

test	Factors	Levene's Test for Homogeneity of Variances				Tests of Homogeneity of Variances				
		MS Effect	MS Error	F	P	Hartley F-max	Cochran C	Bartlett Chi-Sqr.	df	P
ΔT SC	A	38.7293 2	14.3057 6	2.70725 4	0.06220 2	6.03232 6	0.45751 5	8.18027 5	3	0.04242 9
	B	81.4246 8	27.2029 7	2.99322 7	0.09295 7	1.79502 6	0.64222 2	1.35841 1	1	0.24381 3
	AB	32.3504 6	11.6509 2	2.77664 5	0.03020 9	93.0050 4	0.71471 0	23.3585 8	6	0.00068 5
ΔT P	A	181.876 5	9.34280 4	19.4670 1	0.00000 0	15.7948 8	0.71303 7	18.2377 6	3	0.00039 3
	B	30.9408 1	53.5253 9	0.57805 9	0.45176 6	1.36999 5	0.57805 8	0.45679 0	1	0.49912 8
	AB	3.48022 3	3.92424 0	0.88685 3	0.52801 4	4.60651 7	0.22604 1	3.69889 6	7	0.81373 2

# Appendix IV

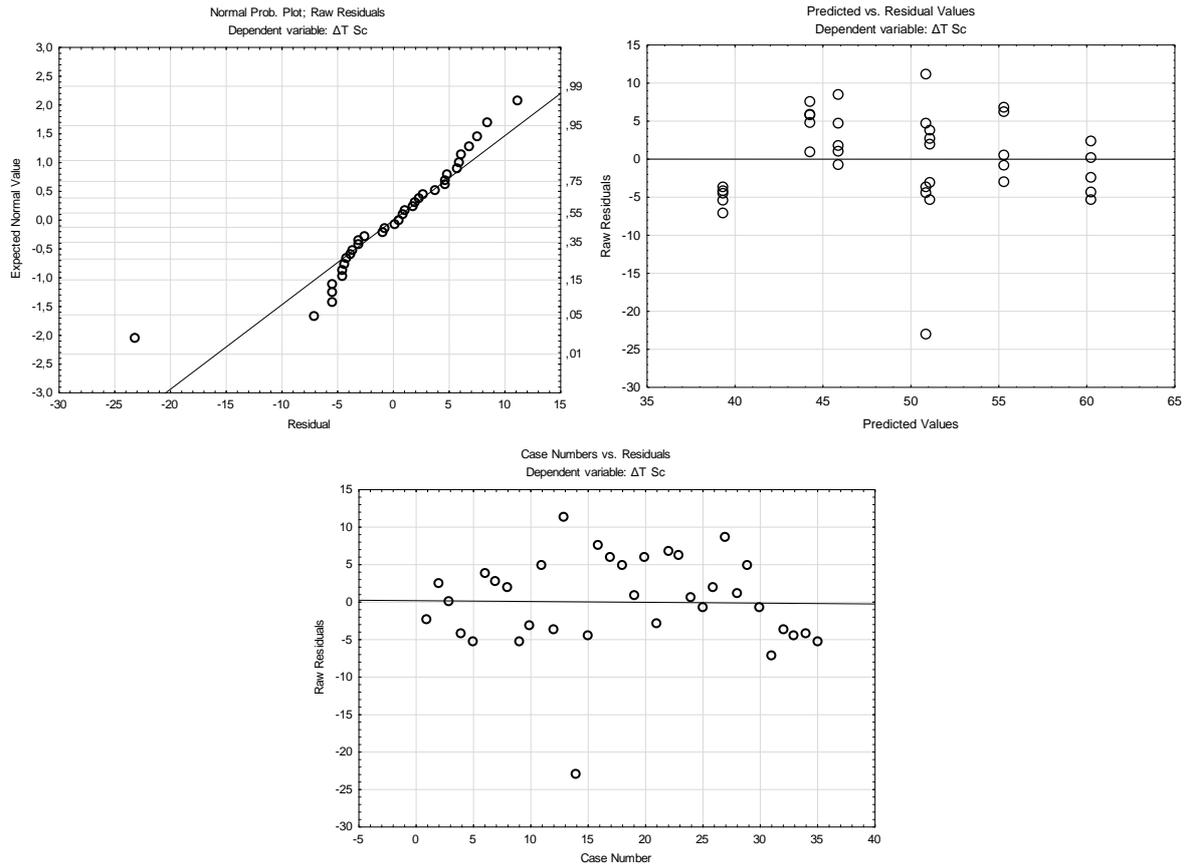


Figure IV.32: The normality of the distribution of residuals for  $\Delta T Sc$  of Main Anova

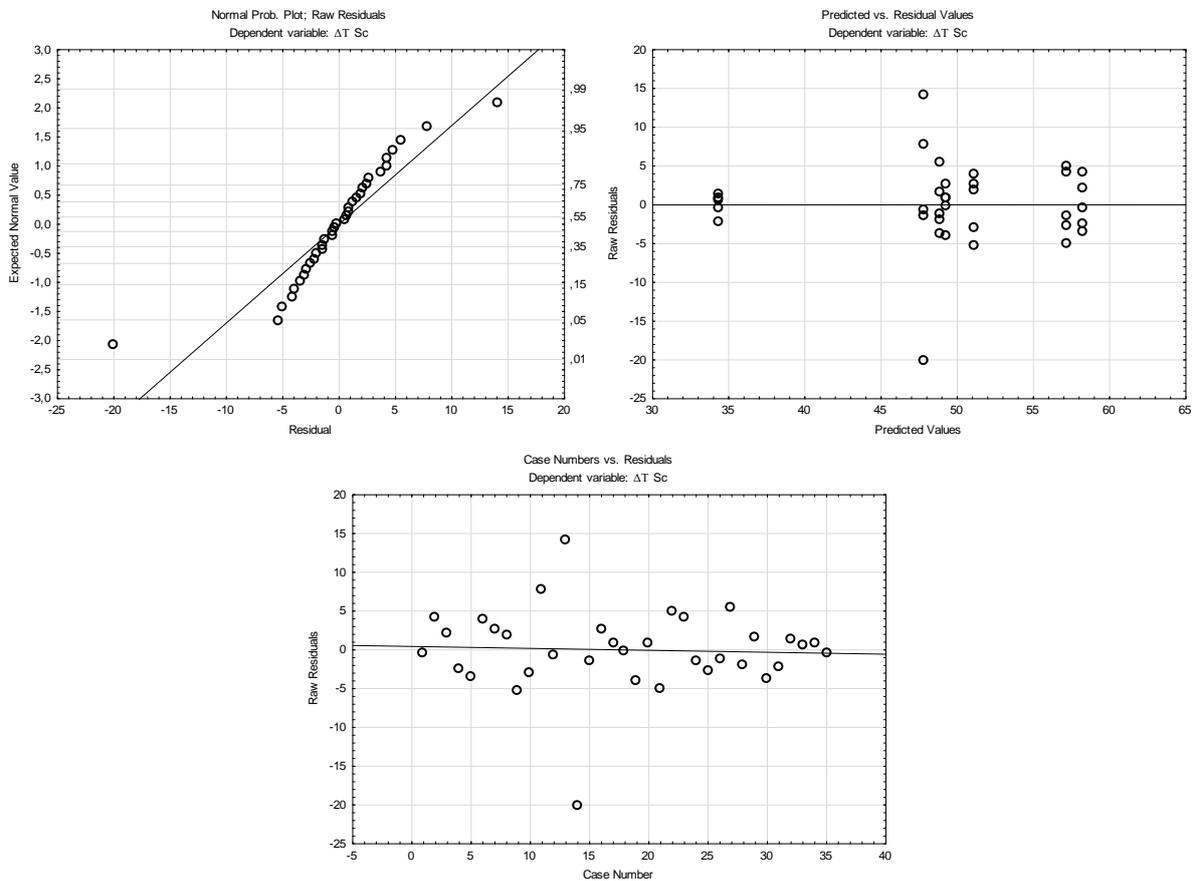


Figure IV.33: The normality of the distribution of residuals for  $\Delta T P$  of Factoriel ANOVA

# Appendix IV

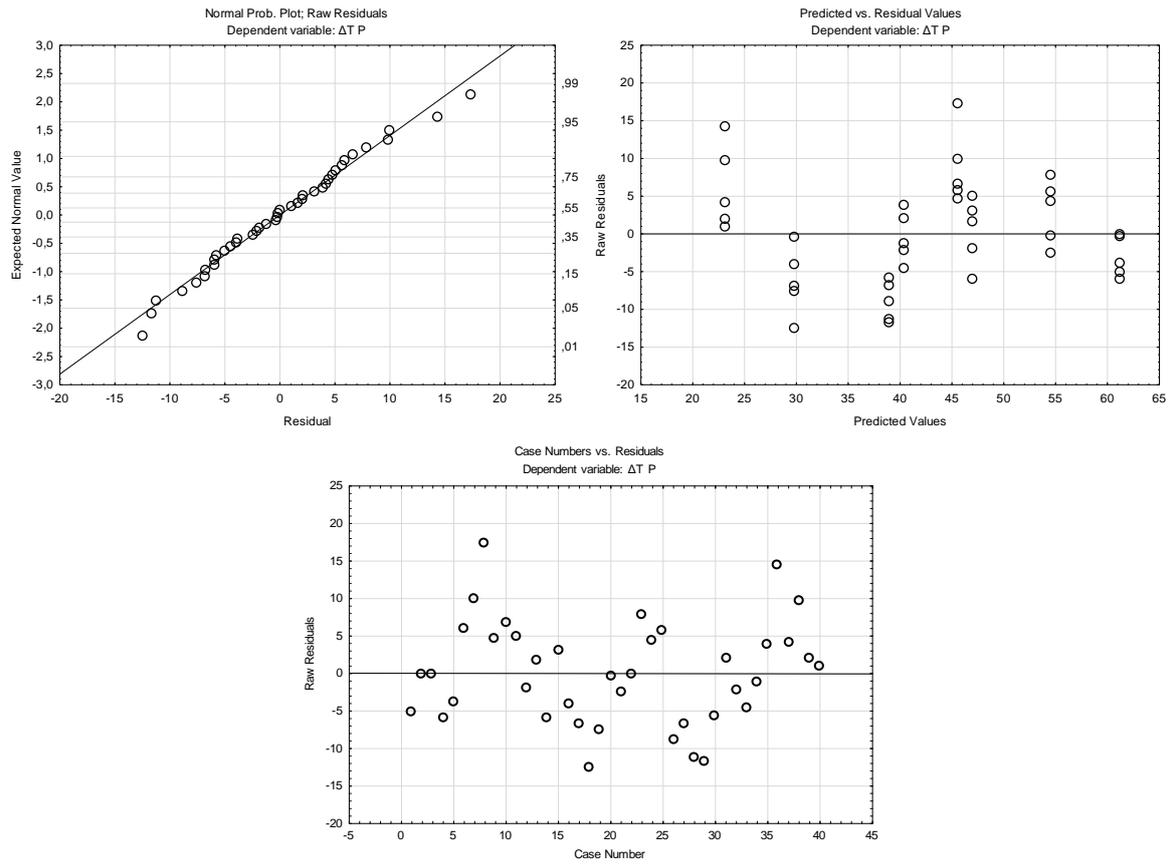


Figure IV.34: The normality of the distribution of residuals for  $\Delta T P$  of Main Anova

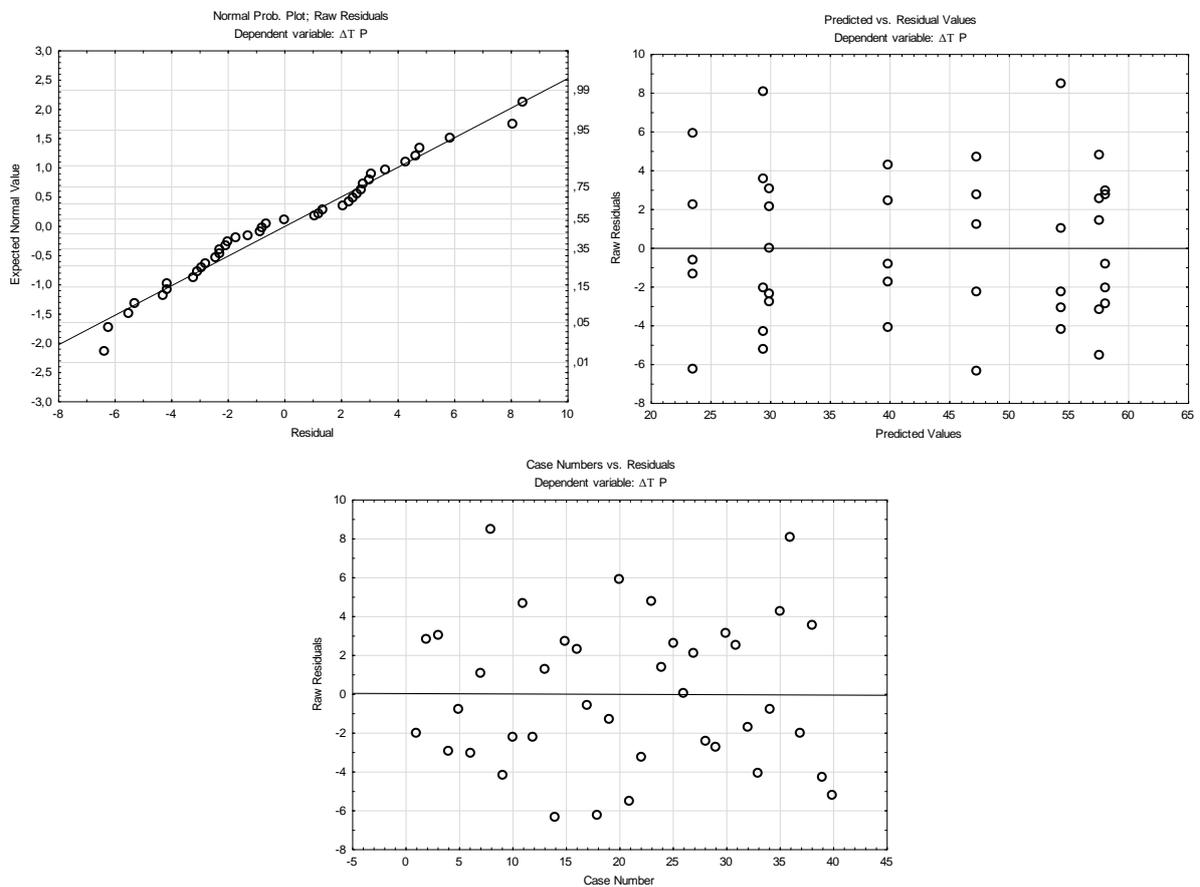


Figure IV.35: The normality of the distribution of residuals for  $\Delta T P$  of Factorial Anova

## Appendix IV

Table IV.75: Newman-Keuls test. Variable  $\Delta T$  Sc for Treatment Sc with Main and Factorial ANOVA.

Cell No.	Treatment Sc	Newman-Keuls test; variable $\Delta T$ Sc. Approximate Probabilities for Post Hoc Tests Error: Between MSE = 43.687. df = 30.000 (Main ANOVA)				Newman-Keuls test; variable $\Delta T$ Sc (Spreadsheet464) Approximate Probabilities for Post Hoc Tests Error: Between MSE = 33.220. df = 28.000 (Factorial ANOVA)			
		{1} 57.774	{2} 51.080	{3} 48.370	{4} 41.800	{1} 57.774	{2} 51.080	{3} 48.370	{4} 41.800
1	No treatment		0.051901	0.021085	0.000345		0.027801	0.008014	0.000191
2	Borax	0.051901		0.418826	0.023034	0.027801		0.355213	0.008905
3	DSHP 77g/l	0.021085	0.418826		0.056125	0.008014	0.355213		0.030564
4	DAHP150 g/l	0.000345	0.023034	0.056125		0.000191	0.008905	0.030564	

Table IV.76: Newman-Keuls test. Variable  $\Delta T$  Sc for Additive Sc with Main and Factorial ANOVA.

Cell No.	Additives Sc	Newman-Keuls test; variable $\Delta T$ Sc (fire test) Approximate Probabilities for Post Hoc Tests Error: Between MSE = 43.687. df = 30.000 (Main ANOVA)		Newman-Keuls test; variable $\Delta T$ Sc Approximate Probabilities for Post Hoc Tests Error: Between MSE = 33.220. df = 28.000 (Factorial ANOVA)	
		{1} 51.620	{2} 46.829	{1} 51.620	{2} 46.829
1	SS				0.042319
2	PDDA+MM	0.042319			0.021724

Table IV.77: Newman-Keuls test. Variable  $\Delta T$  Sc for interaction of factor AB with Factorial ANOVA.

Cell No.	Treatment Sc	Additives Sc	Newman-Keuls test; variable $\Delta T$ Sc. Approximate Probabilities for Post Hoc Tests Error: Between MSE = 33.220. df = 28.000 (Factorial ANOVA)							
			{1} 58.320	{2} 57.228	{3} 51.080	{4} ----	{5} 47.800	{6} 48.940	{7} 49.280	{8} 34.320
1	No treatment	SS		0.766850	0.134416		0.072621	0.103216	0.085358	0.000149
2	No treatment	PDDA+MM	0.766850		0.102954		0.100499	0.128728	0.092304	0.000141
3	Borax	SS	0.134416	0.102954			0.805058	0.828205	0.625439	0.000850
4	Borax	PDDA+MM								
5	DSHP 77g/l	SS	0.072621	0.100499	0.805058			0.756929	0.913503	0.001081
6	DSHP 77g/l	PDDA+MM	0.103216	0.128728	0.828205		0.756929		0.926457	0.001256
7	DAHP150 g/l	SS	0.085358	0.092304	0.625439		0.913503	0.926457		0.001820
8	DAHP150 g/l	PDDA+MM	0.000149	0.000141	0.000850		0.001081	0.001256	0.001820	

Table IV.78: Newman-Keuls test. Variable  $\Delta T$  P for Treatment P with Main and Factorial ANOVA.

Cell No.	Treatment Sc	Newman-Keuls test; variable $\Delta T$ P (fire test) Approximate Probabilities for Post Hoc Tests Error: Between MSE = 52.539. df = 35.000 (Main ANOVA)				Newman-Keuls test; variable $\Delta T$ P (Spreadsheet464) Approximate Probabilities for Post Hoc Tests Error: Between MSE = 17.590. df = 32.000 (Factorial ANOVA)			
		{1} 57.820	{2} 42.230	{3} 43.650	{4} 26.440	{1} 57.820	{2} 42.230	{3} 43.650	{4} 26.440
1	No treatment		0.000196	0.000220	0.000160		0.000123	0.000134	0.000165
2	Borax	0.000196		0.664159	0.000143	0.000123		0.454679	0.000134
3	DSHP 77g/l	0.000220	0.664159		0.000137	0.000134	0.454679		0.000123
4	DAHP150 g/l	0.000160	0.000143	0.000137		0.000165	0.000134	0.000123	

## Appendix IV

Table IV.79: LSD test. Variable  $\Delta T P$  for Additive P with Main and Factorial ANOVA.

Cell No.	Additives Sc	LSD test; variable $\Delta T P$ (fire test) Approximate Probabilities for Post Hoc Tests Error: Between MSE = 52.539. df = 35.000 (Main ANOVA)		LSD test; variable $\Delta T Sc$ Approximate Probabilities for Post Hoc Tests Error: Between MSE = 33.220. df = 28.000 (Factorial ANOVA)	
		{1} 45.865	{2} 39.205	{1} 45.865	{2} 39.205
1	SS		0.006316		0.000019
2	PDDA+MM	0.006316	78	0.00001976	

Table IV.80: LSD test. Variable  $\Delta T P$  for interaction of factor AB with Factorial ANOVA.

Cell No.	Treatment P	Additives P	LSD test; variable $\Delta T P$ Approximate Probabilities for Post Hoc Tests Error: Between MSE = 17.590. df = 32.000 (Factorial ANOVA)							
			{1} 58.120	{2} 57.520	{3} 54.460	{4} 30.000	{5} 47.360	{6} 39.940	{7} 23.520	{8} 29.360
1	No treatment	SS		0.822485	0.177209	0.000000	0.000299	0.000000	0.000000	0.000000
2	No treatment	PDDA+MM	0.822485		0.257201	0.000000	0.000563	0.000000	0.000000	0.000000
3	Borax	SS	0.177209	0.257201		0.000000	0.011628	0.000005	0.000000	0.000000
4	Borax	PDDA+MM	0.000000	0.000000	0.000000		0.000000	0.000708	0.020268	0.810878
5	DSHP 77g/l	SS	0.000299	0.000563	0.011628	0.000000		0.008649	0.000000	0.000000
6	DSHP 77g/l	PDDA+MM	0.000000	0.000000	0.000005	0.000708	0.008649		0.000001	0.000362
7	DAHP150 g/l	SS	0.000000	0.000000	0.000000	0.020268	0.000000	0.000001		0.035016
8	DAHP150 g/l	PDDA+MM	0.000000	0.000000	0.000000	0.810878	0.000000	0.000362	0.035016	